

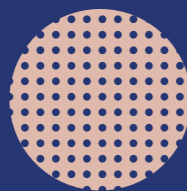

light
forms
life

AQFORM
LIGHTING SOLUTIONS



light forms life

Light is essential to all functions of life. Artificial light allows us to control all aspects of human activity. Intelligently considered lighting makes our actions defined and precise. Some sections of the colour spectrum enhance our perception of shape, contour and detail. Lighting of our interior environments affects our moods throughout the day and night cycle. Light is therefore a key factor in stimulating both effective work and relaxation. Light brings matter out of the dark. Light causes shadows and gives three-dimensionality to form. Light creates sensation in our environments. Light defines space.

Lighting products are the vehicles that deliver appropriate lighting – the right light that is required for specific tasks or effects. The light source in itself is only a part of a carefully conceived system that determines the amount, direction and quality of emitted light. Our ambition and focus is to create lighting solutions that are truly contemporary and that combine functional lighting with design elegance.

content

recessed / wpuszczane	040
surface / natynkowe	102
suspended / zwieszane	168
spot / reflektory	226
wall / kinkiety	286
ip rated / o podwyższonej szczelności	348
systems / systemy	386
index / indeks	426

light forms life

Światło jest nam niezbędne do poprawnego funkcjonowania. Sztuczne oświetlenie daje kontrolę nad czasem ludzkiej aktywności. Właściwie dobrane, czyni działania bardziej precyzyjnymi: niektóre barwy, detale i krawędzie można dostrzec tylko w dobrym świetle. Oświetlenie we wnętrzach wpływa na komfort naszego życia zarówno w dzień jak i w nocy. Ma znaczenie zarówno dla efektywnej pracy jak i wypoczynku. Światło wydobywa przedmioty z ciemności. Malując cienie, podkreśla trójwymiarowość form. Nadaje blask otoczeniu. Światło pomaga oswoić przestrzeń.

Oprawy oświetleniowe mają ogromne znaczenie dla uzyskania właściwego oświetlenia: optymalnie dobranego do zadanej funkcji lub efektu. Źródło światła jest tylko częścią starannie opracowanego systemu, który zapewnia odpowiednią ilość i jakość światła we właściwym miejscu i czasie. Dlatego skupiamy się na tworzeniu dopełniających się rozwiązań, pozwalających wykreować światłem pożądaną atmosferę. Rozwiązań użytecznych i estetycznych: nowoczesnego oświetlenia o zdefiniowanej funkcji zamkniętej w eleganckiej formie.

light
forms
residential
office
hospitality
retail

Passion for light

Check out five worth-knowing facts about AQForm:

1. We are an award-winning Polish manufacturer of modern lighting solutions.
2. In our portfolio you can find refined lighting dedicated to private interiors as well as specialized solutions to commercial spaces.
3. Our lighting fixtures are designed, tested, examined and manufactured in Czernichów near Kraków.
4. AQForm team of experts works every day at the 3600m² Research and Development Center.
5. The knowledge and experience of our employees, as well as the extensive machinery park, allow us to maintain high production flexibility.

Poznaj pięć ważnych faktów o AQForm:

1. Jesteśmy nagradzonym polskim producentem nowoczesnych rozwiązań oświetleniowych.
2. W naszym portfolio można znaleźć zarówno dopracowane oświetlenie do wnętrz prywatnych, jak i wyspecjalizowane rozwiązania do przestrzeni komercyjnych.
3. Nasze oprawy oświetleniowe są projektowane, testowane, badane i produkowane w Czernichowie nieopodal Krakowa.
4. Zespół ekspertów AQForm na co dzień działa w liczącym blisko 3600m² Centrum Badawczo-Rozwojowym.
5. Wiedza i doświadczenie naszych pracowników oraz rozbudowany park maszynowy pozwalają nam zachować dużą elastyczność produkcji.



Created
for you

Our journey

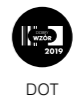
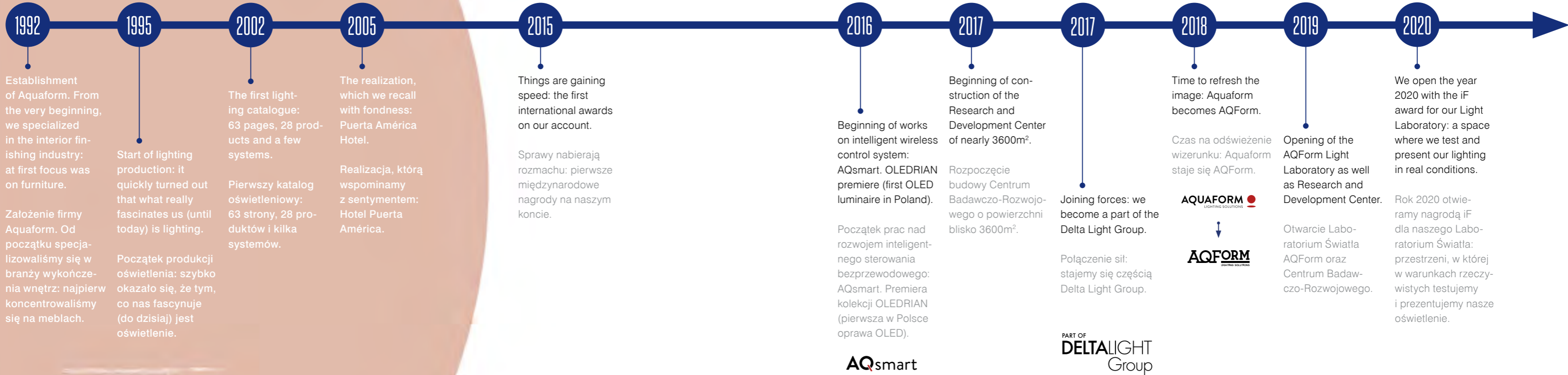



**Discover
the AQForm
world**



Hard Rock Cafe Wrocław



Poznań | photo: Weronika Trojanowska



More than just a shape

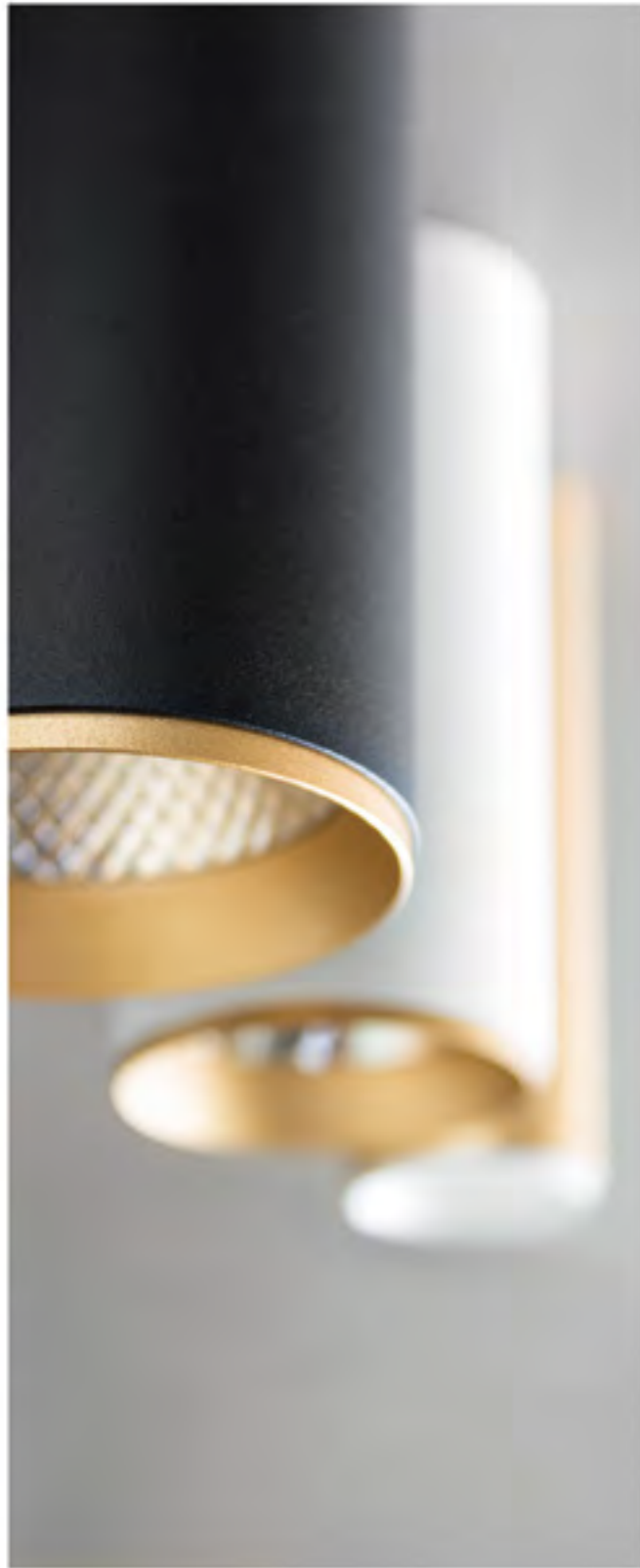

In the era of advanced LED technology and intelligent control systems or complex optical systems, the most important thing is a balanced combination of form and technology in such a way, that they complement each other.

An example of a successful duo of technology and design is the new generation of PET lighting fixtures, in which the decorative ring plays a dual role: it increases the shielding angle and at the same time allows you to play with the finish of the product.

W dobie zaawansowanej technologii LED i inteligentnych systemów sterowania czy złożonych układów optycznych, najważniejsze jest wyważone połączenie formy i technologii w taki sposób, aby wzajemnie się uzupełniały.

Przykładem udanego duo technologii i wzornictwa jest nowa generacja opraw PET, w której ozdobny pierścień pełni podwójną rolę: powiększa kąt ochrony i jednocześnie pozwala na zabawę z wykończeniem produktu.

Visual comfort



We are constantly improving our products because we know how important lighting is for visual comfort. Especially in places like offices, where we spend many hours. That is why we have introduced even more luminaires, using which low glare is easily achievable. The development of optical constructions has resulted in solutions with an increased angle of protection and more precise light emission, which translates into an increased visual comfort.

Solutions which make glare reduction the easiest are marked with special UGR icon.

Stale doskonalimy nasze produkty, ponieważ wiemy jak ważne jest oświetlenie dla komfortu wizualnego. Szczególnie w miejscach takich jak biura, gdzie spędzamy wiele godzin. Dlatego wprowadziliśmy jeszcze więcej opraw, z którymi osiągnięcie niskiego oślnienia jest łatwe. Rozwój konstrukcji optycznych zaowocował rozwiązaniami o zwiększonym kącie ochrony i bardziej precyzyjnej emisji światła, co przekłada się na powiększenie strefy komfortu wizualnego.

Rozwiązania, dzięki którym redukcja oślnienia jest najłatwiejsza są oznaczone specjalną ikoną UGR.

Take control over your light

AQsmart

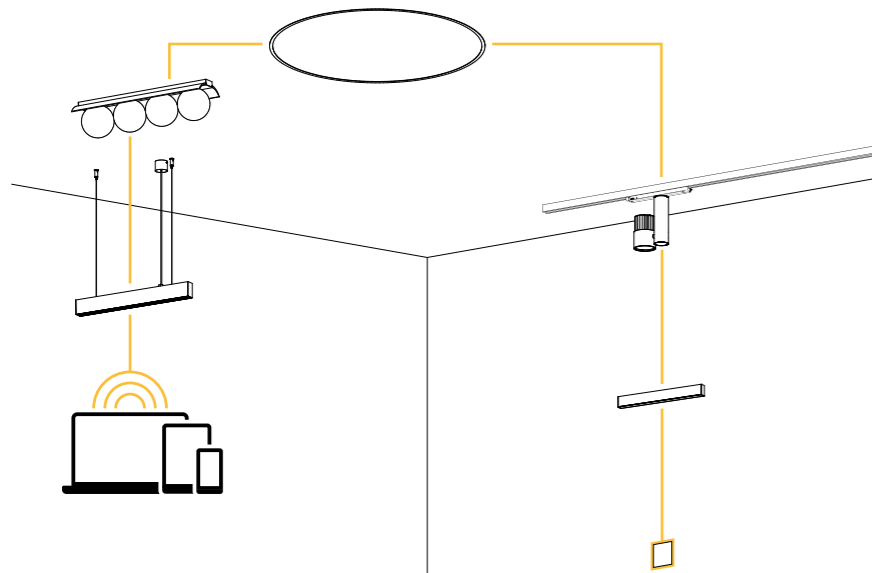

Control your light from your pocket

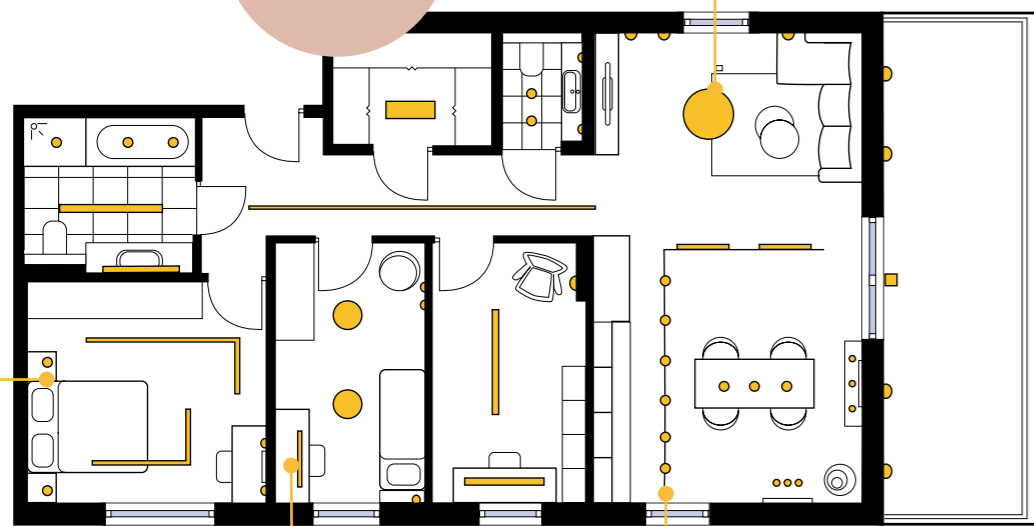

use proper light to master your concentration while working or studying

użyj odpowiedniego światła, aby poprawić koncentrację podczas pracy lub nauki

program you kitchen light to turn on when you get up, so you never enter a dark kitchen in the morning

zaprogramuj światło kuchenne tak, aby włączało się, gdy wstajesz, żeby nigdy nie wchodzić do ciemnej kuchni o poranku

Lighting can be controlled. Starting with the ability to adjust the light intensity from twilight to full brightness, up to setting complex lamp configurations tailored to our daily rhythm.

It can optimize the energy consumption and make real **energy savings: from over a dozen up to even 80%** if presence and illuminance sensors are used. AQsmart wireless control goes even a step further. It allows you to **control the lighting from your smartphone!**

Oświetleniem można sterować. Od możliwości regulacji natężenia oświetlenia z półmroku do pełnej jasności czy też do ustawienia złożonych konfiguracji lamp dostosowanych do naszego rytmu dobowego.

Dzięki sterowaniu można **zmniejszyć zużycie energii: od kilkunastu do nawet 80%**, przy zastosowaniu czujników obecności i natężenia oświetlenia. Sterowanie bezprzewodowe AQsmart idzie jeszcze o krok dalej. Pozwala **sterować oświetleniem z poziomu smartfona!**

create separate lighting stages for reading a book, watching a movie or playing board games

stwórz oddzielne sceny oświetleniowe do czytania książki, oglądania filmu lub grania w gry planszowe

in your bedroom, light can wake you up with high colour temperature, which affects you - similarly to having a cup of coffee and then, in the evening warm light can calm you down

światło w naszej sypialni może obudzić nas wysoką temperaturą barwową, która zadziała energetyzująco jak filiżanka kawy, z kolei wieczorem ciepłe światło uspokoi nas i wyciszy

The colour temperature matters

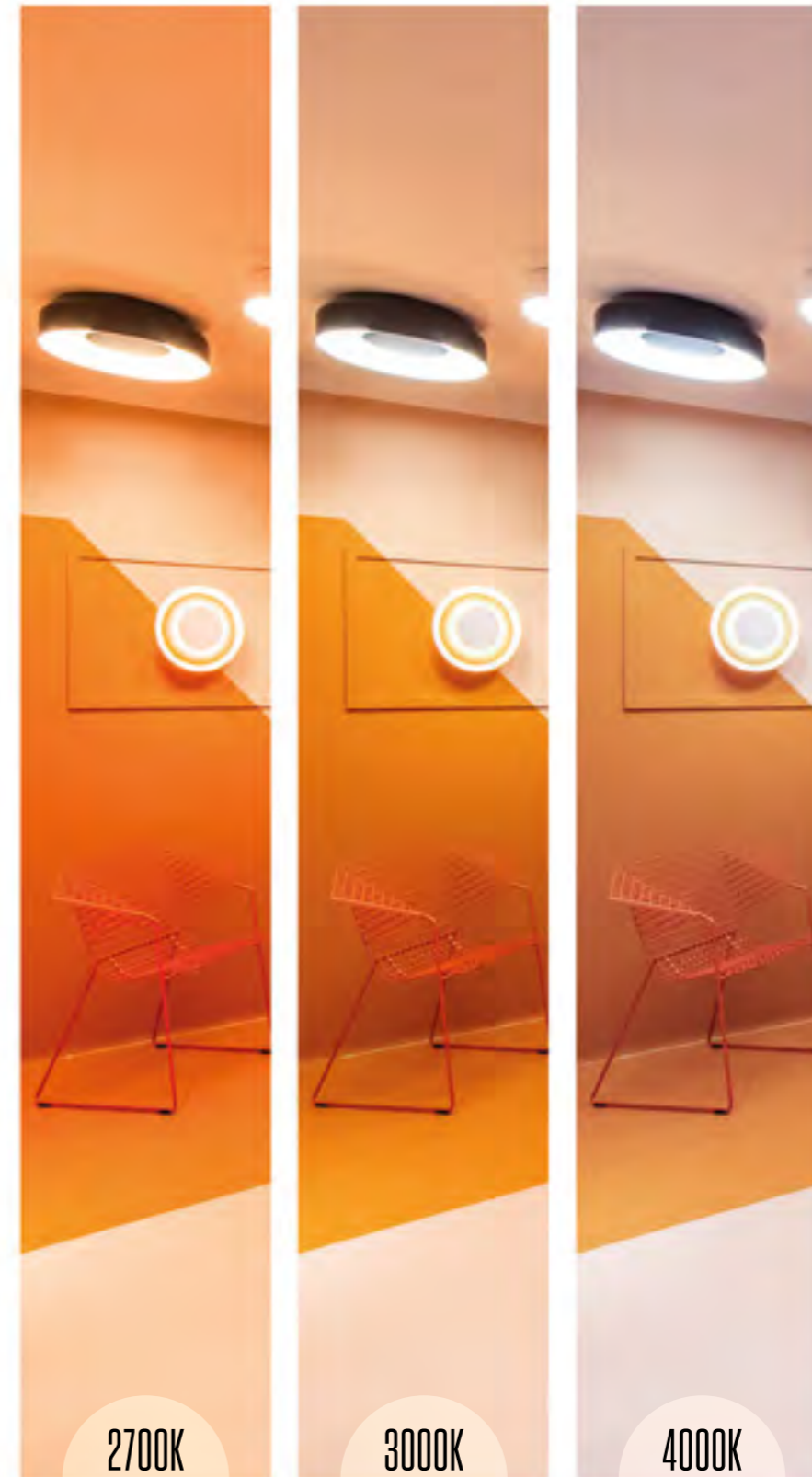

Warm light makes the interior more cozy and our thoughts calmer. It emphasizes the warm colours of wood or fabric, just like the setting sun.

Cool light puts the body in a state of readiness. It awakens and sobers up like a cold shower. High colour temperatures correspond with the tone of sunlight at noon. In the cool light we see very clearly, and our body and mind are ready for effort.

Ciepłe światło sprawia, że wewnątrz jest bardziej przytulne, a nasze myśli spokojniejsze. Podkreśla ciepłe kolory drewna czy tkanin, zupełnie jak zachodzące słońce.

Chłodne światło stawia organizm w stan gotowości. Rozbudza i otrzeźwia niczym zimny prysznic. Wysokie temperatury barwowe odpowiadają barwie światła słonecznego w południe. W chłodnym świetle widzimy bardzo wyraźnie, a ciało i umysł są gotowe do wysiłku.

2700K

3000K

4000K

What is new

1

Simplified offer = faster choice

Our standard offer contains only carefully selected lighting fixtures, while new products offer even more functions. In practice it means easier and faster choice.

W standardowej ofercie pozostawiliśmy starannie wyselekcjonowane oprawy, a nowe produkty zaskoczą mnogością funkcji. W praktyce oznacza to jeszcze łatwiejszy i szybszy wybór.

2

Updated colour palette

White and black are our standard, which since 2020 is available in the structural version.

Biały i czarny to nasz standard, który od 2020 dostępny jest w wersji strukturalnej.

3

Visual comfort as a priority

We are expanding families of luminaires with increased protection angle. Recessed light source, microprismatic covers, hybrid optics... the entire 'avenue of stars' is gathered to take care of your eyesight at any time of the day.

Poszerzamy rodziny opraw o podwyższonym kącie ochrony. Zagłębione źródło światła, przestony mikropryzmatyczne, hybrydowa optyka... cała „plejada gwiazd” zebrana po to, by dbać o wzrok o każdej porze dnia.

4

Next generation: PET next

Similar appearance, three sizes and extended functionality. Worth to check its features!

Podobny wygląd, trzy rozmiary i rozszerzona funkcjonalność. Warto sprawdzić co potrafi!

5

Next generation: SQUARES and TUBA

Uniform design, solid construction and durability. In the new version with improved efficiency and reduced flicker.

Jednolity wygląd, solidna konstrukcja i trwałość. W nowej odsłonie z poprawioną wydajnością i zredukowanym tętnieniem.

6

MODERN BALL

Beauty was taken care of by DECHEM design studio, technology – by AQForm engineers. Architectural lighting means a combination of beautiful form and functionality.

O piękno zadbało studio projektowe DECHEM, o technologię – inżynierowie AQForm. Bo oświetlenie architektoniczne oznacza połączenie piękna formy z funkcjonalnością.

7

MULTITRACK

The synergy of aesthetics and technology is our specialty. The functionality of luminaires for tracks has been combined with the minimalist aesthetics of MULTITRACK. Perfect duo.

Synergia estetyki i technologii to nasza specjalność. Funkcjonalność opraw do szynoprzewodów została połączona z minimalistyczną estetyką MULTITRACK. Idealny duet.

8

A variety of downlights

Larger, smaller, movable, immovable – the whole range of downlight luminaires completes our offer. The smallest has a diameter of only 40mm, the largest... check it out!

Większe, mniejsze, ruchome, nieruchome – cała gama opraw typu downlight uzupełnia naszą ofertę. Najmniejsza z nich ma średnicę zaledwie 40mm, największa... sprawdź!

5 years
warranty
for LED
luminaires

Finishes

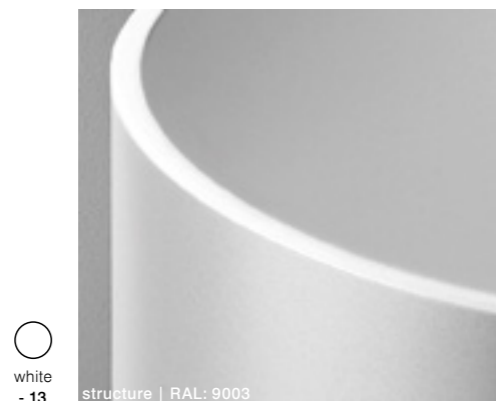
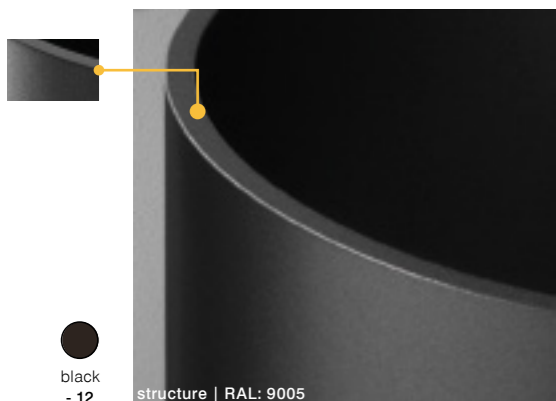

Since 2020, we offer as a standard a white and black finish in the structural version, which is characterized by higher resistance and easier maintenance. Additionally on request, our luminaires can be painted in any RAL or NCS colour!

Od 2020 roku proponujemy jako standard wykończenie białe i czarne w wersji strukturalnej, która charakteryzuje się wyższą odpornością na uszkodzenia i zabrudzenia. Dodatkowo na zamówienie, nasze oprawy możemy lakierować na dowolny kolor RAL lub NCS!

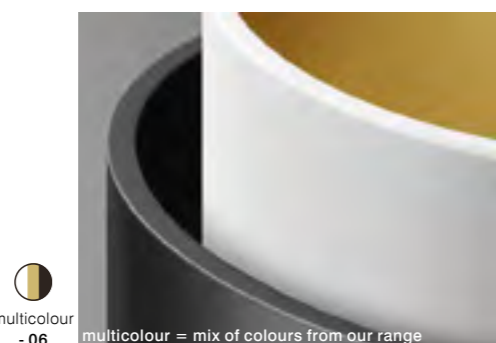
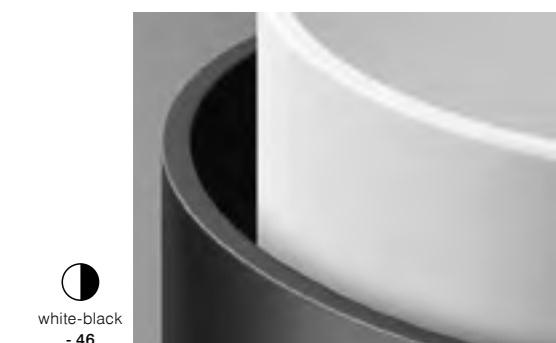
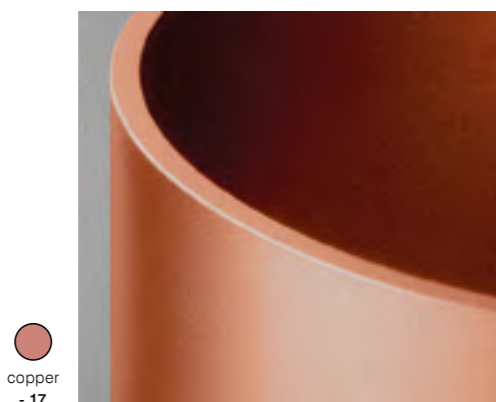
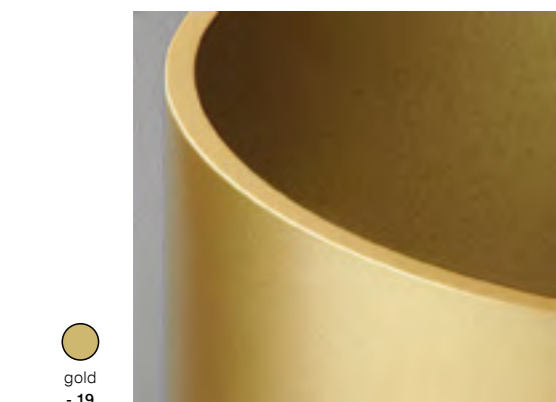

Any RAL or NCS on request
Dowolny RAL lub NCS na zapytanie

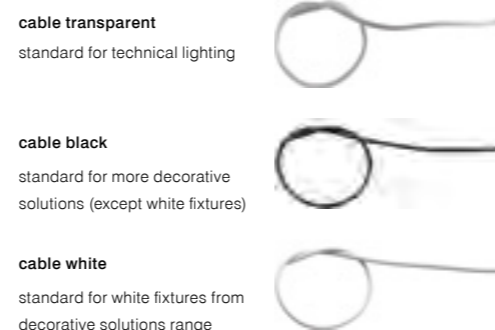

Catalogue overview

Time to simplify! At first glance, you can see here fewer numbers than in the 2018 edition, but the amount of information is the same (or even larger). All thanks to transferring information about the catalogue number configuration to the handy fold at the end of the catalogue.

The 2020 catalogue shows a cross-section of our offer. The full offer and always up-to-date product information are available at www.aqform.com.

Pora na uproszczenia! Na pierwszy rzut oka widać tu mniej cyfr niż w edycji 2018, ale ilość informacji jest taka sama (a czasem nawet większa). Wszystko dzięki przeniesieniu informacji o konfiguracji numeru katalogowego do podręcznej zakładki na końcu katalogu.

Katalog 2020 pokazuje przekrój naszej oferty. Pełna oferta i zawsze aktualne informacje o produktach są dostępne na stronie internetowej www.aqform.com.

handy fold
at the end of the catalogue there is an instruction on how to configure the catalogue number
podręczna zakładka
na końcu katalogu znajduje się instrukcja jak można skonfigurować numer katalogowy

MODERN BALL
NEW

standard type

LED type	Power	Beam	Light	Color	Mounting
MODERN BALL NP v4 LED suspended	18 W	2800K	1770mm	180°	...
MODERN BALL NP v4 LED suspended	30 W	2800K	1770mm	180°	...
MODERN BALL NP v4 LED suspended	30 W	3000K	1770mm	180°	...
MODERN BALL NP v4 LED suspended	30 W	4000K	1770mm	180°	...
MODERN BALL NP v4 LED suspended	30 W	5000K	1770mm	180°	...
MODERN BALL NP v4 LED asymmetric suspended	18 W	2800K	1800mm	180°	...
MODERN BALL NP v4 LED asymmetric suspended	30 W	2800K	1800mm	180°	...
MODERN BALL NP v4 LED asymmetric suspended	30 W	3000K	1800mm	180°	...
MODERN BALL NP v4 LED asymmetric suspended	30 W	4000K	1800mm	180°	...
MODERN BALL NP v4 LED asymmetric suspended	30 W	5000K	1800mm	180°	...

finishes

standard: structure (black, white), additional (gold, copper, grey, multicolour)

LED integrations

all versions

Configure your product using the LED cut or our website.

How to set up the catalogue number?
Jak skonfigurować numer katalogowy?

Formal number of the catalogue contains information on the most important technical parameters of the luminaire. Information marked in black refers to fixed (unchangeable) luminaire parameters. Information marked in green refers to optional (changeable) luminaire parameters.

12345-M930-F1-PH-03

beam angle / light distribution

180°
120°
90°
60°
30°

illustrative product photo
illustration of an example of product appearance or use
przykładowe zdjęcie produktu
ilustracja przykładowego wyglądu lub wykorzystania produktu

products group name
nazwa grupy produktów

other assembly version
one family of luminaires, different mounting options – it's worth checking out
inna wersja montażu
jedna rodzina opraw, różne możliwości mocowania – warto sprawdzić

tip: where the group works best
podpowiedź: gdzie grupa produktów sprawdza się najlepiej

standard luminaire types
regular parameters, available at standard time
typ standardowy opraw
standardowe parametry, dostępne w standardowym terminie

available finishes
for other finish than standard black and white structure lead time might be longer
dostępne wykończenia
w przypadku innych wykończeń niż standard: czarny i biały struktura czas oczekiwania może być dłuższy

overview of all options
przegląd wszystkich opcji



Piotr Jagiełłowicz

– We have created a product intended to be balanced, both literally and figuratively, in its form and design – says Piotr Jagiełłowicz about equilibra BALANS.

– Stworzyliśmy produkt, który miał być wyważony, dosłownie i w przenośni, w formie i konstrukcji – mówi o oprawie equilibra BALANS Piotr Jagiełłowicz.

Design

COOPERATIONS



MODERN GLASS | p.110 / 176 / 292 / 352



MODERN BALL | p.105 / 170 / 288

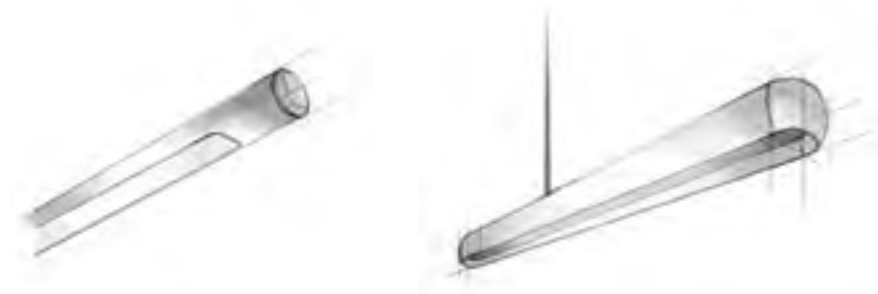

THIN TUBE | p.222 / 342 / 382

equilibra BALANS | p.204



– At first we were observing the play of light on the glass. Glass with proper thickness allows light to gently flow on the surface of the lighting fixture – say designers.

– Na początku obserwowaliśmy grę światła na szkło. Szkło o odpowiedniej grubości pozwala światłu delikatnie opływać powierzchnię oprawy – mówią projektanci.

DECHEM studio

Michaela Tomiskova and Jakub Jandourek



Delivery needed ASAP? No problem.

Time during project realization is of great importance. That is why:

- The most popular products – gathered in the QS quick shipment offer – will be sent ready from storage within 48h from confirmed order or we manufacture them up to 5 business days. We always confirm the time.
- We manufacture and ship standard luminaires within 15 business days from ordering.
- We manufacture luminaires in gloss finish within 20 working days.

The lead time for non-standard products depends on the selected parameters or the type of product modification.

Czas przy realizacji projektów ma duże znaczenie. Dlatego:

- Najpopularniejsze produkty – zebrane w ofercie szybkiej dostawy QS – wysyłamy gotowe z magazynu w ciągu 48h od potwierdzonego zamówienia lub wyprodukujemy do 5 dni roboczych. Zawsze potwierdzamy czas realizacji.
- Standardowe oprawy produkujemy i wysyłamy w 15 dni roboczych od zamówienia.
- Oprawy w wykończeniu połysk produkujemy w 20 dni roboczych.

Termin realizacji produktów niestandardowych zależy od wybranych parametrów lub rodzaju modyfikacji produktu.



48h of shipment for stock products

Search for **QS** mark
on our products

INDEX

- SPOT 
- TRACK 
- MULTITRACK 
- WALL 
- SUSPENDED 
- SURFACE 
- RECESSED 
- IP 
- SYSTEMS 



1000 / 2000



2000 PRO

1000 PRO



2000 P20



2000 P30

[236 / 238 / 240](#)

[236 / 238 / 240](#)

[236 - 238](#)



AQLED

[264](#)

[264](#)



BASET

[328](#)



BIG SIZE



ROUND



SQUARE



PRO

[200 - 202](#)

[142 - 144](#)

[078 - 080](#)



BLOS



ROUND



MINI



SQUARE

[370](#)



CADRA

[326](#)

[198](#)



CAMBER

[298](#)



CERES

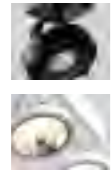

QRLED

AR111

[254-256](#)

[254-256](#)



equilibra

[338](#)

[204](#)

[146](#)



GLOB

[188](#)



GOLO

[294](#)

[350](#)



HOLLOW



MICRO

MINI



ROUND

[042](#)



KARI

[260](#)

[260](#)

[260](#)

[190](#)

[392-394](#)



LED EYE

[358](#)

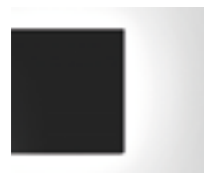

LEDPOINT / MAXI POINT



LEDPOINT ROUND

LEDPOINT SQUARE



MAXI POINT ROUND

MAXI POINT SQUARE

[306-308](#)

[392-394](#)



LENS LINE

208 148 082 402-410



MIXLINE

210 150 082 402-410



MAXI RING / REVEL

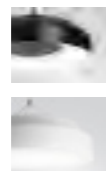

MAXI RING DOT

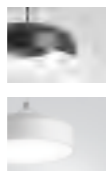

REVEL DOT



MAXI RING COVER



REVEL COVER

184 126 076



MINI CUBE / MAXI CUBE



MINI



MAXI

316

368



MODERN BALL

288

170

104



MODERN GLASS



FLARED



BARREL



TUBE

292

176-178

110-112

352

392-394



MORE



MINI



MIDI























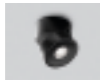



MAXI

052



MORPH

182

SPOT

TRACK

MULTITRACK

WALL

SUSPENDED

SURFACE

RECESSED

IP

SYSTEMS



ROLL

[266](#)

[266](#)



ROTTO

[244](#)

[244](#)



SET RAW MINI

[302](#)

[214](#)

[156](#)

[086](#)

[376](#)

[414](#)



SET TRU

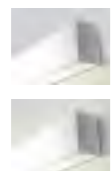

REGULAR



UP&DOWN

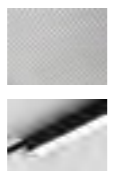

PRO



MINI

[272](#)

[332](#)

[218](#)

[164](#)

[098](#)

[378](#)

[416](#)



SIRCA



10



14

[044](#)



SLEEK



ORLED



AR111

[324](#)

[138](#)

[072](#)



SLIMMER

[374](#)



SMART PANEL



OVAL



SQUARE

[330](#)

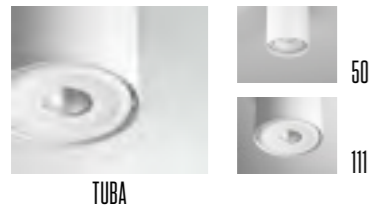

132-134

058-066

054

342

222

382

258

320

192

118 / 120 / 122

LIST OF PICTOGRAMS

- integrated light sources / zintegrowane źródła światła
- non-integrated luminaire (eg. AR111) / oprawa na wymienne źródło światła (np. AR111)
- input voltage / napięcie zasilające
- protection class / klasa ochronności
- direction of light output / kierunek świecenia oprawy
- mounting orientation / możliwe miejsce montażu lub lokalizacji oprawy
- minimum distance from illuminated object / minimalna odległość od oświetlanego obiektu
- ingress protection rating (...) / klasa szczelności oprawy (...)
- availability of control (standard / optional) / dostępność sterowania (w standardzie / w opcji)
- UGR value for a room that can be obtained using a given product / wartość UGR dla pomieszczenia jaką można uzyskać stosując dany produkt.

- high visual comfort and efficiency / wysoki komfort wizualny i wydajność
- high lumen output and easy maintenance / wysoki strumień świetlny i łatwość w utrzymaniu czystości
- high lumen output and precise optics / wysoki strumień świetlny i precyzyjna optyka
- pleasant look and relaxing lighting / przyjemny wygląd i odprężające światło
- perfect for dining tables and restaurant rooms / idealne nad stoły jadalne i do restauracji
- interior decoration, high usability as a standard / ozdoba wnętrza, wysoka użyteczność w standardzie
- efficient task lighting / wydajne oświetlenie zadaniowe
- high lumen output and efficiency / wysoki strumień świetlny i duża wydajność
- IP rated and suitable for bathrooms / podwyższony stopień IP, odpowiednie do łazienek
- suitable for outside use / odpowiednie do wykorzystania na zewnątrz budynku

AQsmart wireless lighting control based on network systems / bezprzewodowe sterowanie oświetleniem bazujące na systemach sieciowych

minimum space required for recessed luminaires mounting / minimalny obszar niezbędny do montażu opraw wpuszczanych

possibility of rotation of the luminaire element / możliwość obrotu elementu oprawy



RECESSED

RECESSED

HOLLOW micro
p. 042



new

HOLLOW mini
p. 042

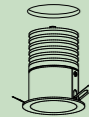

new

HOLLOW x1 round
p. 042



SIRCA
p. 044

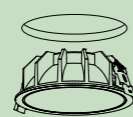

new

RING next 50
p. 046

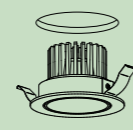

new

RING 111 QRLED trimless
p. 048

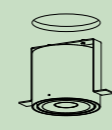

new

MINISQUARE x1
p. 070



MINISQUARE x2
p. 070

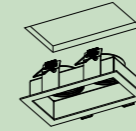

SLEEK 111x1 QRLED
p. 072

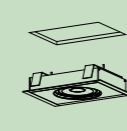

SLEEK 111x2 QRLED
p. 072

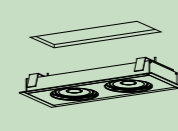

SLEEK 111x1
p. 072

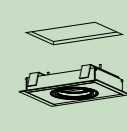

SLEEK 111x2
p. 072

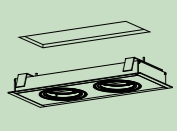

RING 111 QRLED
p. 048



RING 111 trimless
p. 048



RING 111
p. 048



MORE mini
p. 052

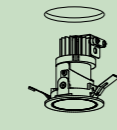

new

MORE midi
p. 052



new

MORE maxi
p. 052

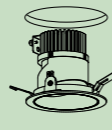

new

RING LED
p. 076

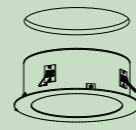

REVEL LED
p. 076

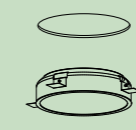

MAXI RING LED
p. 076

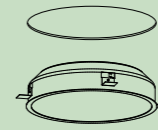

BIG SIZE next round
p. 078

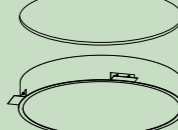

BIG SIZE PRO next round
p. 078

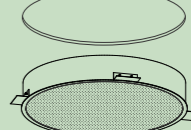

new

BIG SIZE next square
p. 080

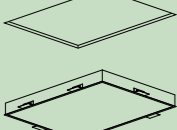

SWING 12 trimless
p. 054



SWING 24 trimless
p. 054



SQUARES next 50x1 trimless
p. 058

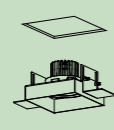

new

SQUARES next 50x1
p. 058

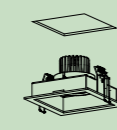

new

SQUARES next 50x2 trimless
p. 058

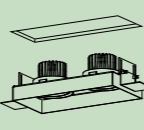

new

SQUARES next 50x2
p. 058

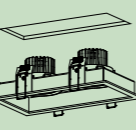

new

BIG SIZE PRO next square
p. 080

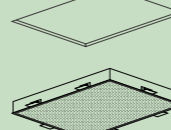

new

LENS LINE 43
p. 082

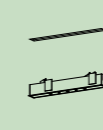

LENS LINE section
p. 082

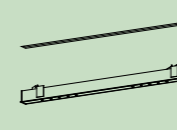

LENS LINE 180x89 RC
p. 082

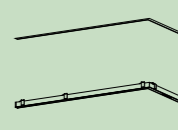

MIXLINE
p. 082

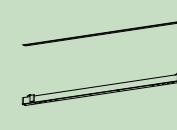

MIXLINE INV
p. 082

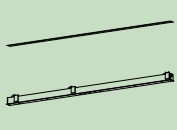

SQUARES 50x1 trimless
p. 060

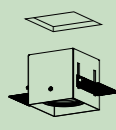

SQUARES 50x1
p. 060



SQUARES 50x2 trimless
p. 060

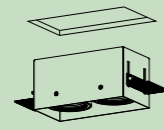

SQUARES 50x2
p. 060

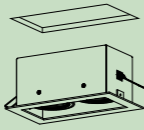

SQUARES 111x1 QRLED trimless
p. 064

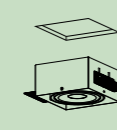

new

SQUARES 111x1 QRLED
p. 064

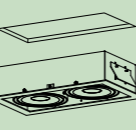

new

SET RAW mini
p. 086

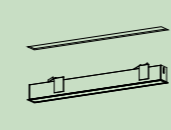

RAFTER points trim
p. 088

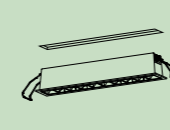

new

RAFTER wall washer trim
p. 090

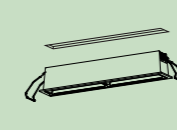

new

RAFTER mix
p. 092

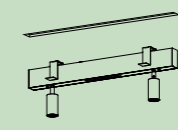

RAFTER
p. 094

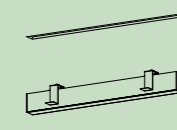

new

RAFTER points
p. 094

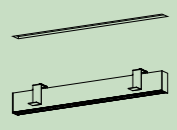

new

RAFTER points section
p. 094

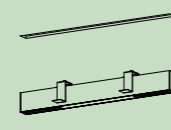

SET TRU
p. 098

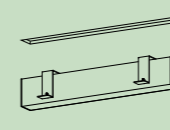

SET TRU PRO
p. 098

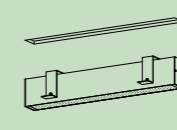

new

SQUARES 11x2 QRLED trimless
p. 064

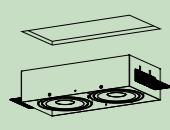

SQUARES 111x2 QRLED
p. 064

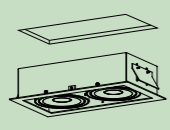

SQUARES 111x1 trimless
p. 066

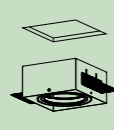

SQUARES 111x1
p. 066



SQUARES 111x2 trimless
p. 066

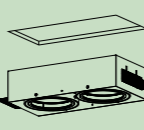

new

SQUARES 111x2
p. 066

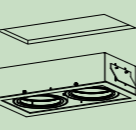

new

HOLLOW



HOLLOW is a discreet friend of every interior. The minimalist design and simplicity of its form make this luminaire correspond perfectly with most arrangements. The deeply recessed light source, for the sake of our visual comfort, guarantees a large protection angle. Three sizes allow you to create a variety of compositions using HOLLOW, and a discrete light source will add mood where it is needed. In the group, this luminaire can be used in communication spaces as general lighting, while solo it can become the right accenting solution.

HOLLOW to dyskretny przyjaciel każdego wnętrza. Minimalistyczny design oraz prosta forma sprawiają, że oprawa ta znakomicie koresponduje z większością aranżacji. Zagłębione źródło światła gwarantuje duży kąt ochrony, co bezpośrednio przekłada się na podniesienie komfortu wizualnego. Trzy wielkości pozwalają tworzyć różnorodne kompozycje z wykorzystaniem HOLLOW, a cofnięte źródło światła doda nastroju tam, gdzie jest to konieczne. W grupie oprawa znajdzie zastosowanie w przestrzeniach komunikacyjnych jako oświetlenie ogólne, solo będzie trafnym rozwiązaniem akcentującym.



standard type

NEW

HOLLOW micro LED recessed

aqform.com/HL0013

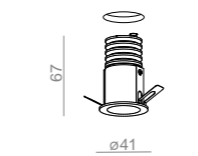

⌀35mm Hmin: 65mm

CRI>90 | 3000K | 30° | non dim

power	flux	cat. no
2.0W	210lm	37986-M930-F1-00-__

QS

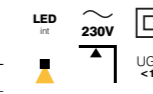

QS Q4 2020 white

NEW

HOLLOW mini LED recessed

aqform.com/HL1013

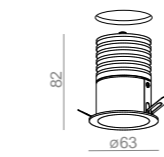

⌀54mm Hmin: 80mm

CRI>90 | 3000K | 24° | non dim

power	flux	cat. no
6.0W	800lm	37987-M930-S1-00-__

QS

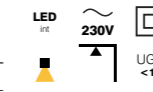

QS Q4 2020 black

QS Q4 2020 white

HOLLOW x1 round LED recessed

aqform.com/HL4213

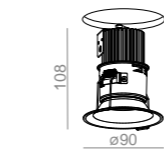

⌀82mm Hmin: 120mm

CRI>90 | 3000K | 36° | non dim

power	flux	cat. no
9.0W	1120lm	30254-M930-F1-00-__

QS

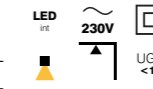

QS Q3 2020 black

QS Q3 2020 white

finishes

standard matt structure



additional



all versions

Configure your product using the fold-out or our website.

LED integrated

power: dependent on version

CRI: CRI>90

CCT: 3000K | 4000K

beam angle:

24° —

HOLLOW mini LED recessed

30° —

HOLLOW micro LED recessed

36° —

HOLLOW x1 round LED recessed

dimming optional:

Phase-Control | DALI | switchDIM —

HOLLOW x1 round LED recessed

new



Minimalist forms often build the uniqueness of the interior. After all, beauty lies in simplicity. SIRCA is a supporting hero who – thanks to its parameters – can both effectively light up the passage in dark corridors as well as highlight horizontal displays. It is also the right solution for large spaces, such as offices, hotels, lobbies and restaurants. In these places, an energy saving SIRCA of high luminous flux will be at an undoubted advantage.

Minimalistyczne formy często stanowią o niepowtarzalnym charakterze wnętrza. W końcu piękno tkwi w prostocie. SIRCA to drugoplanowy bohater, który, dzięki swym parametrom, może zarówno skutecznie rozświetlać przejścia ciemnych korytarzy, jak i podkreślać poziome ekspozyty. To także trafne rozwiązanie dla dużych przestrzeni, takich jak biura, hotele, lobby czy restauracje. W takich miejscach energooszczędność i wysoki strumień świetlny opraw SIRCA będą niewątpliwym atutem.



standard type

SIRCA 10 LED recessed

aqform.com/SC0013

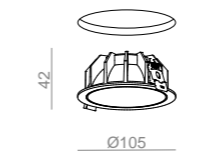

Ø105
Hmin: 45mm

CRI>90 | 3000K | 59° | non dim

power	flux	cat. no
8.5W	1170lm	37988-M930-W3-00-__



QS Q4 2020 black
QS Q4 2020 white

SIRCA 14 LED recessed

aqform.com/SC0013

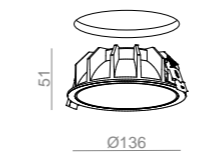

Ø136
Hmin: 55mm

CRI>90 | 3000K | 53° | non dim

power	flux	cat. no
12.0W	1570lm	37989-M930-W3-00-__

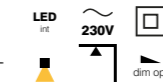

QS Q4 2020 black
QS Q4 2020 white

finishes

standard matt structure



all versions

Configure your product using the fold-out or our website.

LED integrated

power: dependent on version
CRI: CRI>90
CCT: 3000K | 4000K
beam angle:
53° —
SIRCA 14 LED recessed
59° —
SIRCA 10 LED recessed
dimming optional: DALI

RING 50

new



Captivating with its simplicity, the RING LED collection with an integrated light source corresponds perfectly with the 'less is more' trend. Thanks to the balanced form, RING 50 LED fixture is an interesting proposition for interiors in any style. Due to the small size, this luminaire is an ally of home spaces and smaller offices, where it will successfully highlight interesting decorations. Thanks to its parameters, RING 50 LED can also be used as a signpost in communication zones.

Urzekająca swą prostotą kolekcja RING LED ze zintegrowanym źródłem światła idealnie wpisuje się w trend „mniej znaczy więcej”. Dzięki wyważonej formie, oprawa RING 50 LED jest ciekawą propozycją dla wnętrz w każdym stylu. Ze względu na niewielkie gabaryty, ta oprawa to sprzymierzeniec przestrzeni domowych i mniejszych biur, gdzie z powodzeniem podkreśli ciekawe dekoracje. Dzięki swym parametrom RING 50 LED może posłużyć również jako świetlny drogowskaz w strefach komunikacyjnych.



standard type

RING next 50 LED recessed

aqform.com/R16813

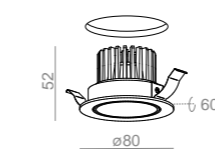

CRI>90 | 3000K | 36° | non dim

power	flux	cat. no
6.0W	800lm	37982-M930-F1-00-__



QS Q4 2020 black

QS Q4 2020 white

finishes

standard matt structure



additional



all versions

Configure your product using the fold-out or our website.

LED integrated

power: 6.0W
 CRI: CRI>90
 CCT: 3000K | 4000K
 beam angle: 36°
 dimming optional: DALI

RING 111



Modernity goes hand in hand with minimalism, as exemplified by the RING collection. Although modest, it can be expressive, while giving endless possibilities to our creativity. The combination of several luminaires creates an interesting composition, the solo version will serve as a single accent, while in a linear arrangement it will work as an effective lighting for leisure or communication zones. This family has a high colour rendering index and a convenient dimming option that will allow you to adjust the lighting intensity to your current needs. The QRLED version has won the German Design Award Special.

Nowoczesność idzie w parze z minimalizmem, czego świetnym przykładem jest kolekcja RING. Choć skromna, potrafi być wyrazista, dając przy tym nieskończone możliwości naszej kreatywności. Zestawienie kilku opraw tworzy ciekawą kompozycję, solo posłuży jako pojedynczy akcent, natomiast w układzie liniowym sprawdzi się jako efektywne oświetlenie stref wypoczynkowych czy komunikacyjnych. Rodzina ta posiada wysoki współczynnik odwzorowania barw oraz wygodną opcję ściemniania, która pozwoli dopasować natężenie oświetlenia do bieżących potrzeb. Wersja QRLED zdobyła nagrodę German Design Award Special.

standard type



RING 111 QRLED trimless recessed

aqform.com/R14063

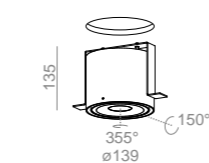

CRI>90 | 3000K | 38° | non dim

power	flux	cat. no
6.0W	880lm	30141-L930-F1-00-__
9.0W	1200lm	30141-M930-F1-00-__

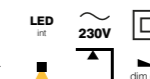

⌀141mm Hmin: 150mm



RING 111 QRLED recessed

aqform.com/R10063

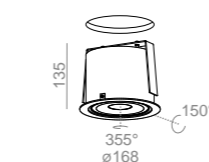

CRI>90 | 3000K | 38° | non dim

power	flux	cat. no
6.0W	880lm	30137-L930-F1-00-__
9.0W	1200lm	30137-M930-F1-00-__

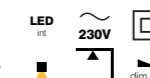

⌀145mm Hmin: 150mm

RING 111 trimless recessed

aqform.com/37161

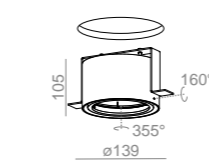

AR111, 12V | G53 | Phase-Control

power	cat. no
max: 35.0W, LED 15.0W	37161-0000-T8-PH-__

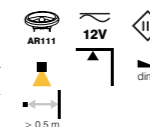

⌀141mm Hmin: 120mm

RING 111 recessed

aqform.com/37151

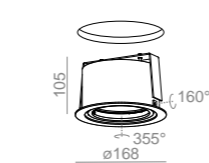

AR111, 12V | G53 | Phase-Control

power	cat. no
max: 35.0W, LED 15.0W	37151-0000-T8-PH-__

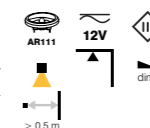

⌀145mm Hmin: 120mm

RING 111 trimless 230V recessed

aqform.com/37163

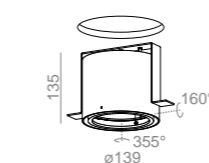

ES111, 230V | GU10 | Phase-Control

power	cat. no
max: 35.0W	37163-0000-U8-PH-__

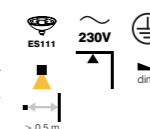

⌀141mm Hmin: 150mm

RING 111 230V recessed

aqform.com/37162

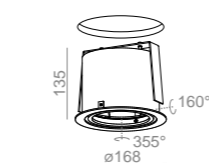

ES111, 230V | GU10 | Phase-Control

power	cat. no
max: 35.0W	37162-0000-U8-PH-__

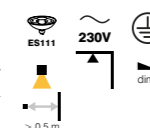

⌀145mm Hmin: 150mm

finishes

standard matt structure

QS from 01.2021



additional



additional gloss

for:

RING 111 trimless recessed

RING 111 recessed

RING 111 trimless 230V recessed

RING 111 230V recessed

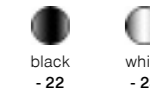

additional white-black

for:

RING 111 recessed



all versions

Configure your product using the fold-out or our website.

LED integrated

power: dependent on version
CRI: CRI>90
CCT: 2700 | 3000K | 4000K
beam angle: 38°
dimming optional: Phase-Control | DALI | switchDIM

AR111, 12V

power: max: 35.0W, LED 15.0W
dimming: Phase-Control
 light source not included
 additional gear required

ES111, 230V

power: max: 35.0W
dimming: Phase-Control
 light source not included



MORE

new



MORE luminaires attract the eye with a black chrome reflector, which, combined with the recessed light source, guarantees high visual comfort. Light hidden from sight is a procedure that protects user from glare. In addition, the reflector increases the precision of lighting, thanks to which MORE effectively emphasizes the details of home arrangements or aesthetically brightens the wall surface. Three diameters and different powers make MORE suitable for small home interiors 2.5m high as well as spacious offices, living rooms or communication spaces over 4m high.

Oprawy MORE przykuwają uwagę odbłyśnikiem wykończonym czarnym chromem, który w połączeniu z zagłębieniem źródła światła, gwarantuje wysoki komfort wizualny. Światło ukryte przed wzrokiem to zabieg chroniący oczy przed olśnieniem. Dodatkowo odbłyśnik podnosi precyzję świecenia, dzięki czemu MORE efektywnie podkreśli detale domowych aranżacji czy estetycznie rozświetli powierzchnię ściany. Trzy średnice i zróżnicowane moce sprawiają, że MORE sprawdzi się zarówno w niewielkich wnętrzach domowych o wysokości 2.5m, jak i w przestronnych biurach, salonach czy przestrzeniach komunikacyjnych o wysokości powyżej 4m.



standard type

MORE mini LED recessed

aqform.com/MR1013

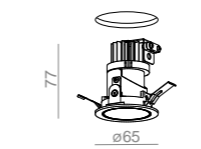

ø57mm Hmin: 80mm

CRI>90 | 3000K | 25° | non dim

power	flux	cat. no
6.0W	800lm	37983-M930-S1-00-13

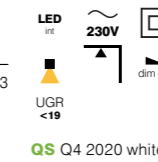

QS Q4 2020 white

MORE midi LED recessed

aqform.com/MR2013

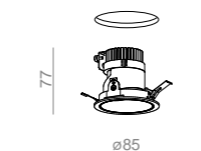

ø78mm Hmin: 82mm

CRI>90 | 3000K | 36° | non dim

power	flux	cat. no
9.0W	1120lm	37984-M930-F1-00-13

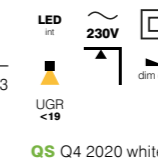

QS Q4 2020 white

MORE maxi LED recessed

aqform.com/MR3013

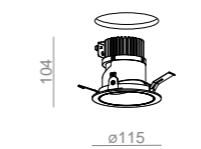

ø97mm Hmin: 105mm

CRI>90 | 3000K | 61° | non dim

power	flux	cat. no
12.0W	1570lm	37985-M930-W1-00-13

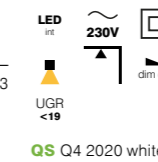

QS Q4 2020 white

finishes

standard matt structure



white
- 13

all versions

Configure your product using the fold-out or our website.

LED integrated

power: dependent on version

CRI: CRI>90

CCT: 3000K | 4000K

beam angle:

25° —

MORE mini LED recessed

36° —

MORE midi LED recessed

61° —

MORE maxi LED recessed

dimming optional: Phase-Control | DALI | switchDIM

SWING



True luxury enchanted in minimalism is emphasized in the SWING collection. Thanks to great parameters, it will easily highlight an important element of arrangement, show the way in the communication space and emphasize nature of the exhibition. The high CRI of the LED lamp enhances the attractiveness of colours, and thanks to the dimming option, it easily creates a nice atmosphere. Worth mentioning is the wide range of motion that allows you to better emphasize important details. SWING is also a subtle ornament that looks great both in a group and as a single accent.

Prawdziwy luksus zaklęty w minimalizmie podkreśla kolekcja SWING. Dzięki świetnym parametrom z łatwością wyeksponuje ważny element aranżacji, wskaże drogę w przestrzeni komunikacyjnej oraz podkreśli charakter ekspozycji. Wysoki współczynnik CRI lampy LED wzmacnia atrakcyjność kolorów, a dzięki opcji ściemniania, z łatwością stworzy nastrojową atmosferę. Warto również wspomnieć o szerokim zakresie ruchu, który pozwala na lepsze zaakcentowanie istotnych detali. SWING to także subtelna ozdoba świetnie prezentująca się w grupie oraz jako pojedynczy akcent.

standard type

SWING 12 LED trimless recessed

aqform.com/SW1013

CRI>90 3000K 38° non dim		LED int	230V	dim opt
power	flux	cat. no		
6.0W	880lm	36701-L930-F1-00-__		
9.0W	1200lm	36701-M930-F1-00-__		

ø100mm Hmin: 150mm

SWING 24 LED trimless recessed

aqform.com/SW2019

CRI>90 3000K 38° non dim		LED int	230V	dim opt
power	flux	cat. no		
6.0W	880lm	36704-L930-F1-00-__		
9.0W	1200lm	36704-M930-F1-00-__		

ø100mm Hmin: 150mm

SWING 12 trimless recessed

aqform.com/36700

PAR16, 230V GU10 Phase-Control		PAR16	230V	dim
power	cat. no			
max: 35.0W	36700-0000-U8-PH-__			

ø100mm Hmin: 150mm

SWING 24 trimless recessed

aqform.com/36703

PAR16, 230V GU10 Phase-Control		PAR16	230V	dim
power	cat. no			
max: 35.0W	36703-0000-U8-PH-__			

ø100mm Hmin: 150mm

finishes

standard matt structure



additional



all versions

Configure your product using the fold-out or our website.

LED integrated

power: dependent on version
CRI: CRI>90
CCT: 2700 | 3000K | 4000K
beam angle: 38°
dimming optional: DALI | switchDIM

PAR16, 230V

power: max: 35.0W
dimming: Phase-Control

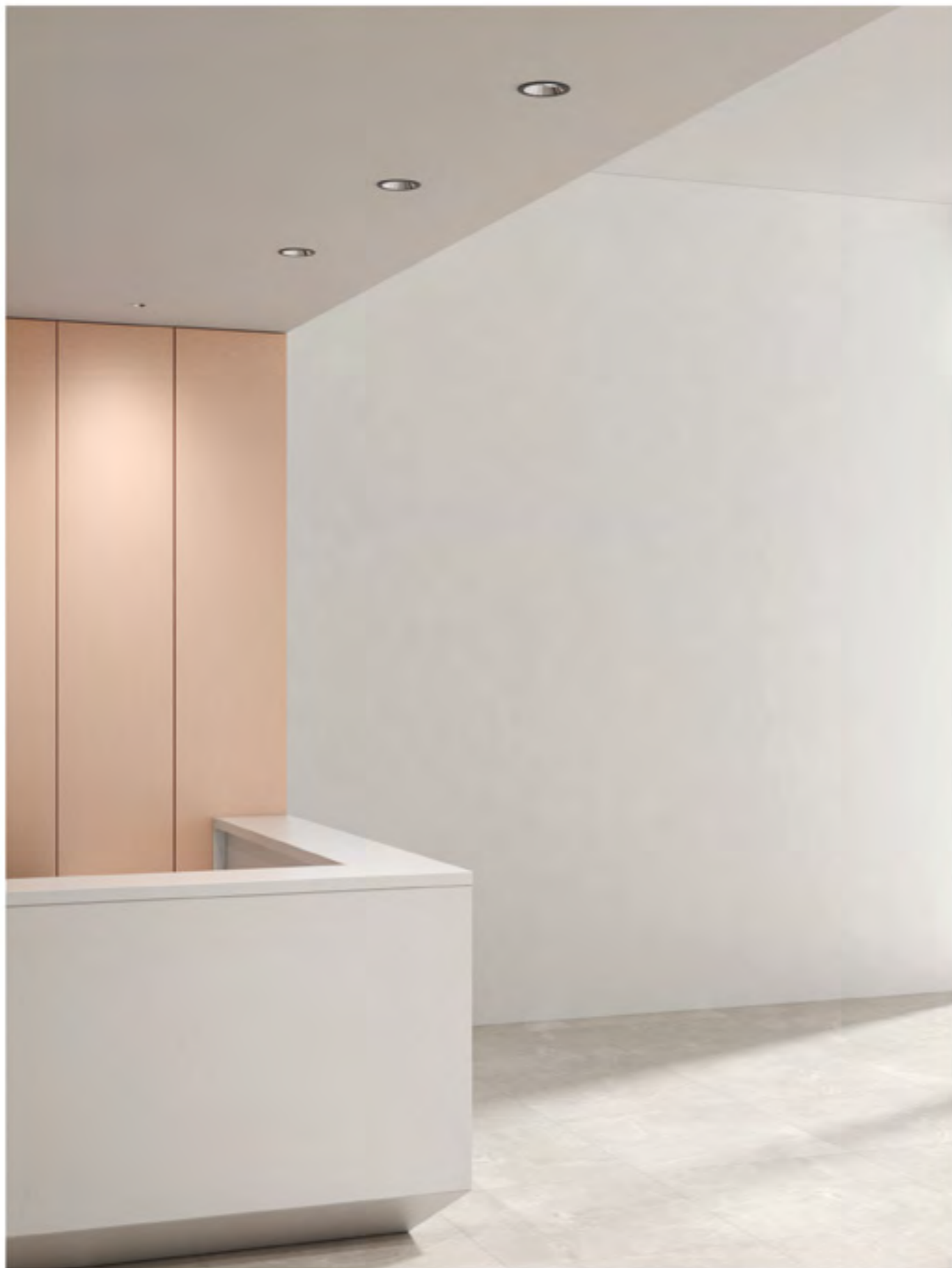

SQUARES next 50

new



Simplicity, functionality, economy of form – this is how the SQUARES next luminaire family can be described in brief. These products successfully highlight the unique accessories that complement modern arrangements, where there is no room for random decorations. Every detail should perfectly harmonize with the rest of the interior. SQUARES next composed in a line would show us the way in a dark corridor, while as individual luminaires they would work as accent lighting perfectly.

Prostota, funkcjonalność, oszczędność formy – tak w skrócie można opisać rodzinę opraw SQUARES next. Produkty te z powodzeniem podkreślą niepowtarzalne dodatki będące dopełnieniem nowoczesnych aranżacji, gdzie nie ma miejsca na przypadkowe ozdoby. Każdy detal powinien idealnie współgrać z resztą wnętrza. Skomponowane w linii SQUARES next wskażą nam drogę w ciemnym korytarzu, a jako pojedyncze oprawy znakomicie sprawdzą się jako oświetlenie akcentujące.



luminaire family

[p.132](#)

standard type

SQUARES next 50x1 LED trimless recessed

aqform.com/SX3813

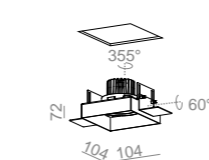

105x105mm Hmin: 85mm

CRI>90 | 3000K | 36° | non dim

power	flux	cat. no
6.0W	800lm	37990-M930-F1-00-__

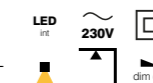

QS Q4 2020 black
QS Q4 2020 white

SQUARES next 50x1 LED recessed

aqform.com/SX1813

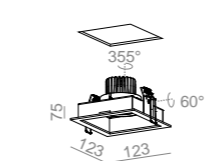

112x112mm Hmin: 85mm

CRI>90 | 3000K | 36° | non dim

power	flux	cat. no
6.0W	800lm	37979-M930-F1-00-__

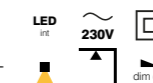

QS Q4 2020 black
QS Q4 2020 white

SQUARES next 50x2 LED trimless recessed

aqform.com/SX4813

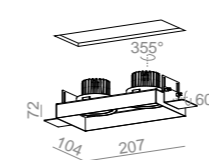

105x207mm Hmin: 85mm

CRI>90 | 3000K | 36° | non dim

power	flux	cat. no
12.0W	1610lm	37991-M930-F1-00-__

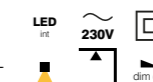

QS Q4 2020 black
QS Q4 2020 white

SQUARES next 50x2 LED recessed

aqform.com/SX2813

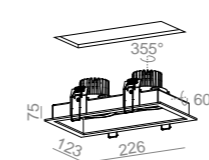

112x210mm Hmin: 85mm

CRI>90 | 3000K | 36° | non dim

power	flux	cat. no
12.0W	1610lm	37980-M930-F1-00-__

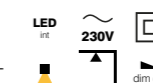

QS Q4 2020 black
QS Q4 2020 white

finishes

standard matt structure

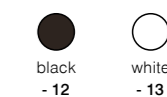

additional



all versions

Configure your product using the fold-out or our website.

LED integrated

power: dependent on version
CRI: CRI>90
CCT: 3000K | 4000K
beam angle: 36°
dimming optional: Phase-Control | DALI | switchDIM

SQUARES 50



Room lighting is one of the most important tasks in interior design process. The SQUARES 50 collection, thanks to its geometric shape, perfectly highlights both minimalist and more traditional interiors. The unified design will allow you to relax from the overflow of incentives. It will also allow you to display the colour of the entire fixture properly. SQUARES 50 in gold or copper finish can successfully become a strong point of the project. Individual luminaires work well as a light accent, while in groups they create general lighting.

Oświetlenie pomieszczenia to jedno z najważniejszych zadań w procesie aranżacji wnętrza. Kolekcja SQUARES 50, dzięki swym geometrycznym kształtom, świetnie podkreśla zarówno minimalistyczne, jak i bardziej tradycyjne wnętrza. Zunifikowany design pozwoli odpocząć od nadmiaru bodźców, umożliwi też na zagranie kolorem całej oprawy. SQUARES 50 w wykończeniu złotym czy miedzianym z powodzeniem może stać się mocnym punktem projektu. Pojedyncze oprawy dobrze sprawują się w roli akcentu świetlnego, z kolei w grupach pozwalają zrealizować oświetlenie ogólne.



luminaire family

— p.132

standard type

SQUARES 50x1 trimless 230V recessed

aqform.com/37011

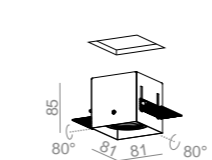

PAR16, 230V | GU10 | Phase-Control

power

max: 35.0W

cat. no

37011-0000-U8-PH-__

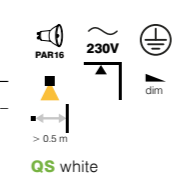

83x83mm Hmin: 95mm

SQUARES 50x1 230V recessed

aqform.com/36811

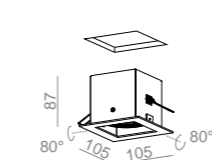

PAR16, 230V | GU10 | Phase-Control

power

max: 35.0W

cat. no

36811-0000-U8-PH-__

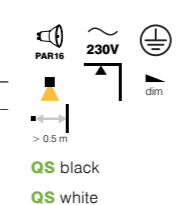

83x90mm Hmin: 95mm

SQUARES 50x2 230V recessed

aqform.com/36812

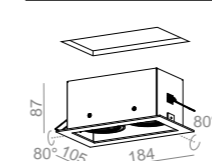

PAR16, 230V | GU10 | Phase-Control

power

max: 2x 35.0W

cat. no

36812-0000-U8-PH-__

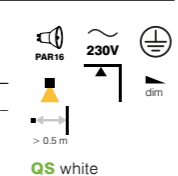

83x170mm Hmin: 95mm

SQUARES 50x2 trimless 230V recessed

aqform.com/37012

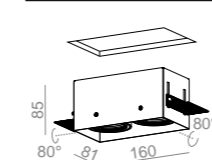

PAR16, 230V | GU10 | Phase-Control

power

max: 2x 35.0W

cat. no

37012-0000-U8-PH-__

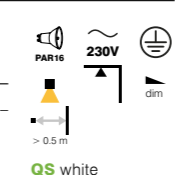

83x162mm Hmin: 95mm

finishes

standard matt structure

QS from 01.2021

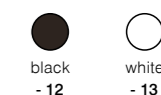

additional

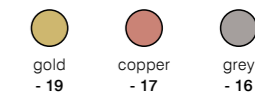

additional gloss

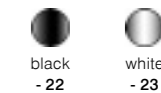

additional multicolour

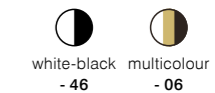

all versions

Configure your product using the fold-out or our website.

PAR16, 230V

power: dependent on version
dimming: Phase-Control
light source not included

mounting frame

available on webstie / dostępna na stronie

The mounting frame is an optional element for trimless recessed luminaires. It is recommended where there is a need for non-invasive disassembly of SQUARES type of luminaires. The frame facilitates the replacement of a transformer or a power supply.

Ramka montażowa jest opcjonalnym elementem dla opraw wpuszczanych trimless. Zalecana jest tam, gdzie zachodzi konieczność bezinwazyjnego demontażu opraw oświetleniowych typu SQUARES. Ułatwia wymianę transformatora lub zasilacza.

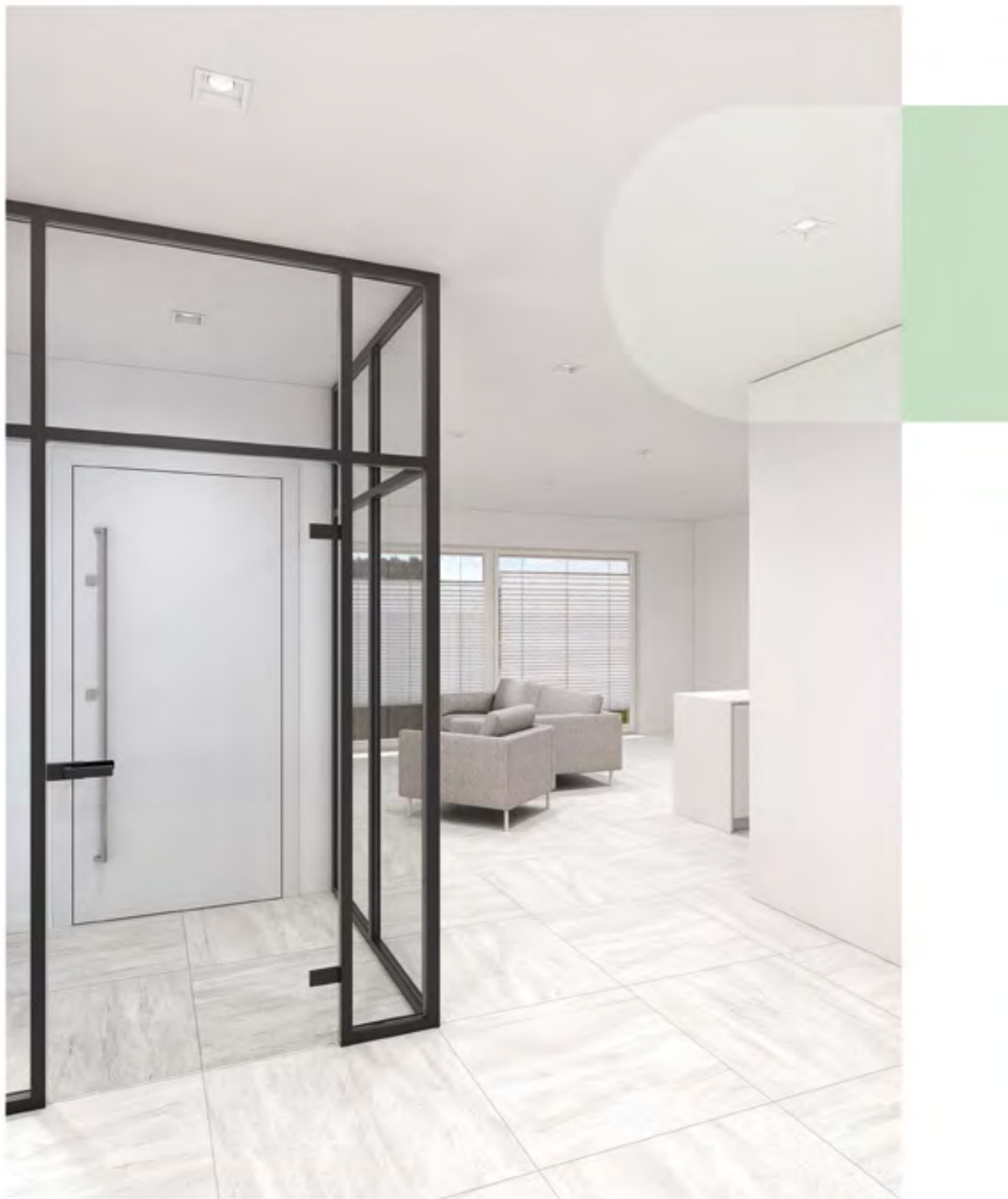

SQUARES 111 QRLED



function



luminaire family

[p.134](#)

Some arrangements require subtle lighting solution that will not be conspicuous, but thanks to good parameters it will play its role. Such is the family of SQUARES 111 QRLED fittings – not pushy yet effective. Their potential opens up a whole range of creative applications – from accenting important details to showing the direction with light. It depends only on us, how we decide to apply it – we have a lot of possibilities.

Niektóre aranżacje wymagają subtelnego oświetlenia, które nie będzie się rzucać w oczy, jednak dzięki dobrym parametrom celująco sprawdzi się w swej roli. Taka właśnie jest rodzina opraw SQUARES 111 QRLED – nienachalna, lecz skuteczna. Ogrom możliwości, które nam daje, otwiera cały wachlarz kreatywnych zastosowań – od akcentowania istotnych detali po wyznaczanie kierunku światłem. Tylko od nas zależy jak zdecydujemy się ją zastosować, opcji mamy naprawdę wiele.

standard type

SQUARES 111x1 QRLED trimless recessed

aqform.com/SQ4163

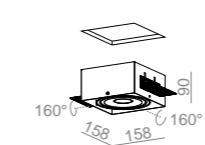

160x160mm Hmin: 100mm

CRI>90 | 3000K | 38° | non dim

power	flux	cat. no
6.0W	880lm	30108-L930-F1-00-__
9.0W	1200lm	30108-M930-F1-00-__



SQUARES 111x1 QRLED recessed

aqform.com/SQ0163

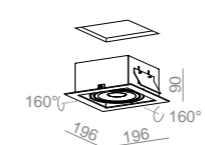

173x173mm Hmin: 100mm

CRI>90 | 3000K | 38° | non dim

power	flux	cat. no
6.0W	880lm	30104-L930-F1-00-__
9.0W	1200lm	30104-M930-F1-00-__

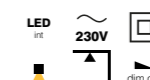

SQUARES 111x2 QRLED trimless recessed

aqform.com/SQ4263

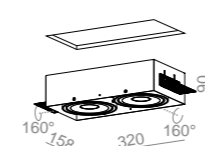

160x320mm Hmin: 100mm

CRI>90 | 3000K | 38° | non dim

power	flux	cat. no
12.5W	1770lm	30117-L930-F1-00-__
18.0W	2410lm	30117-M930-F1-00-__

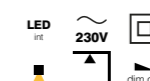

SQUARES 111x2 QRLED recessed

aqform.com/SQ0263

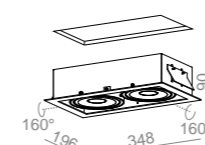

173x333mm Hmin: 100mm

CRI>90 | 3000K | 38° | non dim

power	flux	cat. no
12.5W	1770lm	30113-L930-F1-00-__
18.0W	2410lm	30113-M930-F1-00-__

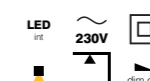

finishes

standard matt structure

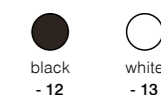

additional



all versions

Configure your product using the fold-out or our website.

LED integrated

power: dependent on version
CRI: CRI>90
CCT: 2700 | 3000K | 4000K
beam angle: 38°
dimming optional: Phase-Control | DALI | switchDIM

LED 230V integrated

SQUARES 111x1 QRLED 230V trimless recessed
aqform.com/SQ5163
 SQUARES 111x1 QRLED 230V recessed
aqform.com/SQ2163
 SQUARES 111x2 QRLED 230V trimless recessed
aqform.com/SQ5263
 SQUARES 111x2 QRLED 230V recessed
aqform.com/SQ2263

mounting frame

available on website / dostępna na stronie
 The mounting frame is an optional element for trimless recessed luminaires. It is recommended where there is a need for non-invasive disassembly of SQUARES type of luminaires. The frame facilitates the replacement of a transformer or a power supply.
 Ramka montażowa jest opcjonalnym elementem dla opraw wpuszczanych trimless. Zalecana jest tam, gdzie zachodzi konieczność bezinwazyjnego demontażu opraw oświetleniowych typu SQUARES. Ułatwia wymianę transformatora lub zasilacza.

SQUARES 111



In every space, it is worth taking care of properly selected lighting that will not dominate the arrangement, but instead emphasize its uniqueness. The SQUARES 111 product family is ideal for this role. It's a delicate accent, which highlights important details. The minimalist design makes SQUARES attractive for any type of arrangement.

W każdej przestrzeni warto zadbać o odpowiednio dobrane oświetlenie, które nie zdominuje aranżacji, lecz podkreśli jej wyjątkowość. Rodzina produktów SQUARES 111 idealnie sprawdza się w tej roli. Stanowi delikatny akcent podkreślający istotne detale. Minimalistyczne wzornictwo czyni oprawy SQUARES atrakcyjnymi dla każdego typu aranżacji.



luminaire family

[p.134](#)

standard type

SQUARES 111x1 trimless recessed

aqform.com/31811

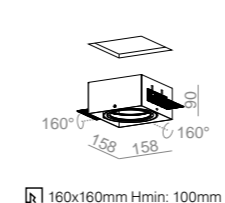

AR111, 12V | G53 | Phase-Control

power

max: 50.0W, LED 15.0W

cat. no

31811-0000-T8-PH-__

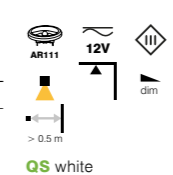

QS white

160x160mm Hmin: 100mm

SQUARES 111x1 recessed

aqform.com/30511

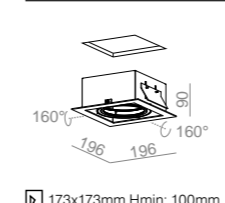

AR111, 12V | G53 | Phase-Control

power

max: 50.0W, LED 15.0W

cat. no

30511-0000-T8-PH-__

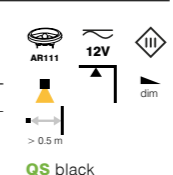

QS black

QS white

173x173mm Hmin: 100mm

SQUARES 111x2 trimless recessed

aqform.com/31912

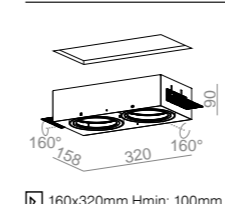

AR111, 12V | G53 | Phase-Control

power

max: 2x 50.0W, LED 15.0W

cat. no

31912-0000-T8-PH-__

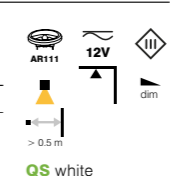

QS white

160x320mm Hmin: 100mm

SQUARES 111x2 recessed

aqform.com/30612

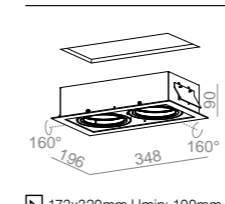

AR111, 12V | G53 | Phase-Control

power

max: 2x 50.0W, LED 15.0W

cat. no

30612-0000-T8-PH-__

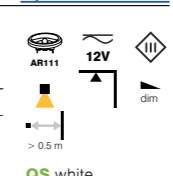

QS white

173x320mm Hmin: 100mm

finishes

standard matt structure

QS from 01.2021

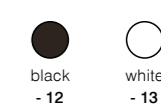

additional

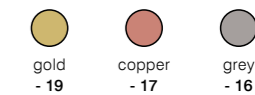

additional gloss



additional multicolour

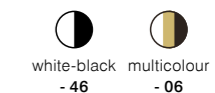

all versions

Configure your product using the fold-out or our website.

AR111, 12V

power: dependent on version
dimming: Phase-Control
light source not included
additional gear required

ES111, 230V

SQUARES 111x1 trimless 230V recessed
aqform.com/37511
SQUARES 111x1 230V recessed
aqform.com/35011
SQUARES 111x2 trimless 230V recessed
aqform.com/37512
SQUARES 111x2 230V recessed
aqform.com/35112

mounting frame

available on website / dostępna na stronie

The mounting frame is an optional element for trimless recessed luminaires. It is recommended where there is a need for non-invasive disassembly of SQUARES type of luminaires. The frame facilitates the replacement of a transformer or a power supply.

Ramka montażowa jest opcjonalnym elementem dla opraw wpuszczanych trimless. Zalecana jest tam, gdzie zachodzi konieczność bezinwazyjnego demontażu opraw oświetleniowych typu SQUARES. Ułatwia wymianę transformatora lub zasilacza.



MINISQUARE



The MINISQUARE family allows you to create an atmosphere tailored to the circumstances. Depending on whether we feel like having a movie afternoon with friends, a quiet evening with a book, or maybe a romantic dinner for two – each occasion requires a different light setting. Thanks to the convenient dimming function and deeply embedded light source, MINISQUARE is a universal solution whose soft light not only takes care of the mood or accentuates the stylish details of our home, but also serves as a signpost in the communication areas.

Rodzina MINISQUARE pozwala stworzyć atmosferę dopasowaną do okoliczności. Zależnie od tego, czy mamy akurat ochotę na filmowe popołudnie ze znajomymi, spokojny wieczór przy książce, a może romantyczną kolację we dwoje – każda okazja wymaga innej oprawy świetlnej. Dzięki wygodnej funkcji ściemniania oraz głęboko osadzonemu źródłu światła, MINISQUARE to uniwersalne rozwiązanie, którego delikatne światło nie tylko zadba o nastrojowy klimat czy zaakcentuje stylowe detale naszego domu, ale także posłuży jako drogowskaz w ciągu komunikacyjnym.



standard type

MINISQUARE x1 230V recessed

aqform.com/30019

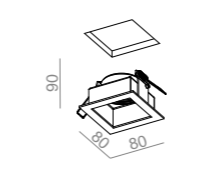

75x65mm Hmin: 90mm

PAR16, 230V | GU10 | Phase-Control

power

max: 35.0W

cat. no

30019-0000-U8-PH-__

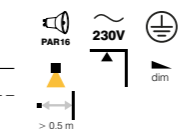

MINISQUARE x2 230V recessed

aqform.com/30018

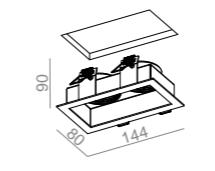

75x130mm Hmin: 90mm

PAR16, 230V | GU10 | Phase-Control

power

max: 2x 35.0W

cat. no

30018-0000-U8-PH-__

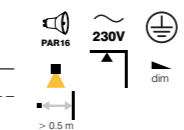

finishes

standard matt structure

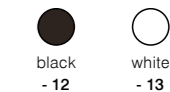

additional

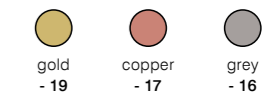

all versions

Configure your product using the fold-out or our website.

PAR16, 230V

power: max: 35.0W

dimming: Phase-Control

light source not included

SLEEK





The SLEEK collection is another option for accent lighting. The ease of directing the beam of light at a selected object allows you to shape the arrangement. Thanks to this, you can highlight the charm of your favorite painting or plant. SLEEK is available in a variant for one or two lighting points, in an integrated LED version or – for supporters of more conventional solutions – with a traditional light source. With the dimming option available, this luminaire will allow you to play with light, adapting it to your mood or time of day.

Kolekcja SLEEK to kolejny wariant oświetlenia akcentującego przestrzeń. Łatwość kierowania snopu światła na wybrany obiekt pozwala modelować aranżację. Dzięki temu można podkreślić urok ulubionego obrazu czy rośliny. SLEEK dostępny jest w wariacie na jeden lub dwa punkty świetlne, w wersji zintegrowanej LED lub – dla zwolenników bardziej tradycyjnych rozwiązań – z wymiennym źródłem światła. Dzięki dostępnej opcji ściemniania, oprawa ta pozwoli na zabawę światłem, dostosowując się do naszego nastroju bądź pory dnia.



luminaire family

-  [p.138](#)
-  [p.324](#)

standard type



SLEEK 11x1 QRLED recessed

aqform.com/SL3063

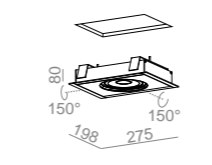

175x255mm Hmin: 90mm

CRI>90 | 3000K | 38° | non dim

power	flux	cat. no
6.0W	880lm	30145-L930-F1-00-__
9.0W	1200lm	30145-M930-F1-00-__

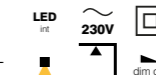

SLEEK 11x2 QRLED recessed

aqform.com/SL4063

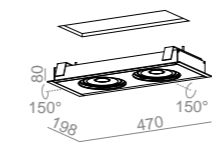

175x450mm Hmin: 90mm

CRI>90 | 3000K | 38° | non dim

power	flux	cat. no
12.5W	1770lm	30147-L930-F1-00-__
18.0W	2410lm	30147-M930-F1-00-__

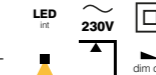

SLEEK 11x1 recessed

aqform.com/30023

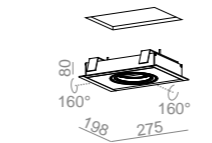

175x255mm Hmin: 90mm

AR111, 12V | G53 | Phase-Control

power	cat. no
max: 50.0W, LED 15.0W	30023-0000-T8-PH-__

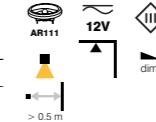

SLEEK 11x2 recessed

aqform.com/30024

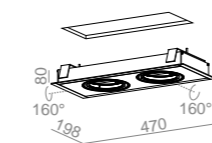

175x450mm Hmin: 90mm

AR111, 12V | G53 | Phase-Control

power	cat. no
max: 2x 50.0W, LED 15.0W	30024-0000-T8-PH-__

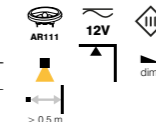

finishes

standard matt structure



additional



additional gloss

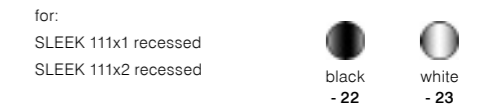

additional white-black



all versions

Configure your product using the fold-out or our website.

LED integrated

power: dependent on version
CRI: CRI>90
CCT: 2700 | 3000K | 4000K
beam angle: 38°
dimming optional: Phase-Control | DALI | switchDIM

AR111, 12V

power: dependent on version
dimming: Phase-Control
 light source not included
 additional gear required



CIRCLES OF LIGHT



When looking for decorative luminaires that can be used as general lighting, it is worth noticing solutions that light up the entire surface. Luminaires with an integrated LED light source and high CRI with an opal diffuser would be ideal for this role. These products will help us multiply the effect of stylish simplicity and will work also in large interiors (a single MAXI RING or four RING fixtures will easily cope with the lighting of a 16m² room). Their neutral design will add a taste to any modern arrangement, intriguing with its form.

Szukając opraw o charakterze dekoracyjnym, które mogą posłużyć jako oświetlenie ogólne, warto zwrócić uwagę na rozwiązania świecące całą powierzchnią. Oprawy o zintegrowanym źródle światła LED i wysokim współczynniku CRI wraz z przestroną rozpraszającą światło będą idealne do tej roli. Produkty te pomogą zwielokrotnić efekt stylowej prostoty i sprawdzą się nawet w dużych wnętrzach (pojedynczy MAXI RING lub cztery oprawy RING bez problemu poradzą sobie z oświetleniem pomieszczenia o powierzchni 16m²). Ich neutralne wzornictwo doda smaku każdej nowoczesnej aranżacji, zaciekawiając formą.



function

luminaire family

 [p.126](#)

 [p.184](#)

standard type

RING LED recessed

aqform.com/RG0013

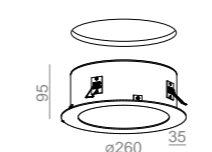

CRI>80 | 3000K | non dim

power	flux	cat. no
12.0W	1920lm	37921-L830-D9-00-__
16.0W	2560lm	37921-M830-D9-00-__

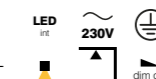

⌀ 230mm Hmin: 110mm

AQsmart REVEL LED recessed

aqform.com/RE0013

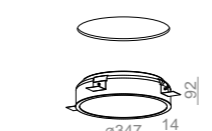

CRI>90 | 3000K | non dim

power	flux	cat. no
8.5W	1270lm	30234-L930-D9-00-__
17.0W	2550lm	30234-M930-D9-00-__

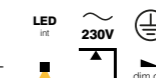

⌀ 335mm Hmin: 105mm

AQsmart MAXI RING LED recessed

aqform.com/MR0013

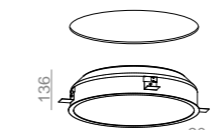

CRI>90 | 3000K | non dim

power	flux	cat. no
14.5W	2230lm	37950-L930-D9-00-__
30.0W	4460lm	37950-M930-D9-00-__

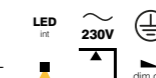

⌀ 505mm Hmin: 145mm

finishes

standard matt structure



additional

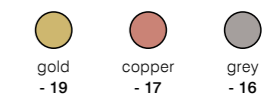

additional gloss

for:

RING LED recessed

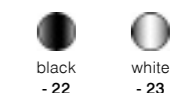

all versions

Configure your product using the fold-out or our website.

LED integrated

power: dependent on version

CRI: dependent on version

CCT:

3000K | 4000K —

RING LED recessed

REVEL LED recessed

3000K | 4000K | 2700-6500K —

MAXI RING LED recessed

dimming optional:

Phase-Control | DALI | switchDIM —

RING LED recessed

DALI | switchDIM | AQsmart —

REVEL LED recessed

MAXI RING LED recessed

BIG SIZE round





BIG SIZE round creates an extremely effective family of integrated LED luminaires. Several sizes, the ability to adjust the power and the flux, as well as high CRI make these luminaires great for both commercial and private spaces. BIG SIZE round is also a recommended solution for offices due to the possibility of using a microprismatic cover. Products from this line successfully brighten larger spaces, while guaranteeing high levels of horizontal lighting and highlight of the walls.

BIG SIZE round tworzy wyjątkowo skuteczną rodzinę zintegrowanych opraw LED. Kilka rozmiarów, możliwość dostosowania mocy, a co za tym idzie również strumienia świetlnego oraz wysoki współczynnik CRI sprawiają, iż oprawy te świetnie sprawdzą się zarówno w przestrzeniach komercyjnych, jak i prywatnych. Dzięki możliwości zastosowania przeszłony mikropryzmatycznej, BIG SIZE round to także znakomite rozwiązanie dla biur. Produkty z tej linii z powodzeniem oświetlą większe przestrzenie, gwarantując jednocześnie duże natężenie oświetlenia na płaszczyznach poziomych oraz doświetlone ściany.

function 

luminaire family

 [p.142](#)

 [p.200](#)

standard type

AQsmart

BIG SIZE next round LED recessed

aqform.com/BS1113

CRI>90 | 3000K | non dim

diameter	power (min – max)	flux (min – max)	cat. no
670mm	21.5 – 38.5W	3310 – 5790lm	30152-A930-D9-00-__
970mm	39.5 – 71.0W	6120 – 10700lm	30153-A930-D9-00-__
1240mm	72.5 – 130.0W	11220 – 19620lm	30154-A930-D9-00-__

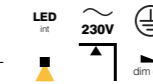

AQsmart

BIG SIZE PRO next round LED recessed

aqform.com/BS1113

CRI>90 | 3000K | non dim

diameter	power (min – max)	flux (min – max)	cat. no
670mm	21.5 – 38.5W	3310 – 5790lm	37993-A930-D5-00-__
970mm	39.5 – 71.0W	6120 – 10700lm	37994-A930-D5-00-__
1240mm	72.5 – 130.0W	11220 – 19620lm	37992-A930-D5-00-__

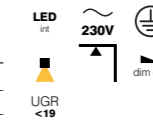

covers comparison



regular (opal)



PRO (microprism)

See PRO lighting effect on the website

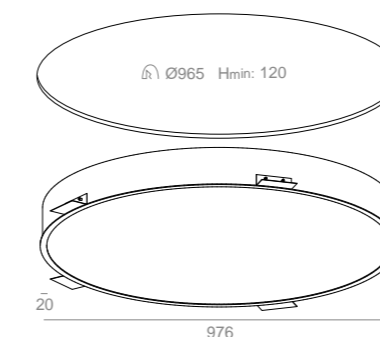
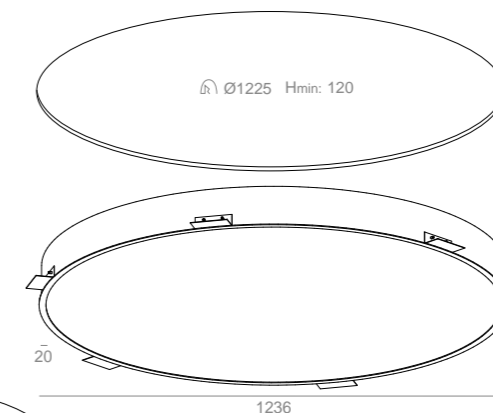
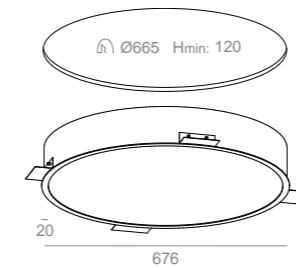

finishes

standard matt structure



additional



all versions

Configure your product using the fold-out or our website.

LED integrated

power:

ø660mm — 21.5-38.5W¹ | 70.0W²
 ø960mm — 39.5-71.0W¹ | 150.0W²
 ø1220mm — 72.5-130.0W¹ | 250.0W²

CRI: CRI>90

CCT: 3000K | 4000K | 2700-6500K

dimming optional: DALI | switchDIM | AQsmart

¹ adjustable power is available for CCT 3000K and 4000K

² Tunable-White (2700-6500K) has power always set for M and needs DALI or AQsmart control

BIG SIZE square





For fans of more angular solutions, we present the BIG SIZE square line, which in its new version has an increased luminous efficacy. Excellent parameters, typical for this family, easily light up communication spaces, offices and all kinds of large interiors. From an aesthetic point of view, the lack of glamour yet a classic simplicity make the BIG SIZE collection a tasteful arrangement decoration. Available control systems, colour temperature regulation and the possibility of choosing optics make this family extremely versatile.

Dla sympatyków kątów prostych przedstawiamy linię BIG SIZE square, która w nowej odsłonie może pochwalić się wzrostem skuteczności świetlnej. Znakomite parametry, typowe dla tej rodziny, bez problemu oświetlą z dużym natężeniem przestrzenie komunikacyjne, biura oraz wszelkiego rodzaju duże wnętrza. Z estetycznego punktu widzenia, brak przepychu oraz klasyczna prostota czynią kolekcję BIG SIZE gustowną ozdobą aranżacji. Dostępne systemy sterowania, regulacji temperatury barwowej i możliwość wyboru optyki sprawiają, że ta rodzina jest niezwykle uniwersalna.



luminaire family

 [p.144](#)

 [p.202](#)

standard type

AQsmart

BIG SIZE next square LED recessed

aqform.com/BS1213

CRI>90 | 3000K | non dim

size	power (min – max)	flux (min – max)	cat. no
316x616mm	13.0 – 23.5W	2040 – 3560lm	30164-A930-D9-00-__
316x916mm	20.0 – 35.5W	3060 – 5350lm	30165-A930-D9-00-__
316x1216mm	26.5 – 47.0W	4080 – 7130lm	30166-A930-D9-00-__
616x616mm	26.5 – 47.0W	4080 – 7130lm	30167-A930-D9-00-__
616x916mm	39.5 – 71.0W	6120 – 10700lm	30168-A930-D9-00-__
616x1216mm	53.0 – 94.5W	8160 – 14270lm	30169-A930-D9-00-__
916x916mm	59.5 – 106.0W	9180 – 16050lm	30170-A930-D9-00-__
916x1216mm	69.5 – 124.0W	10710 – 18730lm	30171-A930-D9-00-__
1216x1216mm	92.5 – 165.0W	14280 – 24970lm	30172-A930-D9-00-__



AQsmart

BIG SIZE PRO next square LED recessed

aqform.com/BS1213

CRI>90 | 3000K | non dim

size	power (min – max)	flux (min – max)	cat. no
316x616mm	13.0 – 23.5W	2040 – 3560lm	37999-A930-D5-00-__
316x916mm	20.0 – 35.5W	3060 – 5350lm	38000-A930-D5-00-__
316x1216mm	26.5 – 47.0W	4080 – 7130lm	38001-A930-D5-00-__
616x616mm	26.5 – 47.0W	4080 – 7130lm	38002-A930-D5-00-__
616x916mm	39.5 – 71.0W	6120 – 10700lm	38003-A930-D5-00-__
616x1216mm	53.0 – 94.5W	8160 – 14270lm	37995-A930-D5-00-__
916x916mm	59.5 – 106.0W	9180 – 16050lm	37996-A930-D5-00-__
916x1216mm	69.5 – 124.0W	10710 – 18730lm	37997-A930-D5-00-__
1216x1216mm	92.5 – 165.0W	14280 – 24970lm	37998-A930-D5-00-__



covers comparison



regular (opal)



PRO (microprism)

See PRO lighting effect on the website

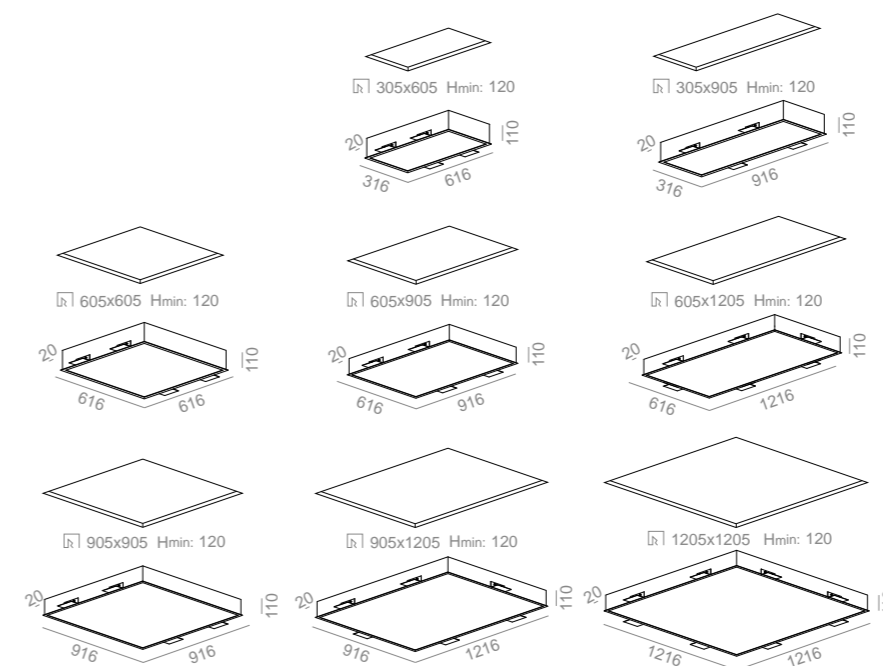

finishes

standard matt structure



additional



all versions

Configure your product using the fold-out or our website.

LED integrated

power:

- 300x600mm — 13.0-23.5W¹ | 40.0W²
- 300x900mm — 20.0-35.5W¹ | 60.0W²
- 300x1200mm — 26.5-47.0W¹ | 80.0W²
- 600x600mm — 26.5-47.0W¹ | 80.0W²
- 600x900mm — 39.5-71.0W¹ | 120.0W²
- 600x1200mm — 53.0-94.5W¹ | 160.0W²
- 900x900mm — 59.5-106.0W¹ | 180.0W²
- 900x1200mm — 69.5-124.0W¹ | 240.0W²
- 1200x1200mm — 92.5-165.0W¹ | 320.0W²

CRI: CRI>90

CCT: 3000K | 4000K | 2700-6500K

dimming optional: DALI | switchDIM | AQsmart

¹ adjustable power is available for CCT 3000K and 4000K
² Tunable-White (2700-6500K) has power always set for M and needs DALI or AQsmart dimming

LENS LINE / MIXLINE





In modern interiors, simplicity and convenience rule. It inspired us to create the LENS LINE and MIXLINE collections, which are an accurate combination of general and task lighting. The simple, linear form is perfect for brightening long, flat or rectangular surfaces. This means that these luminaires will be equally effective in galleries, museums, offices and communication areas, as in the home living room. Thanks to the improved optics, this family reduces glare effect while maintaining high efficiency.

W nowoczesnych wnętrzach rządzi prostota i wygoda. Było to dla nas inspiracją do stworzenia kolekcji LENS LINE oraz MIXLINE, stanowiących trafne połączenie oświetlenia ogólnego oraz zadaniowego. Prosta, liniowa forma doskonale sprawdzi się przy iluminacji długich, płaskich lub prostokątnych powierzchni. Oznacza to, że oprawy te równie skutecznie zaświecą w galeriach, muzeach, biurach i przestrzeniach komunikacyjnych co w domowym salonie. Dzięki udoskonalonej optyce, rodzina ta może się pochwalić zredukowanym efektem oślnienia przy zachowaniu dużej wydajności.



luminaire family

-  [p.148 / 150](#)
-  [p.208 / 210](#)
-  [p.402](#)

standard type

LENS LINE 43 LED recessed

aqform.com/LL0013

CRI>90 3000K 54° non dim				LED int	230V	UGR <19
power	flux	cat. no				
3.5W	400lm	30173-L930-W3-00-__				
7.5W	760lm	30173-M930-W3-00-__				

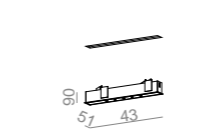

46x424mm Hmin: 110mm

AQsmart LENS LINE LED section recessed

aqform.com/LL0613

CRI>90 3000K 54° non dim				LED int	230V	UGR <19	dim opt
length	power	flux	cat. no				
960mm	14.5W	1530lm	30175-M930-W3-00-__				
1490mm	22.0W	2290lm	30177-M930-W3-00-__				
2020mm	29.0W	3060lm	30179-M930-W3-00-__				

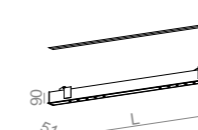

46mm Hmin: 110mm

AQsmart LENS LINE 180x89 RC LED recessed

aqform.com/LL3013

CRI>90 3000K 54° non dim				LED int	230V	UGR <19	dim opt
power	flux	cat. no					
14.0W	1630lm	30230-L930-W3-00-__					
29.0W	3060lm	30230-M930-W3-00-__					

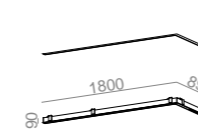

Hmin: 110mm

AQsmart MIXLINE LED recessed

aqform.com/MX0013

CRI>90 3000K 54° non dim				LED int	230V	UGR <19	dim opt
length	power	flux	cat. no				
1600mm	15.5W	2030lm	30225-M930-W3-00-__				
1880mm	24.5W	3240lm	30226-M930-W3-00-__				
2160mm	33.0W	4460lm	30227-M930-W3-00-__				

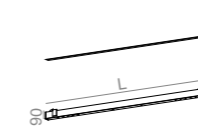

46mm Hmin: 110mm

AQsmart MIXLINE INV LED recessed

aqform.com/MX1013

CRI>90 3000K 54° non dim				LED int	230V	UGR <19	dim opt
length	power	flux	cat. no				
1670mm	21.0W	2830lm	30228-M930-W3-00-__				
1920mm	24.5W	3240lm	30229-M930-W3-00-__				

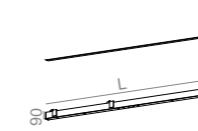

46mm Hmin: 110mm

how covers and lenses are placed

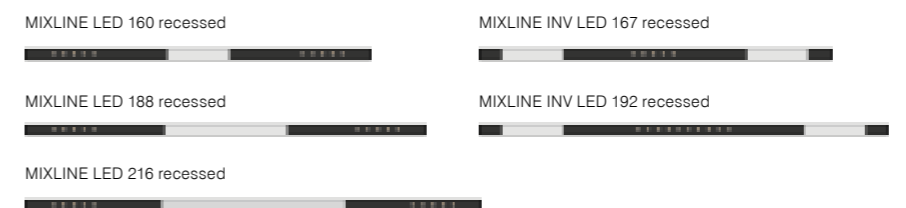

finishes

standard matt structure



additional

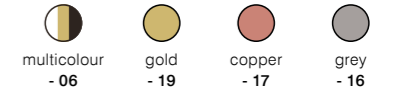

all versions

Configure your product using the fold-out or our website.

LED integrated

- power:**
- LENS LINE LED section recessed
 - 960mm — 7.0W | 14.5W
 - 1490mm — 10.5W | 22.0W
 - 2020mm — 14.0W | 29.0W
- CRI:** CRI>90
- CCT:** 2700 | 3000K | 4000K
- beam angle:** 26° | 54°
- dimming optional:**
- DALI | switchDIM | AQsmart —
 - LENS LINE LED section recessed
 - LENS LINE 180x89 RC LED recessed
 - MIXLINE LED recessed
 - MIXLINE INV LED recessed



private apartment, Poznań | design: LOFFT ARCHITEKTURA Małgorzata Hendrych-Lubińska

SET RAW mini

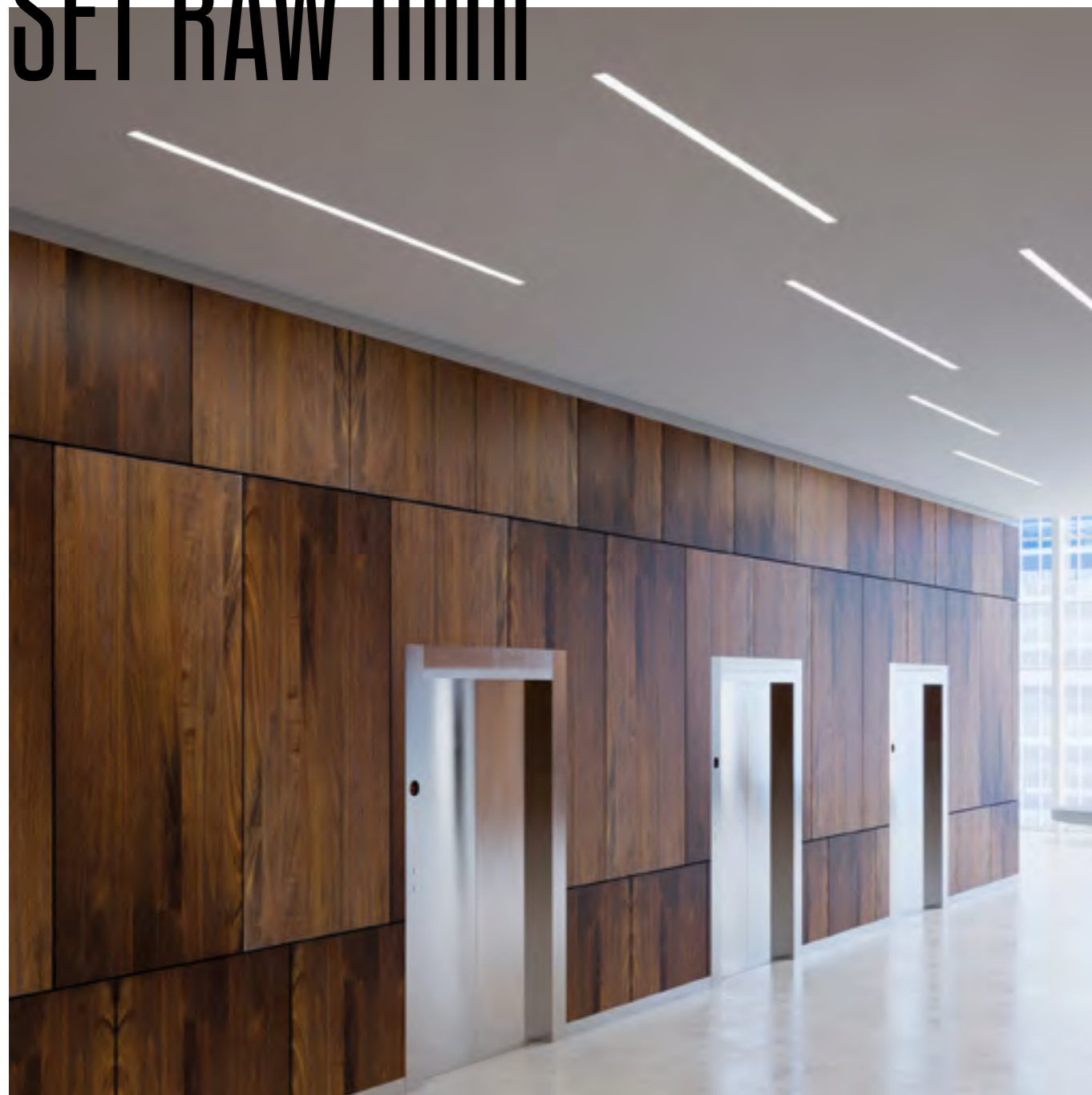



Minimalist luminaires please the eye with their simplicity, while their sharp lines emphasize the modern style of interior, giving it visual spaciousness. The inconspicuous family of SET RAW mini luminaires surprises with its power, successfully brightening large spaces, as well as entrances and communication zones in homes, offices or hotels. This neat linear lighting combines classic design with good parameters, emitting pleasant, diffused light of the highest quality.

Minimalistyczne oprawy zachwycają swą prostotą, a ostre linie podkreślają nowoczesny styl wnętrza, dodając mu wizualnej przestronności. Niepozornie wyglądająca rodzina opraw SET RAW mini zaskakuje swoją mocą, z powodzeniem oświetlając duże przestrzenie, a także strefy wejściowe i komunikacyjne w domu, biurze czy hotelu. To zgrabne oświetlenie liniowe łączy w sobie klasyczny design z dobrymi parametrami, emitując przyjemne, rozproszone światło najwyższej jakości.

function



luminaire family

-  [p.156](#)
-  [p.214](#)
-  [p.302](#)

-  [p.376](#)
-  [p.414](#)

standard type

AQsmart

SET RAW mini LED recessed

aqform.com/SR1013

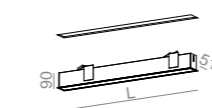

46mm Hmin: 110mm

CRI>90 | 3000K | non dim

length	power	flux	cat. no
580mm	9.0W	1210lm	30383-L930-D9-00-__
720mm	11.0W	1520lm	30256-L930-D9-00-__
870mm	13.0W	1820lm	30385-L930-D9-00-__
1010mm	15.5W	2120lm	30257-L930-D9-00-__
1150mm	17.5W	2430lm	30387-L930-D9-00-__
1430mm	22.0W	3040lm	30389-L930-D9-00-__
1710mm	26.5W	3640lm	30391-L930-D9-00-__
1990mm	31.0W	4250lm	30393-L930-D9-00-__

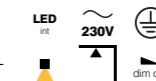

finishes

standard matt structure



additional



additional gloss

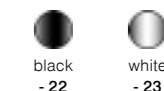

all versions

Configure your product using the fold-out or our website.

LED integrated

power:

580mm — 9.0W | 17.5W
 720mm — 11.0W | 22.0W
 870mm — 13.0W | 26.0W
 1010mm — 15.5W | 30.5W
 1150mm — 17.5W | 35.0W
 1430mm — 22.0W | 43.5W
 1710mm — 26.5W | 52.0W
 1990mm — 31.0W | 61.0W

CRI: CRI>90

CCT: 2700 | 3000K | 4000K

dimming optional:

DALI | switchDIM | AQsmart —
 from length 870mm

RAFTER points trim

new



RAFTER trim is another suggestion for luminaires with a wide spectrum of applications. Small dimensions are an invitation to create compositions using several or even several dozen of these fixtures at the same time. Despite its inconspicuous form, RAFTER trim has parameters that allow you to effectively brighten office, home or communication zones, while guaranteeing high efficiency and visual comfort. RAFTER trim is also an effective accent lighting solution. The geometric form and raw design make the RAFTER collection attractive for any space where modernity goes hand in hand with minimalism.

RAFTER trim to kolejna propozycja opraw o szerokim spektrum zastosowań. Niewielkie gabaryty są zaproszeniem do tworzenia kompozycji z wykorzystaniem kilku, a nawet kilkudziesięciu opraw równocześnie. Mimo swej niepozornej formy, RAFTER trim posiada parametry, które pozwalają skutecznie oświetlić strefy komunikacyjne, biurowe czy domowe, gwarantując przy tym dużą skuteczność świetlną i komfort wizualny. RAFTER trim to także efektywne oświetlenie akcentujące. Geometryczna forma oraz surowy design czynią kolekcję RAFTER atrakcyjną dla każdej przestrzeni, gdzie nowoczesność idzie w parze z minimalizmem.



standard type

RAFTER points 5 LED trim recessed

aqform.com/RA2013

CRI>90 | 3000K | 50° | non dim

power	flux	cat. no
1.0W	120lm	37970-L930-W1-00-__
2.0W	210lm	37970-M930-W1-00-__

LED int 230V UGR <13

QS Q4 2020 black
QS Q4 2020 white

35x35mm Hmin: 70mm

RAFTER points 8 LED trim recessed

aqform.com/RA2013

CRI>90 | 3000K | 50° | non dim

power	flux	cat. no
2.0W	240lm	37972-L930-W1-00-__
4.0W	430lm	37972-M930-W1-00-__

LED int 230V UGR <13

QS Q4 2020 black
QS Q4 2020 white

35x65mm Hmin: 70mm

RAFTER points 15 LED trim recessed

aqform.com/RA2013

CRI>90 | 3000K | 50° | non dim

power	flux	cat. no
5.0W	610lm	37973-L930-W1-00-__
10.5W	1080lm	37973-M930-W1-00-__

LED int 230V UGR <13
dim opt

QS Q4 2020 black
QS Q4 2020 white

35x138mm Hmin: 70mm

RAFTER points 28 LED trim recessed

aqform.com/RA2013

CRI>90 | 3000K | 50° | non dim

power	flux	cat. no
10.0W	1230lm	37974-L930-W1-00-__
20.5W	2170lm	37974-M930-W1-00-__

LED int 230V UGR <13
dim opt

QS Q4 2020 black
QS Q4 2020 white

35x271mm Hmin: 70mm

RAFTER points 41 LED trim recessed

aqform.com/RA2013

CRI>90 | 3000K | 50° | non dim

power	flux	cat. no
15.0W	1850lm	37975-L930-W1-00-__
31.0W	3250lm	37975-M930-W1-00-__

LED int 230V UGR <13
dim opt

QS Q4 2020 black
QS Q4 2020 white

35x403mm Hmin: 70mm

finishes

standard matt structure



additional



all versions

Configure your product using the fold-out or our website.

LED integrated

power: dependent on version

CRI: CRI>90

CCT: 2700 | 3000K | 4000K

beam angle: 37° | 50°

dimming optional:

DALI —

RAFTER points 15 LED trim recessed

RAFTER points 28 LED trim recessed

RAFTER points 41 LED trim recessed

RAFTER wall washer trim

new



function



RAFTER wall washer is recommended for accent lighting, which, thanks to its technical parameters, will be great above all as lighting for wallpapers, paintings and other vertical decorations. Thanks to the use of asymmetrical optics, the walls are highlighted evenly. This effect allows you to emphasize the vertical elements of the interior even better. Minimalist design is definitely an advantage of the RAFTER line, thanks to which it fulfills its tasks not just perfectly, but also discreetly.

RAFTER wall washer to propozycja oświetlenia akcentującego, które dzięki swym parametrom technicznym świetnie sprawdzi się przede wszystkim jako oświetlenie fototapet, obrazów i innych pionowych dekoracji. Dzięki zastosowaniu asymetrycznej optyki, ściany oświetlone są równomiernie. Taki efekt pozwala jeszcze lepiej podkreślić wertykalne elementy wystroju wnętrza. Minimalistyczne wzornictwo to zdecydowanie mocny punkt linii RAFTER, dzięki czemu nie tylko spełnia swoje zadania celująco, ale i dyskretnie.

standard type

RAFTER wall washer 15 LED trim recessed

aqform.com/RA2213

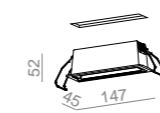

35x138mm Hmin: 70mm

CRI>90 | 3000K | non dim

power	flux	cat. no
5.0W	560lm	37976-L930-R1-00-__

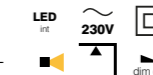

RAFTER wall washer 28 LED trim recessed

aqform.com/RA2213

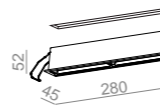

35x271mm Hmin: 70mm

CRI>90 | 3000K | non dim

power	flux	cat. no
10.0W	1130lm	37977-L930-R1-00-__

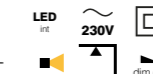

RAFTER wall washer 41 LED trim recessed

aqform.com/RA2213

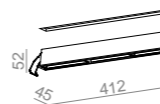

35x403mm Hmin: 70mm

CRI>90 | 3000K | non dim

power	flux	cat. no
15.0W	1700lm	37978-L930-R1-00-__

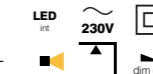

finishes

standard matt structure



additional



all versions

Configure your product using the fold-out or our website.

LED integrated

power: dependent on version

CRI: CRI>90

CCT: 2700 | 3000K | 4000K

dimming optional: DALI

RAFTER mix

new



Consistency and harmony characterize stylish interiors. In the case of lighting, it's good if they possess proper technical parameters. The RAFTER mix family combines all these outlines, and its multitasking skills surprise. This comfortable and universal lighting is dedicated to large spaces, communication zones, but also creates a nice atmosphere when we want to watch a movie with friends or relax with a favourite book. By combining several types of optics in one product, RAFTER allows for a wide range of creativity.

Spójność i harmonia cechują stylowe wnętrza. W przypadku oświetlenia dobrze, jeśli idą w parze z właściwymi parametrami technicznymi. Rodzina RAFTER mix łączy w sobie te wszystkie wytyczne, a jej wielozadaniowość zaskakuje. To wygodne i wszechstronne oświetlenie dedykowane jest dużym przestrzeniom, strefom komunikacyjnym, ale także stworzy nastrojowy klimat, kiedy chcemy obejrzeć film z przyjaciółmi lub zrelaksować się przy ulubionej książce. Dzięki połączeniu kilku rodzajów optyki w jednym produkcie, RAFTER daje szerokie pole do popisu naszej kreatywności.



luminaire family

[p.160](#)

standard type

RAFTER mix 57 LED recessed

aqform.com/RA9013

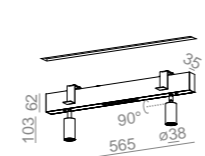

CRI>90 | 3000K | 50° | non dim

power	flux	cat. no
11.0W	1390lm	37953-M930-W1-00-__

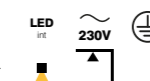

37x569mm Hmin: 90mm

RAFTER mix 94 LED recessed

aqform.com/RA9013

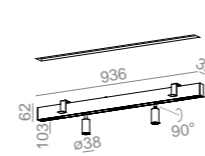

CRI>90 | 3000K | 50° | non dim

power	flux	cat. no
21.0W	2620lm	37954-M930-W1-00-__

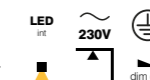

37x939mm Hmin: 90mm

RAFTER mix 133 LED recessed

aqform.com/RA9013

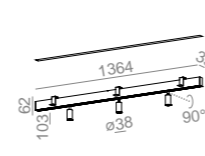

CRI>90 | 3000K | 50° | non dim

power	flux	cat. no
29.0W	3630lm	37955-M930-W1-00-__

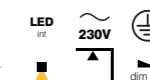

37x1339mm Hmin: 90mm

RAFTER mix 136 LED recessed

aqform.com/RA9013

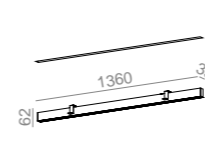

CRI>90 | 3000K | 50° | non dim

power	flux	cat. no
32.5W	4090lm	37956-M930-W1-00-__

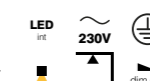

37x1367mm Hmin: 90mm

finishes

standard matt structure

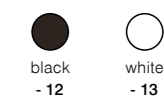

additional



all versions

Configure your product using the fold-out or our website.

LED integrated

power: dependent on version
CRI: CRI>90
CCT: 2700 | 3000K | 4000K
beam angle: 37° | 50°
dimming optional:
 DALI | switchDIM —
 RAFTER mix 94 LED recessed
 RAFTER mix 133 LED recessed
 RAFTER mix 136 LED recessed

RAFTER

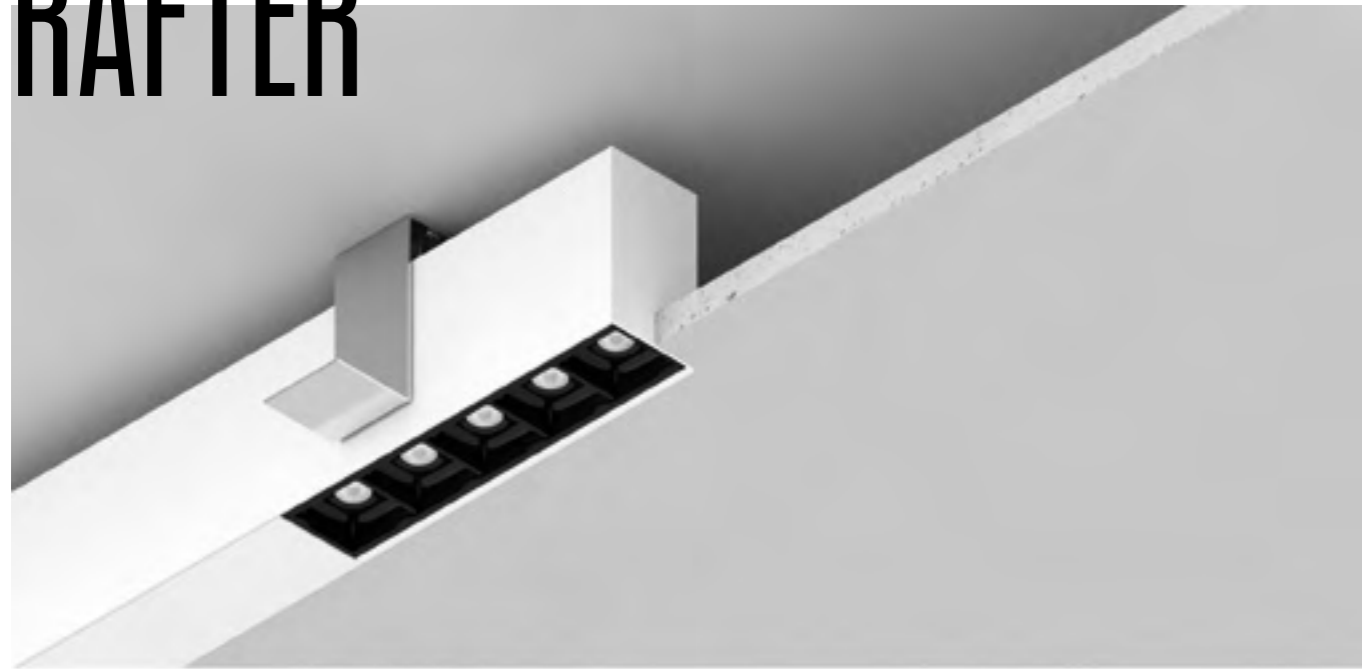

The RAFTER family of luminaires is a versatile lighting solution with a wide range of applications. The minimalist form with shapely dimensions hides excellent parameters guaranteeing high luminous efficacy and a large protection angle in the 'points' version. Easy installation, aesthetic appearance and functionality make the collection recommended for communication areas, large office spaces as well as home arrangements. The version with a milk cover will perfectly introduce neat general lighting not only to the living rooms but also to offices, restaurants or hotels.

Rodzina opraw RAFTER to wszechstronne oświetlenie o szerokim wachlarzu zastosowań. Minimalistyczna forma o zgrabnych gabarytach kryje znakomite parametry gwarantujące wysoką skuteczność świetlną oraz duży kąt ochrony w przypadku wersji „points”. Łatwy montaż, estetyczny wygląd oraz funkcjonalność sprawiają, że kolekcja polecana jest zarówno strefom komunikacyjnym, dużym przestrzeniom biurowym, jak i aranżacjom domowym. Wersja z mleczną przesłoną świetnie wprowadzi zgrabne oświetlenie ogólne nie tylko „na salony” ale i do biur, restauracji czy hoteli.



luminaire family

-  [p.158](#)  [p.336](#)
-  [p.216](#)  [p.422](#)
-  [p.268](#)

standard type

RAFTER LED recessed

aqform.com/RA0013

length	power	flux	cat. no
570mm	17.5W	2430lm	30275-M930-D9-00-11
860mm	26.0W	3640lm	30276-M930-D9-00-11
1140mm	35.0W	4860lm	30277-M930-D9-00-11
1420mm	43.5W	6070lm	30278-M930-D9-00-11
1700mm	52.0W	7290lm	30279-M930-D9-00-11

CRI>90 | 3000K | non dim

LED int 230V dim opt

37mm Hmin: 90mm

RAFTER points LED recessed

aqform.com/RA1013

length	power	flux	cat. no
270mm	10.0W	1230lm	30270-L930-W1-00-__
540mm	19.5W	2470lm	30271-L930-W1-00-__

CRI>90 | 3000K | 50° | non dim

LED int 230V dim opt UGR <13

37mm Hmin: 90mm

AQsmart RAFTER points LED section recessed

aqform.com/RA1613

length	power	flux	cat. no
540mm	10.0W	1230lm	30265-L930-W1-00-__
940mm	15.0W	1850lm	30266-L930-W1-00-__
1330mm	19.5W	2470lm	30267-L930-W1-00-__
1730mm	24.5W	3090lm	30268-L930-W1-00-__
2130mm	29.5W	3700lm	30269-L930-W1-00-__

CRI>90 | 3000K | 50° | non dim

LED int 230V dim opt UGR <13



37mm Hmin: 90mm

How lenses are placed in RAFTER points LED section



finishes



standard matt structure

for:
RAFTER points LED  
RAFTER points LED section black - 12 white - 13



standard natural aluminium

for:
RAFTER LED  - 11

additional

for:
RAFTER points LED section  - 19  - 17  - 16

additional gloss

for:
RAFTER points LED section  - 22  - 23

all versions

Configure your product using the fold-out or our website.

LED integrated

- power:**
RAFTER LED recessed
570mm — 9.0W | 17.5W | 25.0W
860mm — 13.0W | 26.0W | 37.5W
1140mm — 17.5W | 35.0W | 50.0W
1420mm — 22.0W | 43.5W | 62.5W
1700mm — 26.5W | 52.0W | 75.0W
RAFTER points LED recessed
540mm — 19.5W | 41.0W
RAFTER points LED section recessed
540mm — 10.0W | 20.5W
940mm — 15.0W | 31.0W
1330mm — 19.5W | 41.0W
1730mm — 24.5W | 51.5W
2130mm — 29.5W | 62.0W
CRI: CRI>90
CCT: 2700 | 3000K | 4000K
beam angle:
37° | 50° —
RAFTER points LED recessed
RAFTER points LED section recessed
dimming optional:
DALI | switchDIM —
RAFTER LED recessed
RAFTER points 54 LED recessed
DALI | AQsmart —
RAFTER points 54 LED section recessed
DALI | switchDIM | AQsmart —
RAFTER points 94 LED section recessed
RAFTER points 133 LED section recessed
RAFTER points 173 LED section recessed
RAFTER points 213 LED section recessed

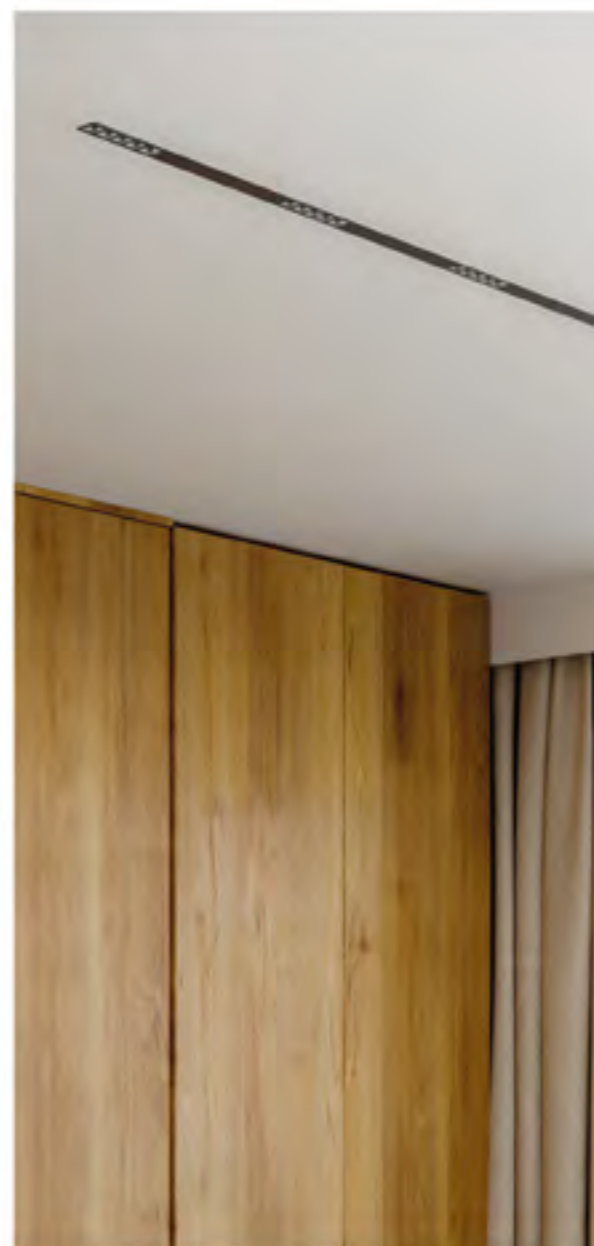

SET TRU



The TRU LED family of luminaires is a neat combination of well thought-out technical solutions and aesthetic appearance. Thanks to a wide range of applications, these luminaires fit into offices, communication zones as well as they can perform task lighting. The microprismatic cover used in the PRO version guarantees an additional increase in luminous efficacy and visual comfort of interior users – that's why it works best in office spaces. Moreover, versions with DALI control and tunable colour temperature allow you to adjust the light to the time of day and your current needs.

Rodzina opraw TRU LED to zgrabne połączenie przemyślanych rozwiązań technicznych z estetycznym wyglądem. Dzięki szerokiej gamie zastosowań oprawy te pasują do biur, stref komunikacyjnych, jak również mogą pełnić funkcję oświetlenia zadaniowego. Zastosowana w wersji PRO przesłona mikropryzmatyczna gwarantuje dodatkowo wzrost skuteczności świetlnej i podwyższenie komfortu wizualnego użytkowników wnętrza – dlatego najlepiej sprawdzi się w przestrzeniach biurowych. Z kolei wersje ze sterowaniem DALI i regulowaną temperaturą barwową pozwalają dostosować światło do pory dnia i aktualnych potrzeb.



luminaire family

-  [p.164](#)
-  [p.218](#)
-  [p.272](#)
-  [p.332](#)
-  [p.378](#)
-  [p.416](#)

standard type

SET TRU LED recessed

aqform.com/BC0022

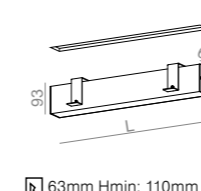

CRI>90 | 3000K | non dim

length	power	flux	cat. no
290mm	8.5W	1210lm	37840-M930-D9-00-13
570mm	17.5W	2430lm	37842-M930-D9-00-13
860mm	26.0W	3640lm	37846-M930-D9-00-13
1140mm	35.0W	4860lm	37848-M930-D9-00-13
1420mm	43.5W	6070lm	37850-M930-D9-00-13
1700mm	52.0W	7290lm	37852-M930-D9-00-13
1980mm	61.0W	8500lm	37854-M930-D9-00-13

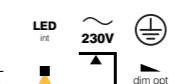

SET TRU PRO LED recessed

aqform.com/BC0022

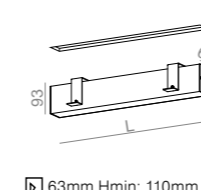

CRI>90 | 3000K | non dim

length	power	flux	cat. no
290mm	8.5W	1210lm	38008-M930-D5-00-13
570mm	17.5W	2430lm	38009-M930-D5-00-13
860mm	26.0W	3640lm	38010-M930-D5-00-13
1140mm	35.0W	4860lm	38004-M930-D5-00-13
1420mm	43.5W	6070lm	38005-M930-D5-00-13
1700mm	52.0W	7290lm	38006-M930-D5-00-13
1980mm	61.0W	8500lm	38007-M930-D5-00-13

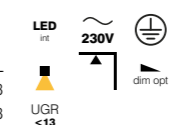

covers comparison



regular (opal)



PRO (microprism)

See PRO lighting effect on the website

finishes

standard matt structure



white
- 13

all versions

Configure your product using the fold-out or our website.

LED integrated

power:

290mm — 4.5W | 8.5W
570mm — 9.0W | 17.5W
860mm — 13.0W | 26.0W
1140mm — 17.5W | 35.0W
1420mm — 22.0W | 43.5W
1700mm — 26.5W | 52.0W
1980mm — 31.0W | 61.0W

CRI: CRI>90

CCT: 2700 | 3000K | 4000K | 2700-6500K¹

dimming optional:





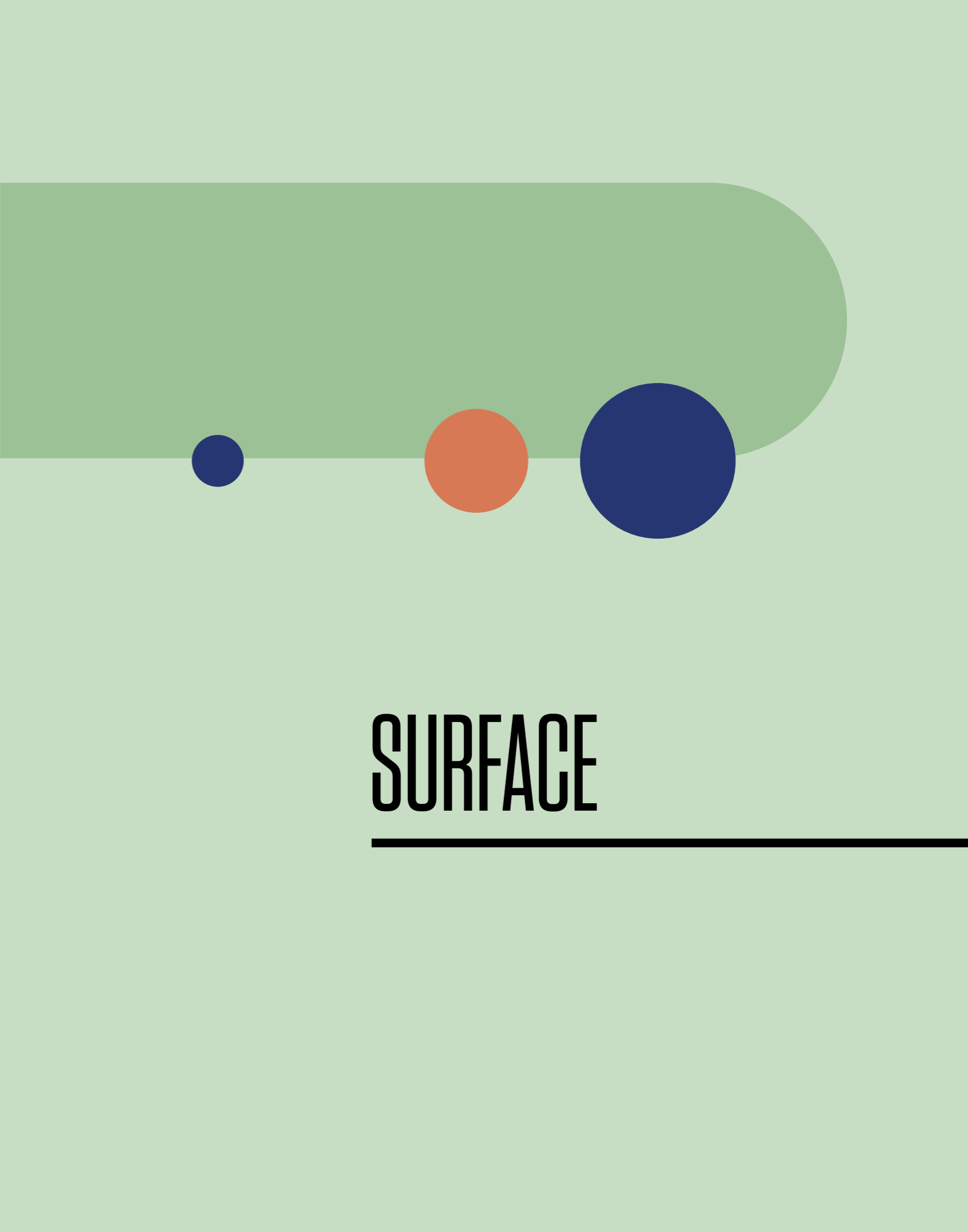

DALI | switchDIM —
from length 570mm







¹2700-6500K from length 1140mm















SURFACE







SURFACE





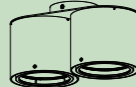

<p>MODERN BALL p. 104</p>  <p>new</p>	<p>MODERN BALL x2 p. 104</p>  <p>new</p>	<p>MODERN BALL x3 p. 104</p>  <p>new</p>	<p>MODERN BALL x4 p. 104</p>  <p>new</p>	<p>MODERN BALL x3 section p. 104</p>  <p>new</p>	<p>MODERN BALL x4 asymmetry p. 104</p>  <p>new</p>
--	---	---	---	---	---





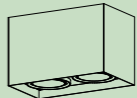

<p>PET next mini p. 106</p>  <p>new</p>	<p>PET next p. 106</p>  <p>new</p>	<p>PET next maxi p. 106</p>  <p>new</p>	<p>PET zoom p. 106</p>  <p>new</p>	<p>PET p. 106</p>  <p>new</p>	<p>MODERN GLASS Flared p. 110</p>  <p>new</p>
--	---	--	---	--	--



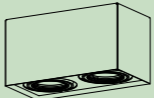

<p>MODERN GLASS Barrel p. 112</p>  <p>new</p>	<p>MODERN GLASS Tube p. 112</p>  <p>new</p>	<p>ONLY round mini p. 116</p>  <p>new</p>	<p>ONLY round p. 116</p>  <p>new</p>	<p>ONLY square p. 116</p>  <p>new</p>	<p>TUBA next 50 p. 118</p>  <p>new</p>
--	--	--	---	--	---

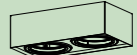



<p>TUBA 50 p. 118</p>  <p>new</p>	<p>TUBA distance 50x1 p. 118</p>  <p>new</p>	<p>TUBA distance 50x2 p. 118</p>  <p>new</p>	<p>TUBA 111 QRLED p. 120</p>  <p>new</p>	<p>TUBA distance 111x1 QRLED p. 120</p>  <p>new</p>	<p>TUBA distance 111x2 QRLED p. 120</p>  <p>new</p>
--	---	---	---	--	--





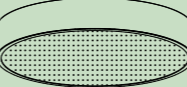
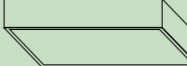

<p>TUBA 111 p. 122</p>  <p>new</p>	<p>TUBA distance 111x1 p. 122</p>  <p>new</p>	<p>TUBA distance 111x2 p. 122</p>  <p>new</p>	<p>REVEL dot p. 126</p>  <p>new</p>	<p>MAXI RING dot p. 126</p>  <p>new</p>	<p>REVEL p. 126</p>  <p>new</p>
---	--	--	--	--	--



<p>MAXI RING p. 126</p>  <p>new</p>	<p>QUPET mini p. 130</p>  <p>new</p>	<p>QUPET p. 130</p>  <p>new</p>	<p>SQUARES next 50x1 p. 132</p>  <p>new</p>	<p>SQUARES next 50x2 p. 132</p>  <p>new</p>	<p>SQUARES 50x1 p. 132</p>  <p>new</p>
--	---	--	--	--	---

<p>SQUARES 50x2 p. 132</p>  <p>new</p>	<p>SQUARES mini 111x1 QRLED p. 134</p>  <p>new</p>	<p>SQUARES mini 111x2 QRLED p. 134</p>  <p>new</p>	<p>SQUARES mini 111x1 p. 134</p>  <p>new</p>	<p>SQUARES mini 111x2 p. 134</p>  <p>new</p>	<p>SLEEK distance 111x1 QRLED p. 138</p>  <p>new</p>
---	---	---	---	---	---

<p>SLEEK distance 111x2 QRLED p. 138</p>  <p>new</p>	<p>SLEEK distance 111x3 QRLED p. 138</p>  <p>new</p>	<p>SLEEK distance 111x1 p. 138</p>  <p>new</p>	<p>SLEEK distance 111x2 p. 138</p>  <p>new</p>	<p>SLEEK distance 111x3 p. 138</p>  <p>new</p>	<p>BIG SIZE next round p. 142</p>  <p>new</p>
---	---	---	---	---	--

<p>BIG SIZE PRO next round p. 142</p>  <p>new</p>	<p>BIG SIZE next square p. 144</p>  <p>new</p>	<p>BIG SIZE PRO next square p. 144</p>  <p>new</p>	<p>equilibra p. 146</p>  <p>new</p>	<p>LENS LINE p. 148</p>  <p>new</p>	<p>LENS LINE 180x89 RC p. 148</p>  <p>new</p>
--	---	---	--	--	--

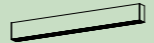
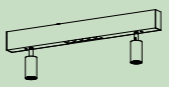
<p>LENS LINE 89x89 SQ p. 148</p>  <p>new</p>	<p>MIXLINE p. 150</p>  <p>new</p>	<p>MIXLINE INV p. 150</p>  <p>new</p>	<p>MIXLINE 120x89 RT p. 150</p>  <p>new</p>	<p>SET RAW mini p. 156</p>  <p>new</p>	<p>RAFTER p. 158</p>  <p>new</p>
---	--	--	--	---	---

<p>RAFTER points p. 158</p>  <p>new</p>	<p>RAFTER mix p. 160</p>  <p>new</p>	<p>SET TRU p. 164</p>  <p>new</p>	<p>SET TRU PRO p. 164</p>  <p>new</p>
--	---	--	--

MODERN BALL

Designed in collaboration with DECHEM

new



Do you need another BALL compositions? Contact us.¹

Minimalistic and at the same time unusual design is a timeless trend in interior design. The geometric curves of MODERN BALL are definitely being a trendy decoration in any arrangement. The luminaire emits soft, pleasant light, so it works great as general lighting, also in large spaces. It can be successfully used as a signpost in a dark traffic route or effective lighting of a table or reception. Milk-glass ensures our visual comfort, protecting the eyes from unpleasant glare. MODERN BALL is also a good complementary solution – mounted on the wall, these luminaires create a moody atmosphere.

Minimalistyczny, a przy tym nietuzinkowy design to ponadczasowy trend w projektowaniu wnętrz. Zdecydowanie wpisują się w niego geometryczne krągłości MODERN BALL będące modną ozdobą każdej aranżacji. Oprawa emituje miękkie, przyjemne światło, dlatego świetnie sprawdzi się jako oświetlenie ogólne, również dużych przestrzeni. Z powodzeniem posłuży jako drogowy znak w ciemnym ciągu komunikacyjnym lub efektowne oświetlenie stołu czy recepcji. Mleczne szkło zapewnia komfort wizualny, chroniąc wzrok przed oślnieniem. MODERN BALL to także dobre rozwiązanie uzupełniające – oprawy zamontowane na ścianie tworzą nastrojowy klimat.



function

luminaire family

 p.170

 p.288

standard type

MODERN BALL WP LED surface

aqform.com/MB1014

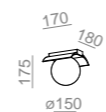

CRI>90 | 3000K | non dim

power	flux	cat. no
6.0W	880lm	46970-L930-D0-00-__
9.0W	1200lm	46970-M930-D0-00-__

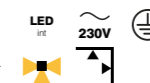

MODERN BALL WP x2 LED surface

aqform.com/MB2014

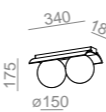

CRI>90 | 3000K | non dim

power	flux	cat. no
12.5W	1770lm	46971-L930-D0-00-__
18.0W	2410lm	46971-M930-D0-00-__

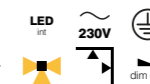

AQsmart MODERN BALL WP x3 LED surface

aqform.com/MB3014

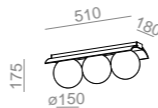

CRI>90 | 3000K | non dim

power	flux	cat. no
18.5W	2660lm	46972-L930-D0-00-__
26.5W	3620lm	46972-M930-D0-00-__

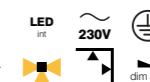

AQsmart MODERN BALL WP x4 LED surface

aqform.com/MB4014

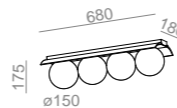

CRI>90 | 3000K | non dim

power	flux	cat. no
25.0W	3550lm	46973-L930-D0-00-__
35.5W	4830lm	46973-M930-D0-00-__

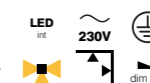

AQsmart MODERN BALL WP x3 LED section surface

aqform.com/MB3614

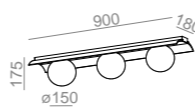

CRI>90 | 3000K | non dim

power	flux	cat. no
18.5W	2660lm	46998-L930-D0-00-__
26.5W	3620lm	46998-M930-D0-00-__

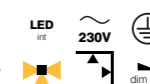

AQsmart MODERN BALL WP x4 LED asymmetry surface

aqform.com/MB4414

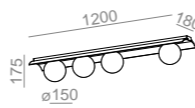

CRI>90 | 3000K | non dim

power	flux	cat. no
25.0W	3550lm	46999-L930-D0-00-__
35.5W	4830lm	46999-M930-D0-00-__

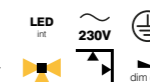

finishes

standard matt structure

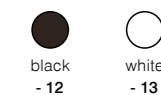

additional

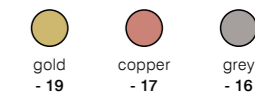

all versions

Configure your product using the fold-out or our website.

LED integrated

- power: dependent on version
- CRI: CRI>90
- CCT: 2700K | 3000K | 4000K
- dimming optional:
- DALI —
 - MODERN BALL WP x2 LED surface
 - DALI | AQsmart —
 - MODERN BALL WP x3 LED surface
 - MODERN BALL WP x4 LED surface
 - MODERN BALL WP x3 LED section surface
 - MODERN BALL WP x4 LED asymmetry surface

PET



Balanced form of PET fixtures is a neat combination of subtlety and elegance. The minimalist design and excellent parameters of LED luminaires create a uniquely harmonious duo. For supporters of traditional solutions, retrofit lamp version is available. A single PET luminaire emphasizes the important details of the arrangement, creates mood or highlights the special nature of the exhibition. In a group – it provides effective task lighting, brightens communication zones, and with properly selected parameters, will serve as general lighting. PET is a timelessness and utility enclosed in a shapely form.

Wyważona forma opraw PET to zgrabne połączenie subtelności oraz elegancji. Minimalistyczny design oraz znakomite parametry opraw LED tworzą wyjątkowo zgrabny duet. Dla zwolenników tradycyjnych rozwiązań dostępna jest wersja na wymienne źródła światła. Oprawa PET zamocowana solo akcentuje istotne detale aranżacji, tworzy nastrojową atmosferę lub podkreśla szczególnie charakter ekspozycji. W grupie – stanowi skuteczne oświetlenie zadaniowe, rozświetla strefy komunikacyjne, a przy odpowiednio dobranych parametrach, posłuży jako oświetlenie ogólne. PET to ponadczasowość i użyteczność zamknięte w zgrabnej bryle.



luminaire family

-  [p.174](#)  [p.362](#)
-  [p.228 / 230 / 232](#)
-  [p.392](#)

standard type

NEW

PET next mini LED surface

aqform.com/PE1814



CRI>90 | 3000K | 36° | non dim

length	power	flux	cat. no
120mm	4.5W	520lm	46959-M930-F1-00-__
200mm	4.5W	520lm	46960-M930-F1-00-__
320mm	4.5W	520lm	46961-M930-F1-00-__



NEW

PET next LED surface

aqform.com/PE0814



CRI>90 | 3000K | 35° | non dim

length	power	flux	cat. no
120mm	8.5W	1170lm	46962-M930-F1-00-__
200mm	8.5W	1170lm	46963-M930-F1-00-__
320mm	8.5W	1170lm	46964-M930-F1-00-__



QS Q4 2020 black
QS Q4 2020 white

NEW

PET next maxi LED surface

aqform.com/PE2814



CRI>90 | 3000K | 32° | non dim

length	power	flux	cat. no
120mm	17.0W	2330lm	46965-M930-F1-00-__
200mm	17.0W	2330lm	46966-M930-F1-00-__
320mm	17.0W	2330lm	46967-M930-F1-00-__



11.5W — available additional power

PET zoom LED 230V surface

aqform.com/PE2074



CRI>90 | 3000K | 20-41° | Phase-Control

length	power	flux	cat. no
120mm	8.0W	620lm	46953-M930-Z3-PH-__
170mm	8.0W	620lm	46954-M930-Z3-PH-__
250mm	8.0W	620lm	46955-M930-Z3-PH-__

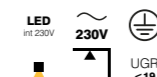

PET surface

aqform.com/PE9034



PAR16, 230V | GU10 | Phase-Control

length	power	flux	cat. no
90mm	8.0W	QS	42311-0000-U8-PH-__
170mm	8.0W	QS	46311-0000-U8-PH-__
250mm	8.0W		46411-0000-U8-PH-__
500mm	8.0W		40298-0000-U8-PH-__



QS black
QS white

finishes

standard matt structure

QS for PET surface
from 01.2021

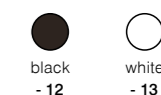

additional

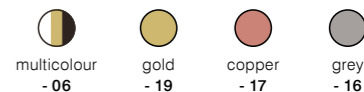

additional gloss

for:

PET zoom LED 230V surface
PET surface

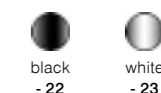

additional white-black

for:

PET next mini LED surface
PET next LED surface
PET next maxi LED surface



all versions

Configure your product using
the fold-out or our website.

LED integrated

power: dependent on version
CRI: CRI>90
CCT: 2700K | 3000K | 4000K
beam angle:
20° | 36° — PET next mini LED surface
18° | 35° — PET next LED surface
19° | 32° — PET next maxi LED surface

dimming optional:

DALI —
PET next 20 LED surface
PET next 32 LED surface
PET next maxi 20 LED surface
PET next maxi 32 LED surface

LED 230V integrated

power: 8.0W
CRI: CRI>90
CCT: 2700K | 3000K | 4000K
beam angle: 20-26-33-41°
dimming standard: Phase-Control

PAR16, 230V

power: max: LED 8.0W
dimming standard: Phase-Control
light source not included



Restaurant Seafood Station, Sopot | design: Sikora Wnętrza | photo: Tom Kurek



private apartment, Gdynia | design: Sikora Wnętrza | photo: Paweł Mądry

MODERN GLASS

Designed in collaboration with DECHEM



The MODERN GLASS collection is the story of search for an archetypal form of lighting. A shape that, while remaining friendly, brings a fresh look. When observing the play of light and glass, it turned out that the most beautiful effects are obtained using simple forms of a tube or cone. If the glass has the right thickness, the light gently flows around its surface. Therefore, glass luminaires allow you to neatly combine the decorative function with comfortable light and thus become an increasingly popular addition to many interiors. The MODERN GLASS collection was created in cooperation with the Czech design studio DECHEM.

Kolekcja MODERN GLASS to historia poszukiwania archetypowej formy oświetlenia. Kształtu, który pozostając przyjaźnie znajomym wnosi świeże spojrzenie. Podczas obserwacji gry światła i szkła okazało się, że najpiękniejsze efekty dają proste formy tuby czy stożka. Jeżeli szkło ma odpowiednią grubość, światło delikatnie opływa jego powierzchnię. Dlatego szklane lampy pozwalają zgrabnie połączyć funkcję ozdobną z komfortowym światłem i dzięki temu stają się coraz popularniejszym dodatkiem wielu wnętrz. Kolekcja MODERN GLASS powstała we współpracy z czeskim studium projektowym DECHEM.



luminaire family

-  [p.176](#)
-  [p.292](#)
-  [p.352](#)

standard type

glass finishes Flared



TP SP TR WP

glass finishes Barrel



TP SP TR WP

glass finishes Tube



TP SP TR WP

MODERN GLASS Flared LED 230V surface

aqform.com/MG2014



CRI>90 | 3000K | Phase-Control

glass	power	flux	cat. no
TP	6.0W	500lm	40408-M930-D9-PH-__
SP	6.0W	500lm	40450-M930-D9-PH-__
WP	6.0W	500lm	46936-M930-D9-PH-__
TR	6.0W	500lm	40418-M930-D9-PH-__

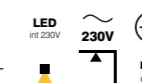

MODERN GLASS Flared E27 surface

aqform.com/MG2024



Standard | E27 | Phase-Control

glass	power	cat. no
TP	max: LED 13.0W	40405-0000-U8-PH-__
SP	max: LED 13.0W	40447-0000-U8-PH-__
WP	max: LED 13.0W	46933-0000-U8-PH-__
TR	max: LED 13.0W	40415-0000-U8-PH-__



MODERN GLASS Flared GU10 surface

aqform.com/MG2034



PAR16, 230V | GU10 | Phase-Control

glass	power	cat. no
TP	max: LED 8.0W	40402-0000-U8-PH-__
SP	max: LED 8.0W	40444-0000-U8-PH-__
WP	max: LED 8.0W	46930-0000-U8-PH-__
TR	max: LED 8.0W	40412-0000-U8-PH-__



finishes

standard matt structure



additional



all versions

Configure your product using the fold-out or our website.

LED 230V integrated

power: 6.0W
CRI: CRI>90
CCT: 2700K | 3000K | 4000K
dimming standard: Phase-Control

Standard E27

power: max: LED 13.0W
dimming standard: Phase-Control
light source not included

PAR16, 230V

power: max: LED 8.0W
dimming standard: Phase-Control
light source not included

standard type

MODERN GLASS Barrel LED 230V surface

aqform.com/MG1014



CRI>90 | 3000K | Phase-Control

glass	power	flux	cat. no
TP	6.0W	500lm	40409-M930-D9-PH-__
SP	6.0W	500lm	40451-M930-D9-PH-__
WP	6.0W	500lm	46937-M930-D9-PH-__
TR	6.0W	500lm	40419-M930-D9-PH-__



MODERN GLASS Barrel E27 surface

aqform.com/MG1024



Standard | E27 | Phase-Control

glass	power	cat. no
TP	max: LED 13.0W	40406-0000-U8-PH-__
SP	max: LED 13.0W	40448-0000-U8-PH-__
WP	max: LED 13.0W	46934-0000-U8-PH-__
TR	max: LED 13.0W	40416-0000-U8-PH-__

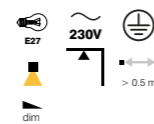

MODERN GLASS Barrel GU10 surface

aqform.com/MG1034



PAR16, 230V | GU10 | Phase-Control

glass	power	cat. no
TP	max: LED 8.0W	40403-0000-U8-PH-__
SP	max: LED 8.0W	40445-0000-U8-PH-__
WP	max: LED 8.0W	46931-0000-U8-PH-__
TR	max: LED 8.0W	40413-0000-U8-PH-__

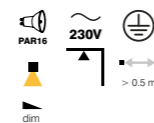

MODERN GLASS Tube LED 230V surface

aqform.com/MG3014

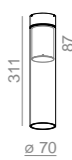

CRI>90 | 3000K | Phase-Control

glass	power	flux	cat. no
TP	6.0W	500lm	40407-M930-D9-PH-__
SP	6.0W	500lm	40449-M930-D9-PH-__
WP	6.0W	500lm	46935-M930-D9-PH-__
TR	6.0W	500lm	40417-M930-D9-PH-__

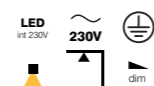

MODERN GLASS Tube E27 surface

aqform.com/MG3024

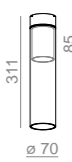

T30, 230V | E27 | Phase-Control

glass	power	cat. no
TP	max: LED 13.0W	40404-0000-U8-PH-__
SP	max: LED 13.0W	40446-0000-U8-PH-__
WP	max: LED 13.0W	46932-0000-U8-PH-__
TR	max: LED 13.0W	40414-0000-U8-PH-__

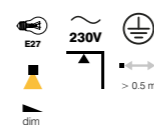

MODERN GLASS Tube GU10 surface

aqform.com/MG3034

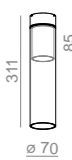

PAR16, 230V | GU10 | Phase-Control

glass	power	cat. no
TP	max: LED 8.0W	40401-0000-U8-PH-__
SP	max: LED 8.0W	40461-0000-U8-PH-__
WP	max: LED 8.0W	46929-0000-U8-PH-__
TR	max: LED 8.0W	40410-0000-U8-PH-__



finishes

standard matt structure

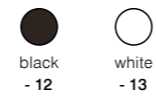

additional



all versions

Configure your product using the fold-out or our website.

LED 230V integrated

power: 6.0W
CRI: CRI>90
CCT: 2700K | 3000K | 4000K
dimming standard: Phase-Control

Standard E27

power: max: LED 13.0W
dimming standard: Phase-Control
light source not included

PAR16, 230V

power: max: LED 8.0W
dimming standard: Phase-Control
light source not included



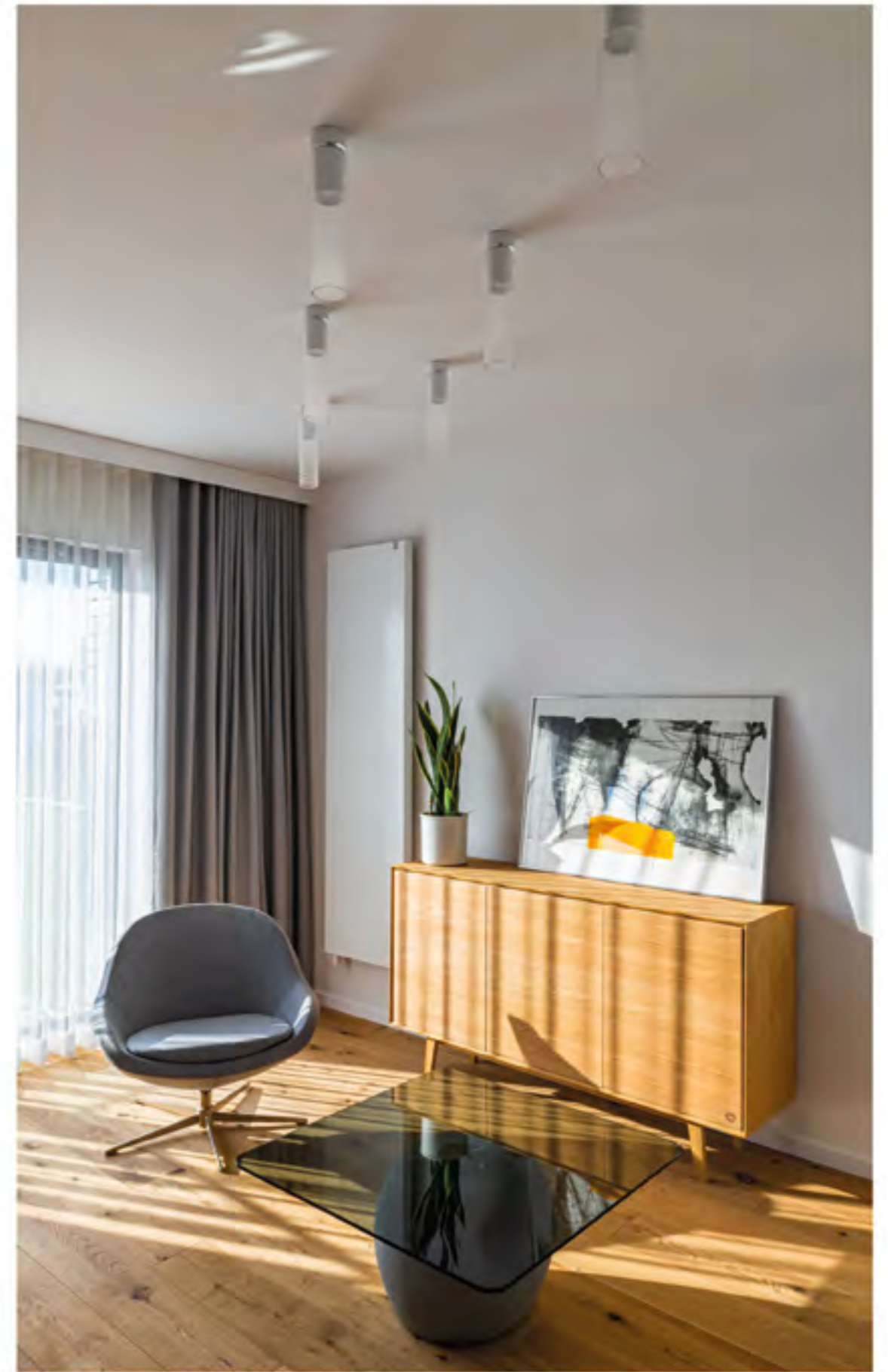

ONLY

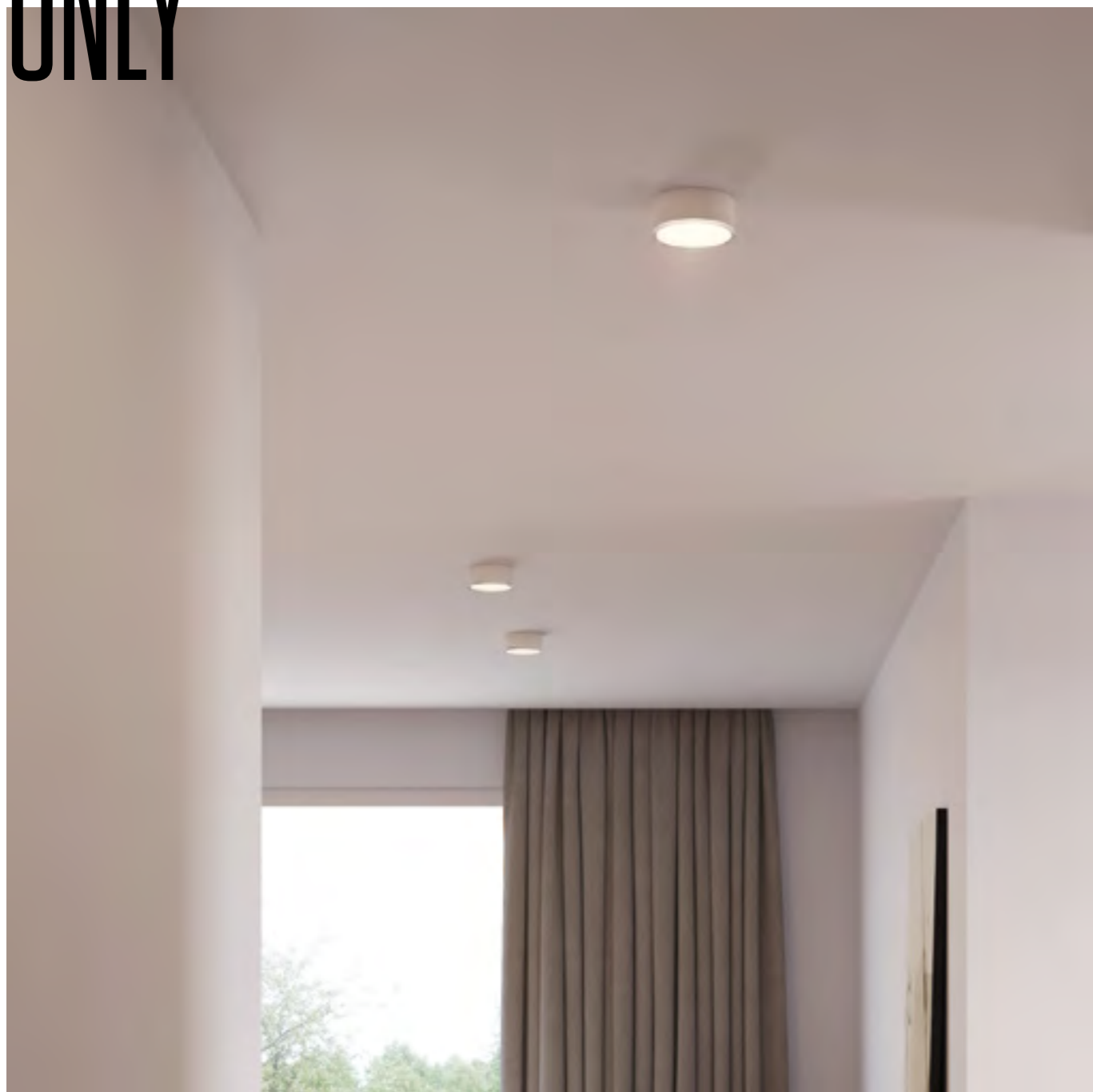

Every detail counts in a stylish interior. The ONLY luminaire with an integrated LED light source creates a nice mood when we feel like watching a movie or diving into the world of a favorite book. It will serve as a light signpost in labyrinths of corridors, and also light up the space with gently diffused light. Thanks to the small size and low height, it will not overwhelm the interior with its form, and the high colour rendering index will ensure vivid and saturated colours. This makes ONLY luminaires a great solution for both private and commercial spaces.

W stylowym wnętrzu liczy się każdy detal. Oprawa ONLY ze zintegrowanym źródłem światła LED tworzy nastrojową atmosferę, kiedy mamy ochotę obejrzeć film lub zagłębić się w świecie ulubionej lektury. Posłuży jako świetlny drogowskaz w labiryntach korytarzy, a także oświetli przestrzeń delikatnie rozproszonym światłem. Dzięki niewielkim gabarytom i małej wysokości nie przytłoczy wnętrza swoją formą, a wysoki współczynnik odwzorowania barw zapewni żywe i nasycone kolory. To powoduje, że oprawy ONLY są świetnym rozwiązaniem zarówno dla przestrzeni prywatnych, jak i komercyjnych.



luminaire family

[p.356](#)

standard type

ONLY round mini 10 LED 230V surface

aqform.com/ON1014

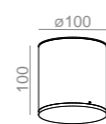

CRI>90 | 3000K | Phase-Control

power	flux	cat. no
8.0W	620lm	40462-M930-D9-PH-__

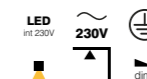

ONLY round 6 LED 230V surface

aqform.com/ON0114

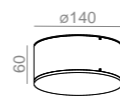

CRI>90 | 3000K | Phase-Control

power	flux	cat. no
8.0W	620lm	45312-L930-D9-PH-__
12.0W	920lm	45312-M930-D9-PH-__

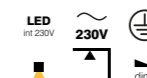

ONLY square LED 230V surface

aqform.com/ON0214

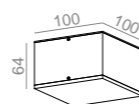

CRI>90 | 3000K | Phase-Control

power	flux	cat. no
8.0W	620lm	45313-L930-D9-PH-__
12.0W	920lm	45313-M930-D9-PH-__

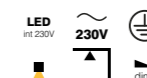

finishes

standard matt structure

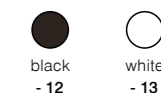

additional

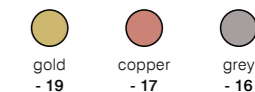

additional gloss

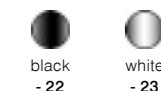

all versions

Configure your product using the fold-out or our website.

LED 230V integrated

power: dependent on version
CRI: CRI>90
CCT: 2700K | 3000K | 4000K
dimming standard: Phase-Control

TUBA 50



The subtle form of the cylinder combined with a minimalist design makes TUBA 50 a discreet ally of modern arrangements. Timelessness and elegance enchanted in a raw form. TUBA 50 emphasizes elements that give the room a special character, enveloping their outline with light. This fitting will also ensure our good mood, creating an atmosphere of relaxation after a hard day. Used in a group, TUBA 50 is an excellent task lighting, which not only lights up the work-top's working surface with great intensity, but also shows the way in the dark corridor.

Subtelna forma walca połączona z dobrym wzornictwem czyni oprawę TUBA 50 dyskretnym sprzymierzeńcem nowoczesnych aranżacji. Ponadczasowość i elegancja zakłętę w surowej bryle. TUBA 50 świetnie akcentuje elementy, które nadają pomieszczeniu szczególny charakter, otulając światłem ich zarys. Oprawa ta zadba także o nasz dobry nastrój, kreując atmosferę odprężenia po ciężkim dniu. TUBA 50 użyta w grupie, to doskonałe oświetlenie zadaniowe, które nie tylko z dużym natężeniem oświetli powierzchnię roboczą blatu, ale także wyznaczy drogę w ciemnym korytarzu.



standard type

NEW

TUBA next 50 LED surface

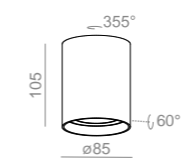

CRI>90 | 3000K | 36° | non dim

power	flux	cat. no
6.0W	800lm	46975-M930-F1-00-__

aqform.com/TU3814

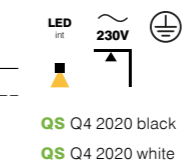

TUBA 50 230V surface

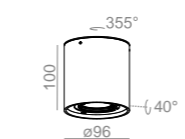

PAR16, 230V | GU10 | Phase-Control

power	cat. no
max: 35.0W	45921-0000-U8-PH-__

aqform.com/45921

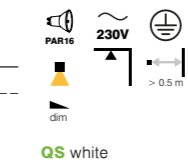

TUBA distance 50x1 230V surface

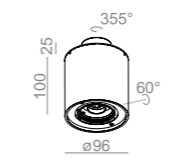

PAR16, 230V | GU10 | Phase-Control

power	cat. no
max: 35.0W	45941-0000-U8-PH-__

aqform.com/45941

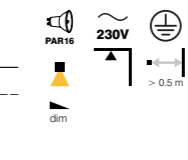

TUBA distance 50x2 230V surface

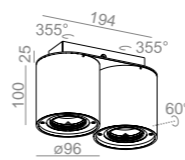

PAR16, 230V | GU10 | Phase-Control

power	cat. no
max: 2x 35.0W	45935-0000-U8-PH-__

aqform.com/45935

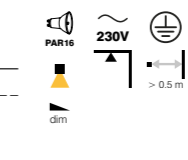

finishes

standard matt structure

QS for TUBA 50 230V
from 01.2021



additional

for:

TUBA 50 230V
TUBA distance 50x1 230V
TUBA distance 50x2 230V

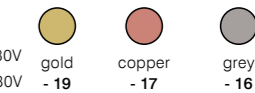

additional gloss

for:

TUBA 50 230V
TUBA distance 50x1 230V
TUBA distance 50x2 230V

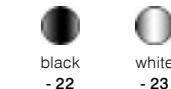

additional white-black

for:

TUBA next 50 LED



all versions

Configure your product using the fold-out or our website.

LED integrated

power: 6.0W
CRI: CRI>90
CCT: 3000K | 4000K
beam angle: 36°

PAR16, 230V

power: max: LED 35.0W
dimming standard: Phase-Control
light source not included

TUBA 111 QRLED



private apartment, Lublin | design: ASABA DESIGN Studio Projektowania Wnętrz

TUBA 111 QRLED with an integrated LED light source combines elegant minimalism with geometric form. This timeless, always fashionable duo makes this luminaire perfectly emphasize the modern character of the interior. Precise light will effectively brighten pictures, flowers or a coffee table. Thanks to the high colour rendering index, the colours are vivid and pleasing to the eye. Using several luminaires at the same time will become an effective task lighting solution for large interiors or communication zones.

TUBA 111 QRLED ze zintegrowanym źródłem światła LED łączy elegancki minimalizm z geometryczną formą. Ten ponadczasowy, zawsze modny duet sprawia, że oprawa ta świetnie podkreśla nowoczesny charakter wnętrza. Precyzyjne światło skutecznie oświetli obrazy, kwiaty czy stół kawowy. Dzięki wysokiemu współczynnikowi odwzorowania barw, kolory są żywe i przyjemne dla oka. Użycie kilku opraw jednocześnie stanie się efektywnym oświetleniem zadaniowym, które rozświetli duże wnętrza lub strefy komunikacyjne.



luminaire family

 [p.192](#)

 [p.258](#)

standard type

TUBA 111 11 QRLED surface

aqform.com/TU0064

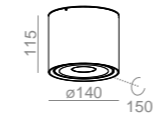

CRI>90 | 3000K | 38° | non dim

power	flux	cat. no
6.0W	880lm	40222-L930-F1-00-__
9.0W	1200lm	40222-M930-F1-00-__



TUBA 111 11 QRLED 230V surface

aqform.com/TU0164

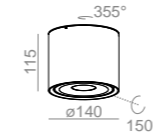

CRI>90 | 3000K | 38° | Phase-Control

power	flux	cat. no
8.0W	620lm	40224-M930-F1-PH-__
12.0W	920lm	40224-H930-F1-PH-__

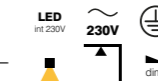

TUBA distance 111x1 QRLED surface

aqform.com/TU3964

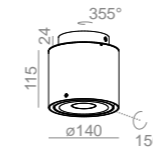

CRI>90 | 3000K | 38° | non dim

power	flux	cat. no
6.0W	880lm	40226-L930-F1-00-__
9.0W	1200lm	40226-M930-F1-00-__



TUBA distance 111x1 QRLED 230V surface

aqform.com/TU3264

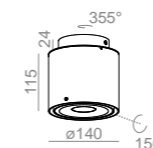

CRI>90 | 3000K | 38° | Phase-Control

power	flux	cat. no
8.0W	620lm	40228-M930-F1-PH-__
12.0W	920lm	40228-H930-F1-PH-__

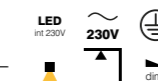

TUBA distance 111x2 QRLED surface

aqform.com/TU4964

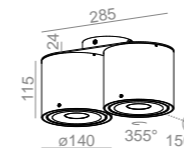

CRI>90 | 3000K | 38° | non dim

power	flux	cat. no
12.5W	1770lm	40230-L930-F1-00-__
18.0W	2410lm	40230-M930-F1-00-__

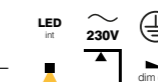

TUBA distance 111x2 QRLED 230V surface

aqform.com/TU4264

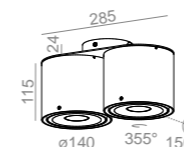

CRI>90 | 3000K | 38° | Phase-Control

power	flux	cat. no
16.0W	1240lm	40232-M930-F1-PH-__
24.0W	1840lm	40232-H930-F1-PH-__

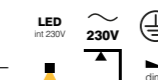

finishes

standard matt structure



additional



all versions

Configure your product using the fold-out or our website.

LED integrated

power: dependent on version
CRI: CRI>90
CCT: 2700K | 3000K | 4000K
beam angle: 38°
dimming optional: Phase-Control

LED 230V integrated

power: dependent on version
CRI: CRI>90
CCT: 2700K | 3000K | 4000K
beam angle: 38°
dimming standard: Phase-Control

TUBA 111





Lighting in a shapely, cylindrical form is a solution that will be appreciated by all admirers of timeless solutions. The round shape of the frame in white or black finish will always work, regardless of the circumstances. More extravagant colours – such as copper or gold – will accent the design's composition. Traditional light sources AR111 or ES111 are mounted in a swing ring that can be directed to the selected object or surface. A stylish and convenient solution.

Oświetlenie o zgrabnej, walcowatej formie to rozwiązanie, które docenią wszyscy wielbicieli ponadczasowych rozwiązań. Obły kształt oprawy w wykończeniu białym lub czarnym sprawdzi się zawsze, niezależnie od okoliczności. Bardziej ekstrawaganckie kolory, takie jak miedź czy złoty, pozwolą zaakcentować kompozycję projektu. Wymienne źródła światła AR111 lub ES111 są zamocowane w wychylnym pierścieniu, który można skierować na wybrany obiekt czy powierzchnię. Szykowne i wygodne rozwiązanie.



luminaire family

-  [p.192](#)
-  [p.258](#)
-  [p.320](#)

standard type

TUBA 111 11 surface

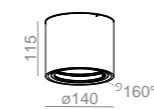

AR111, 12V AC | G53 | Phase-Control

power

max: 35.0W, LED 12.5W

cat. no

45611-0000-T8-PH-__

aqform.com/TU9054

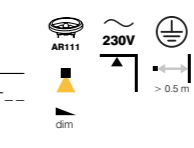

QS black

QS white

TUBA 111 11 230V surface

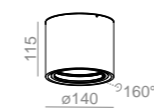

ES111, 230V | GU10 | Phase-Control

power

max: 35.0W

cat. no

45711-0000-U8-PH-__

aqform.com/TU9064

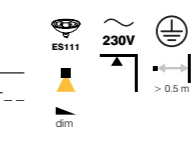

QS white

TUBA distance 11x1 surface



AR111, 12V AC | G53 | Phase-Control

power

max: 35.0W, LED 12.5W

cat. no

45603-0000-T8-PH-__

aqform.com/45603

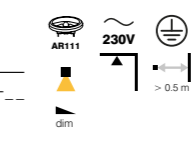

TUBA distance 11x1 230V surface



ES111, 230V | GU10 | Phase-Control

power

max: 35.0W

cat. no

45602-0000-U8-PH-__

aqform.com/45602

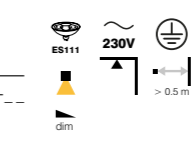

TUBA distance 11x2 surface

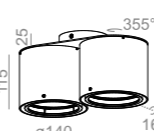

AR111, 12V AC | G53 | Phase-Control

power

max: 2x 35.0W, LED 12.5W

cat. no

45630-0000-T8-PH-__

aqform.com/45630

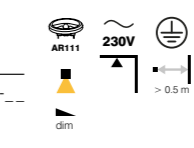

TUBA distance 11x2 230V surface

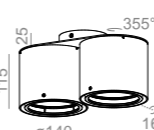

ES111, 230V | GU10 | Phase-Control

power

max: 2x 35.0W

cat. no

45632-0000-U8-PH-__

aqform.com/45632

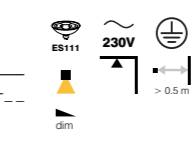

finishes

standard matt structure

QS from 01.2021

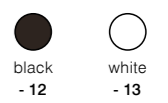

additional



additional gloss



all versions

Configure your product using the fold-out or our website.

AR111, 12V AC

power: max: 35.0W, LED 12.5W
dimming standard: Phase-Control
light source not included

ES111, 230V

power: max: 35.0W
dimming standard: Phase-Control
light source not included

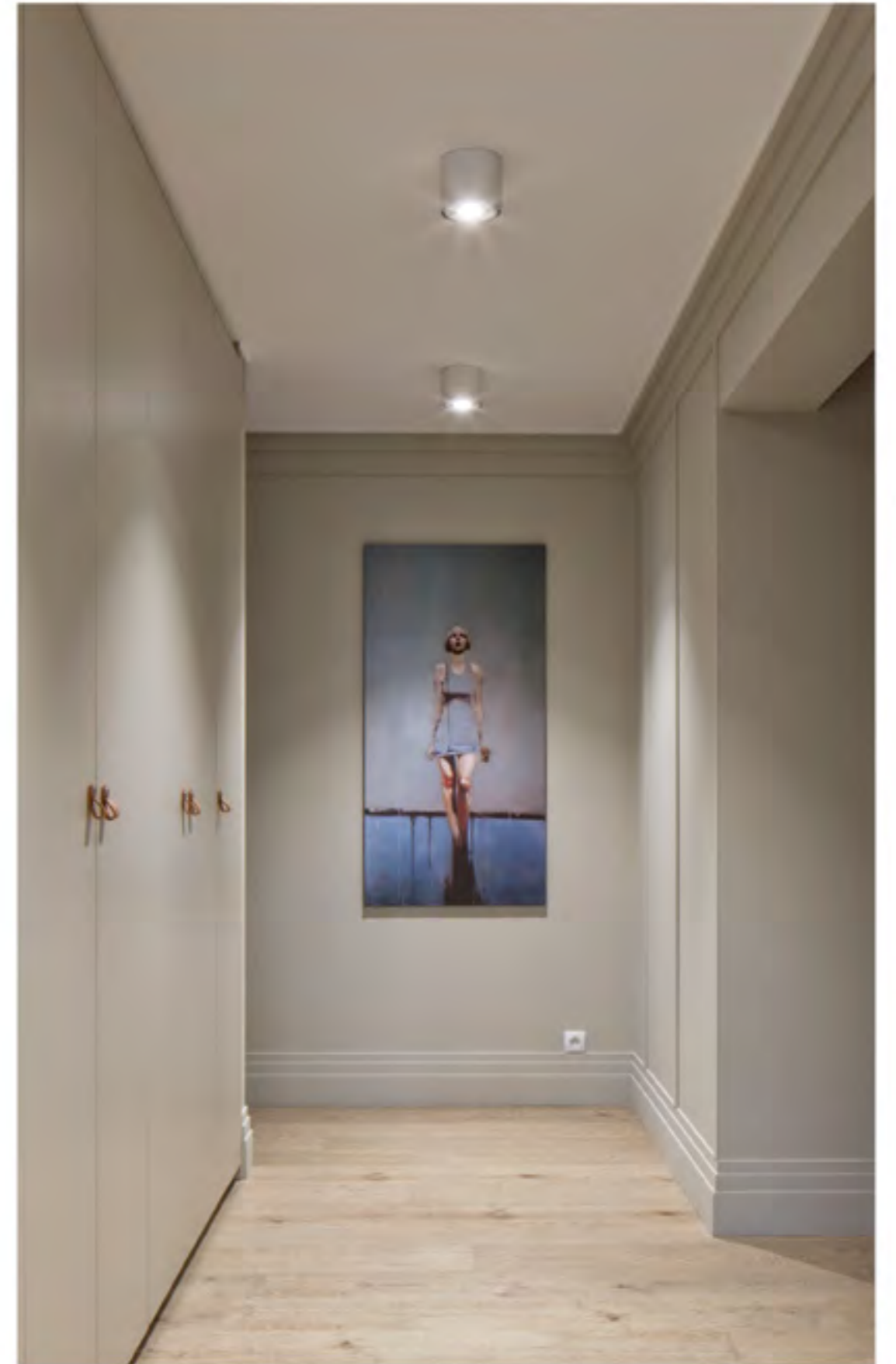

MAXI RING / REVEL



The first edition of MAXI RING has already been recognized for its design by the jury of the Good Design competition. The collection combining aesthetics and functionality without compromise has been expanded with smaller REVEL and a more homely dot series, which again gained the recognition of the jury of the Good Design competition. MAXI RING and REVEL will light up a huge foyer or gently break the twilight at home. They allow to use AQsmart, and in the Tunable-White version they can imitate the CCT of sunlight. The dot version allows to create an unusual atmosphere, regardless of mounting on the ceiling or wall.

Już pierwsza odsłona MAXI RING została doceniona za wzornictwo przez jury konkursu Dobry Wzór. Kolekcja bez kompromisów łącząca estetykę i funkcjonalność została poszerzona o mniejsze oprawy REVEL i bardziej domową serię dot, która kilka lat później też zdobyła uznanie kapituły konkursu Dobry Wzór. MAXI RING i REVEL rozświetlą ogromne foyer lub delikatnie przełamają półmrok w domowym zaciszu. Umożliwiają sterowanie AQsmart, a w wersji Tunable-White pozwalają naśladować temperaturę barwową światła słonecznego. Wersja dot daje możliwość stworzenia niezwykłego klimatu, niezależnie czy oprawa będzie zamocowana na suficie czy na ścianie.



luminaire family

--- [p.076](#)

--- [p.184](#)

standard type



REVEL dot LED 230V surface

aqform.com/RE1074



CRI>80 | 3000K | Phase-Control

power	flux	cat. no
20.5W	2230lm	40429-M830-D0-PH-__

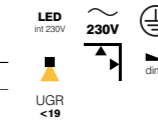

MAXI RING dot LED 230V surface

aqform.com/MR1074

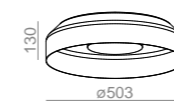

CRI>80 | 3000K | Phase-Control

power	flux	cat. no
30.5W	3500lm	40426-M830-D0-PH-__

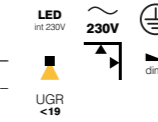

AQsmart

REVEL LED surface

aqform.com/RE0014



CRI>90 | 3000K | non dim

power	flux	cat. no
8.5W	1270lm	40427-L930-D9-00-__
17.0W	2550lm	40427-M930-D9-00-__



AQsmart

MAXI RING LED surface

aqform.com/MR0014



CRI>90 | 3000K | non dim

power	flux	cat. no
14.5W	2230lm	45936-L930-D9-00-__
30.0W	4460lm	45936-M930-D9-00-__

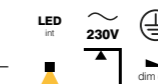

finishes

standard matt structure



additional



additional multicolour

for:
REVEL dot LED 230V surface
MAXI RING dot LED 230V surface



multicolour
- 06

additional white-black

for:
REVEL dot LED 230V surface
MAXI RING dot LED 230V surface



white-black
- 46

all versions

Configure your product using the fold-out or our website.

LED integrated

power: dependent on version
CRI: CRI>90
CCT:
3000K | 4000K | 2700-6500K —
MAXI RING LED surface
3000K | 4000K —
REVEL LED surface
dimming optional: DALI | switchDIM | AQsmart

LED 230V integrated

power: dependent on version
CRI: CRI>80
CCT: 2700 | 3000K | 4000K
dimming standard: Phase-Control

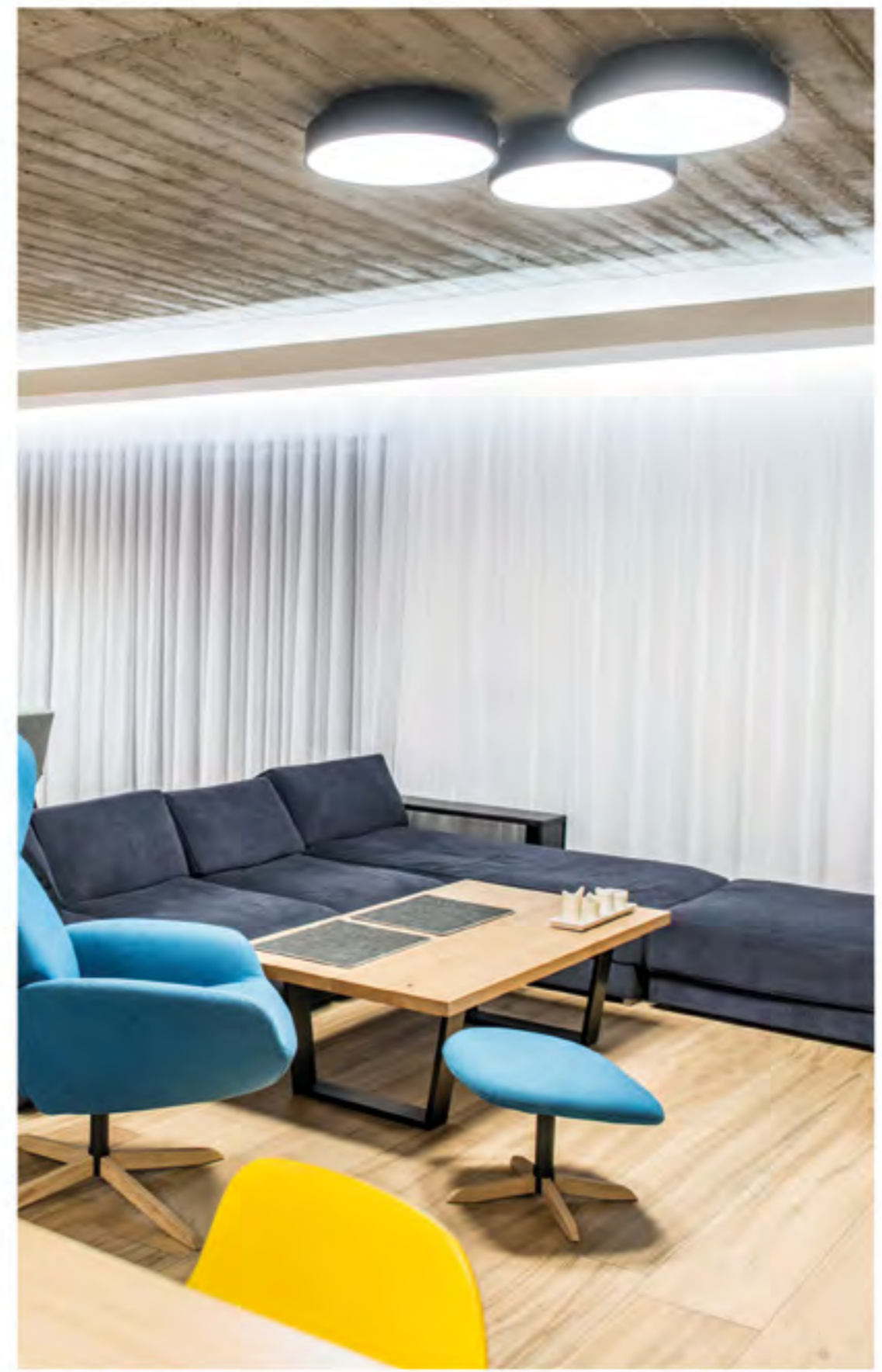

QUPET



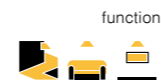

Each composition begins with simple elements. The unpretentious form of the QUPET collection is great for minimalist arrangements. Combining these luminaires into a group or mixing different lengths allows you to get impressive compositions. Individual QUPET luminaires are great for lighting communication spaces. They invite the play of light and shadow in apartments and rooms intended for rest. In larger groups, they even cope with large spaces, and their parameters allow you to create constellations of lamps with no worries about energy efficiency.

Każda kompozycja zaczyna się od prostych elementów. Bezpretensjonalność formy kolekcji QUPET świetnie sprawdza się w minimalistycznych aranżacjach. Z kolei połączenie opraw w grupę lub zestawienie różnych długości pozwala uzyskać imponujące kompozycje. Pojedyncze oprawy QUPET wyśmienicie radzą sobie z oświetleniem przestrzeni komunikacyjnych. Pozwalają na grę światła i cienia w mieszkaniach i pomieszczeniach przeznaczonych do wypoczynku. W większych grupach radzą sobie nawet z dużymi przestrzeniami, a ich parametry pozwalają tworzyć konstelacje lamp bez obaw o energooszczędność.



luminaire family

-  [p.196](#)
-  [p.246](#)
-  [p.314](#)

standard type

QUPET mini LED surface

aqform.com/QU1014



CRI>90 | 3000K | 36° | non dim

length	power	flux	cat. no
170mm	3.0W	380lm	40439-M930-F1-00-__
250mm	3.0W	380lm	40440-M930-F1-00-__
370mm	3.0W	380lm	40441-M930-F1-00-__
500mm	3.0W	380lm	40468-M930-F1-00-__



QUPET 9 surface

aqform.com/QU9034

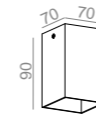

PAR16, 230V | GU10 | Phase-Control

power	cat. no
max: 8.0W	42411-0000-U8-PH-__

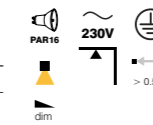

finishes

standard matt structure



additional

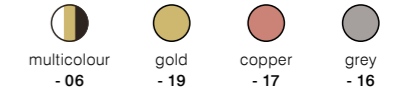

additional gloss



all versions

Configure your product using the fold-out or our website.

LED integrated

power: 3.0W
CRI: CRI>90
CCT: 2700 | 3000K | 4000K
beam angle: 20° | 36°

PAR16, 230V

power: max: 8.0W
dimming standard: Phase-Control
light source not included

SQUARES 50



private apartment 65m², Dobczyce | design: PROJEKTYW - Paulina Zwolak, Jakub Nieć | photo: WNEŹRZA KRAKÓW - Jakub Dziedzic

The well-known series has gained a new version: next. LED solutions are not only energy-saving, but also guarantee high quality of light. SQUARES next means reduced flicker and even greater luminous efficacy. Direct current (DC) power supply and the use of the latest LED modules allowed, despite lower power, to obtain over 25% greater flux. The thoughtful design makes assembly easier. High colour rendering will ensure that the colours of all objects will be vivid also after dark. The SQUARES 50 family also gives the version where traditional light source can be used.

Dobrze znana seria zyskuje nową odsłonę: wersję next. Rozwiązania LED to nie tylko energooszczędność, ale i wysoka jakość światła. SQUARES next oznacza zmniejszone tętnienie przy jeszcze większej skuteczności świetlnej. Stałoprądowy zasilacz i zastosowanie najnowszych modułów LED pozwoliło, mimo mniejszej mocy oprawy, uzyskać ponad 25% większy strumień świetlny. Przemyślana konstrukcja ułatwia montaż. Wysokie odwzorowanie barw sprawi, że kolory wszystkich przedmiotów będą żywe także po zmroku. Rodzina SQUARES 50 posiada również wersję, w której można zastosować tradycyjne źródło światła.



luminaire family

--- [p.058](#) / [060](#)

standard type

NEW

SQUARES next 50x1 LED surface

aqform.com/SX1814

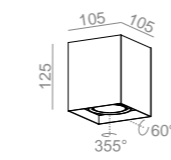

CRI>90 | 3000K | 36° | non dim

power	flux	cat. no
6.0W	800lm	46968-M930-F1-00-__

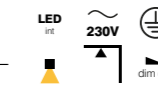

QS Q4 2020 black

QS Q4 2020 white

NEW

SQUARES next 50x2 LED surface

aqform.com/SX2814

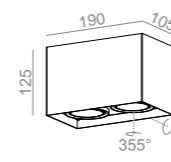

CRI>90 | 3000K | 36° | non dim

power	flux	cat. no
12.0W	1610lm	46969-M930-F1-00-__

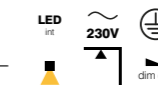

QS Q4 2020 black

QS Q4 2020 white

SQUARES 50x1 230V surface

aqform.com/45811

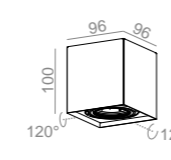

PAR16, 230V | GU10 | Phase-Control

power	cat. no
max: 35.0W	45811-0000-U8-PH-__



QS white

SQUARES 50x2 230V surface

aqform.com/45812

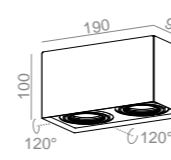

PAR16, 230V | GU10 | Phase-Control

power	cat. no
max: 2x 35.0W	45812-0000-U8-PH-__



QS white

finishes

standard matt structure



additional

for:
SQUARES 50x1 230V
SQUARES 50x2 230V



additional multicolour

for:
SQUARES 50x1 230V
SQUARES 50x2 230V



additional white-black



all versions

Configure your product using the fold-out or our website.

LED integrated

power: 6.0W
CRI: CRI>90
CCT: 3000K | 4000K
beam angle: 36°
dimming optional: DALI

PAR16, 230V

power: max: 35.0W
dimming standard: Phase-Control
light source not included

SQUARES 111



Gabinety Psychoterapii „Przystań Terapeutyczna”, Kraków | design: Dorota Oramus

Dormant power in an inconspicuous fixture – meet SQUARES mini. Lamps with the AR111 source can cope with accents, even from long distances. In the integrated versions, the QRLED module will easily replace halogen and allow you to save energy while enjoying light with CRI>90 (colours look as if they were in the sunlight) and low flicker, which ensures our eyes' comfort. SQUARES mini technical solutions enable low operating costs with high quality light at the same time.

Moc drzemiąca w niepozornej oprawie – poznajcie SQUARES mini. Lampy ze źródłem AR111 świetnie poradzą sobie z akcentowaniem, nawet z dużych odległości. W wersjach zintegrowanych, moduł QRLED bez problemu zastąpi halogen i pozwoli oszczędzać energię ciesząc się przy tym światłem o CRI>90 (kolory wyglądają tak pięknie, jakby były oświetlone światłem słonecznym) i niskim tętnieniem, które zapewnia komfort naszym oczom. Zastosowane w SQUARES mini rozwiązania techniczne umożliwiają niskie koszty eksploatacji przy jednocześnie wysokiej jakości światła.



luminaire family

— p.064 / 066

standard type

SQUARES mini 111x1 QRLED surface

aqform.com/SQ1164

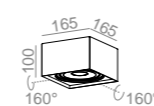

CRI>90 | 3000K | 38° | non dim

power	flux	cat. no
6.0W	880lm	40200-L930-F1-00-__
9.0W	1200lm	40200-M930-F1-00-__

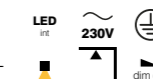

AQsmart SQUARES mini 111x2 QRLED surface

aqform.com/SQ1264

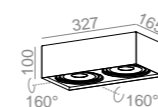

CRI>90 | 3000K | 38° | non dim

power	flux	cat. no
12.5W	1770lm	40202-L930-F1-00-__
18.0W	2410lm	40202-M930-F1-00-__

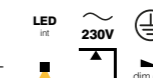

SQUARES mini 111x1 surface

aqform.com/40110

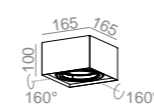

AR111, 12V AC | G53 | Phase-Control

power	cat. no
max: 35.0W, LED 12.5W	40110-0000-T8-PH-__

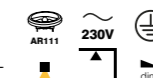

—> 0.5 m
QS white

SQUARES mini 111x2 surface

aqform.com/40111

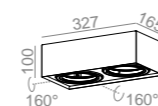

AR111, 12V AC | G53 | Phase-Control

power	cat. no
max: 2x 35.0W, LED 12.5W	40111-0000-T8-PH-__



—> 0.5 m
QS white

finishes

standard matt structure

QS from 01.2021



additional



additional white-black

for:

SQUARES mini 111x1 surface

SQUARES mini 111x2 surface



all versions

Configure your product using the fold-out or our website.

LED integrated

power: dependent on version

CRI: CRI>90

CCT: 2700K | 3000K | 4000K

beam angle: 38°

dimming optional:

Phase-Control —

SQUARES mini 111x1 QRLED surface

Phase-Control | DALI | switchDIM | AQsmart —

SQUARES mini 111x2 QRLED surface

AR111, 12V AC

power: max: 35.0W, LED 12.5W

dimming standard: Phase-Control

light source not included



SLEEK



N.M. House | Lublin | design: OMCD Architects | photo: trzykropy

With a height of less than 7cm, SLEEK will fit perfectly into low interiors, while versions x2 and x3 this size will cope with higher and bigger spaces. Integrated QRLED versions allow the use of DALI-compatible power supplies and of advanced control options. Wall lamps and recessed versions accompanying the surface-mounted SLEEK luminaires, make it easy to maintain style consistency between interiors with different ceiling designs and functionalities.

Dzięki wysokości poniżej 7cm, SLEEK idealnie wpasuje się do niskich wnętrz, podczas gdy wersje o rozmiarze x2 i x3 poradzą sobie również z wyższymi i większymi przestrzeniami. Zintegrowane wersje QRLED pozwalają na zastosowanie zasilaczy zgodnych z DALI i korzystanie z zaawansowanych możliwości sterowania. Towarzystwujące natynkowym oprawom SLEEK kinkiety i wersje wpuszczane, ułatwiają utrzymanie spójności stylu między wnętrzami o różnych konstrukcjach sufitu i funkcjonalnościach.



luminaire family

- p.072
- p.324

standard type

SLEEK distance 111x1 QRLED surface

aqform.com/SL3964

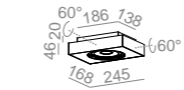

CRI>90 | 3000K | 38° | non dim

power	flux	cat. no
6.0W	880lm	40210-L930-F1-00-__
9.0W	1200lm	40210-M930-F1-00-__



AQsmart SLEEK distance 111x2 QRLED surface

aqform.com/SL4964

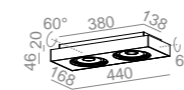

CRI>90 | 3000K | 38° | non dim

power	flux	cat. no
12.5W	1770lm	40212-L930-F1-00-__
18.0W	2410lm	40212-M930-F1-00-__



AQsmart SLEEK distance 111x3 QRLED surface

aqform.com/SL5964



CRI>90 | 3000K | 38° | non dim

power	flux	cat. no
18.5W	2660lm	40285-L930-F1-00-__
26.5W	3620lm	40285-M930-F1-00-__



SLEEK distance 111x1 surface

aqform.com/46612

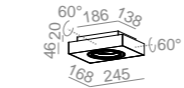

AR111, 12V AC | G53 | Phase-Control

power	cat. no
max: 50.0W, LED 12.5W	46612-0000-T8-PH-__

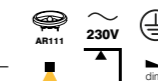

> 0.5 m
QS black
QS white

SLEEK distance 111x2 surface

aqform.com/46613

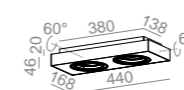

AR111, 12V AC | G53 | Phase-Control

power	cat. no
max: 2x 50.0W, LED 12.5W	46613-0000-T8-PH-__



> 0.5 m
QS white

SLEEK distance 111x3 surface

aqform.com/46614

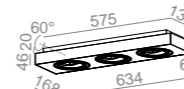

AR111, 12V AC | G53 | Phase-Control

power	cat. no
max: 3x 50.0W, LED 12.5W	46614-0000-T8-PH-__



> 0.5 m

finishes

standard matt structure

QS from 01.2021



additional



additional gloss

for:

SLEEK distance 111x1 surface
SLEEK distance 111x2 surface
SLEEK distance 111x3 surface



additional multicolour



all versions

Configure your product using the fold-out or our website.

LED integrated

power: dependent on version

CRI: CRI>90

CCT: 2700K | 3000K | 4000K

beam angle: 38°

dimming optional:

Phase-Control —
SLEEK distance 111x1 QRLED surface
Phase-Control | DALI | switchDIM | AQsmart —
SLEEK distance 111x2 QRLED surface
DALI | switchDIM | AQsmart —
SLEEK distance 111x3 QRLED surface

AR111, 12V AC

power: max: 35.0W, LED 12.5W

dimming standard: Phase-Control
light source not included

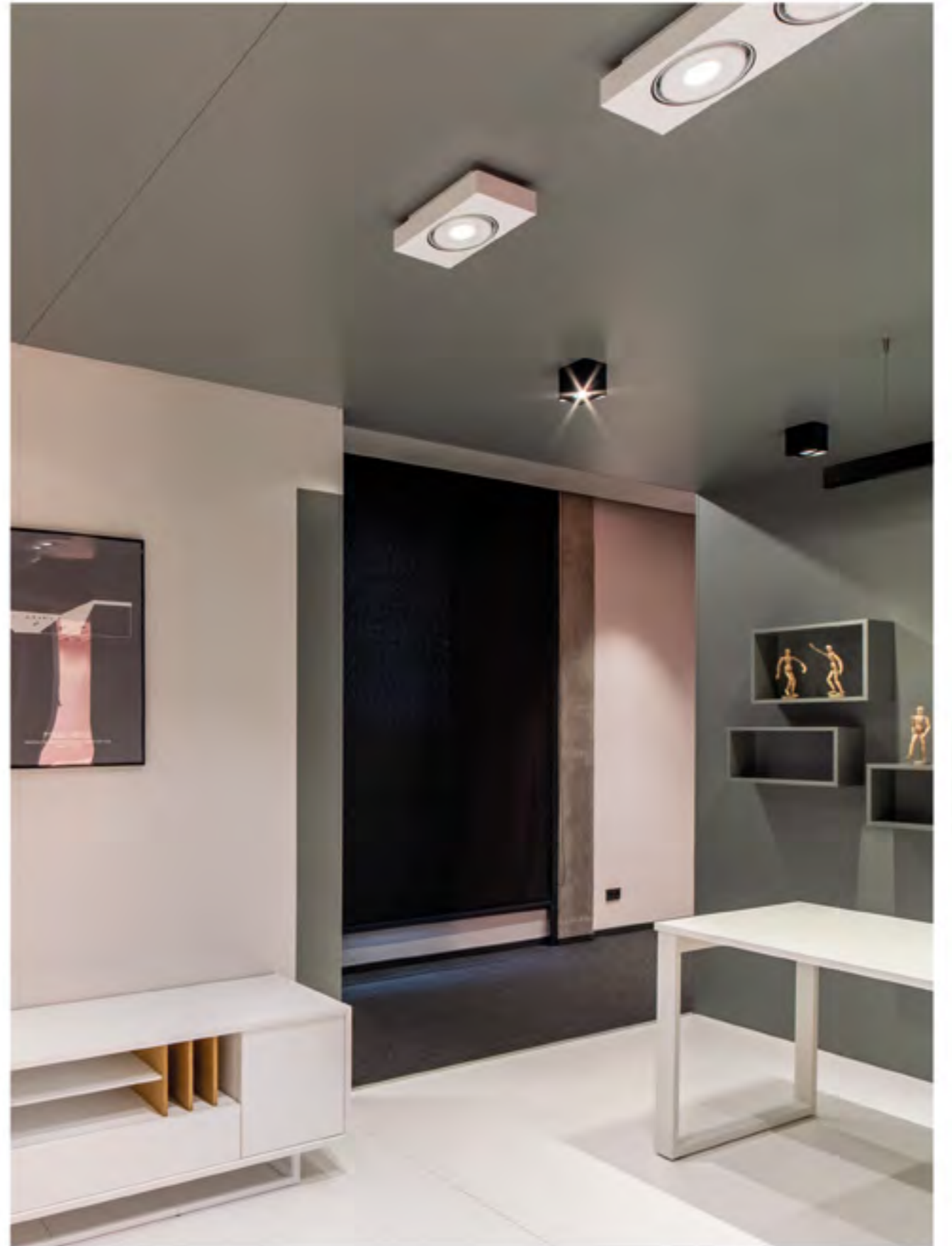
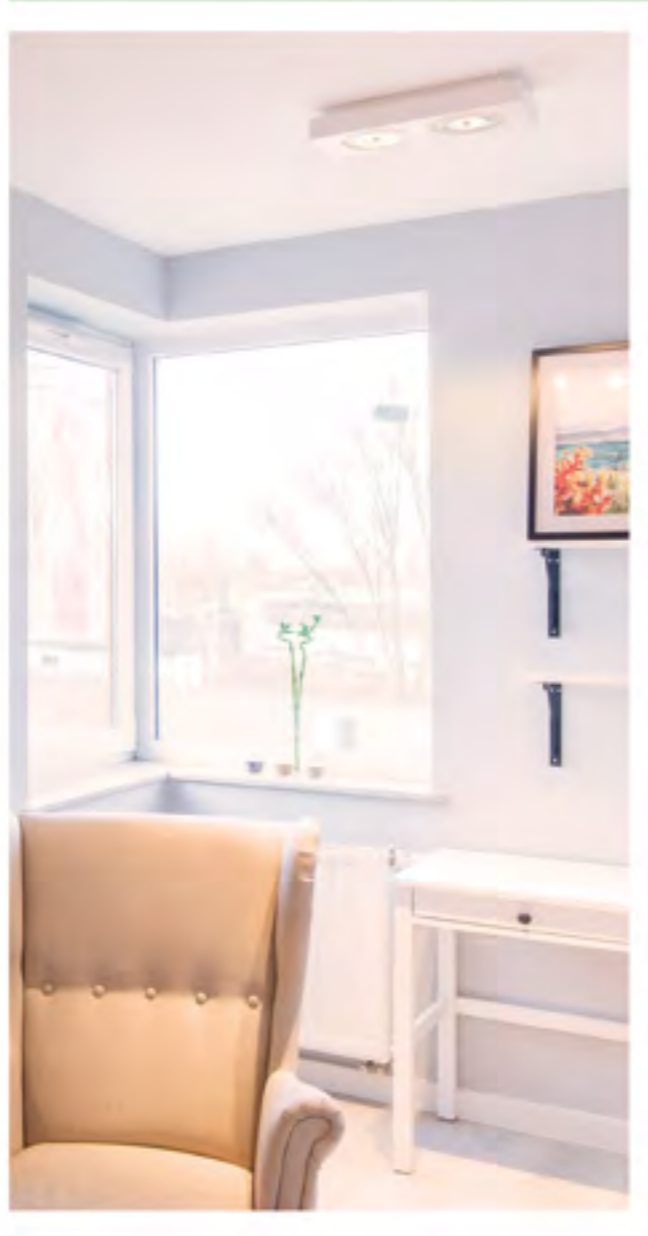

BIG SIZE round



Designed for large areas BIG SIZE round, it can easily brighten even a dozen m² with a single luminaire. In the PRO version, it will provide soft and delicate light despite high power and allow UGR<19 to be obtained wherever necessary. Simple power control is already available in the basic versions, and the most advanced ones also allow colour temperature control via DALI or Aqsmart. Possible BIG SIZE configurations and sizes from 45cm to over 120cm allow you to customize the lighting for each task.

Zaprojektowany dla rozległych powierzchni BIG SIZE round, potrafi bez trudu rozświetlić nawet kilkanaście m² pojedynczą oprawą. W wersji PRO zapewni miękkie i delikatne światło pomimo osiągniętych wysokich mocy i pozwoli uzyskać UGR<19 wszędzie, gdzie to niezbędne. Prosta regulacja mocy jest dostępna już w wersjach podstawowych, a te najbardziej zaawansowane umożliwiają też sterowanie temperatury barwowej poprzez DALI lub Aqsmart. Możliwe konfiguracje BIG SIZE i rozmiary od 45cm do przeszło 120cm, pozwalają dostosować oświetlenie do każdego zadania.



luminaire family

--- [p.078](#)

--- [p.200](#)

standard type

AQsmart BIG SIZE next round LED surface aqform.com/BS1114

CRI>90 | 3000K | non dim

diameter	power (min-max)	flux (min-max)	cat. no
450mm	10.0 – 17.5W	1530 – 2670lm	46976-A930-D9-00-__
660mm	21.5 – 38.5W	3310 – 5790lm	40237-A930-D9-00-__
960mm	39.5 – 71.0W	6120 – 10700lm	40238-A930-D9-00-__
1220mm	72.5 – 130.0W	11220 – 19620lm	40239-A930-D9-00-__



AQsmart BIG SIZE PRO next round LED surface aqform.com/BS1114

CRI>90 | 3000K | non dim

diameter	power (min-max)	flux (min-max)	cat. no
450mm	10.0 – 17.5W	1530 – 2670lm	46977-A930-D5-00-__
660mm	21.5 – 38.5W	3310 – 5790lm	46978-A930-D5-00-__
960mm	39.5 – 71.0W	6120 – 10700lm	46979-A930-D5-00-__
1220mm	72.5 – 130.0W	11220 – 19620lm	46980-A930-D5-00-__



UGR <19

covers comparison



regular (opal)



PRO (microprism)

See PRO lighting effect on the website

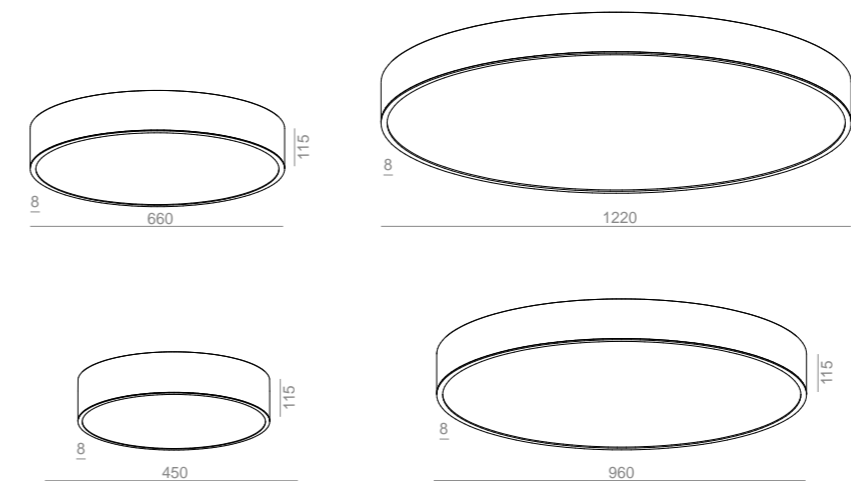

finishes

standard matt structure



additional



all versions

Configure your product using the fold-out or our website.

LED integrated

power:

ø450mm — 10.0 – 17.5W¹ | 30.0W²
 ø660mm — 21.5 – 38.5W¹ | 70.0W²
 ø960mm — 39.5 – 71.0W¹ | 150.0W²
 ø1220mm — 72.5 – 130.0W¹ | 250.0W²

CRI: CRI>90

CCT: 3000K | 4000K | 2700-6500K

dimming optional: DALI | switchDIM | Aqsmart

¹ adjustable power is available for CCT 3000K and 4000K

² Tunable-White (2700-6500K) has power always set for M and requires DALI or Aqsmart control

BIG SIZE square



The large power range, various sizes and minimalist design make the BIG SIZE square work great in rooms from 5 to 5000m², and then even in larger ones. Thanks to the regulated power, high efficiency and wide light distribution, which allows you to light up the floor at a high intensity and brighten up the walls at the same time – using BIG SIZE you can design lighting for large areas without straining the project's budget. Thanks to efficient light sources and high cover transmission, BIG SIZE square will obtain a lot of light economically.

Duża rozpiętość mocy, wiele rozmiarów i bezpretensjonalny design powodują, że BIG SIZE square świetnie sprawdza się w pomieszczeniach od 5 do 5000m², a nawet i większych. Dzięki regulowanej mocy, wysokiej efektywności i szerokiemu rozsyłowi światła, który pozwala równocześnie oświetlić z dużym natężeniem podłogę i doświetlić ściany – z BIG SIZE można zaprojektować oświetlenie dużych powierzchni bez nadwyrężenia budżetu projektu. Dzięki wydajnym źródłom światła i wysokiej przepuszczalności przestony, BIG SIZE square pozwala w ekonomiczny sposób uzyskać dużo światła.



luminaire family

--- [p.080](#)

--- [p.202](#)

standard type

AQsmart

BIG SIZE next square LED surface

aqform.com/BS1214

CRI>90 | 3000K | non dim

size	power (min-max)	flux (min-max)	cat. no
300x600mm	13.0 – 23.5W	2040 – 3560lm	40249-A930-D9-00-__
300x900mm	20.0 – 35.5W	3060 – 5350lm	40250-A930-D9-00-__
300x1200mm	26.5 – 47.0W	4080 – 7130lm	40251-A930-D9-00-__
600x600mm	26.5 – 47.0W	4080 – 7130lm	40252-A930-D9-00-__
600x900mm	39.5 – 71.0W	6120 – 10700lm	40253-A930-D9-00-__
600x1200mm	53.0 – 94.5W	8160 – 14270lm	40254-A930-D9-00-__
900x900mm	59.5 – 106.0W	9180 – 16050lm	40255-A930-D9-00-__
900x1200mm	69.5 – 124.0W	10710 – 18730lm	40256-A930-D9-00-__
1200x1200mm	92.5 – 165.0W	14280 – 24970lm	40257-A930-D9-00-__

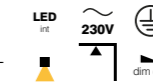

AQsmart

BIG SIZE PRO next square LED surface

aqform.com/BS1214

CRI>90 | 3000K | non dim

size	power (min-max)	flux (min-max)	cat. no
300x600mm	13.0 – 23.5W	2040 – 3560lm	46983-A930-D5-00-__
300x900mm	20.0 – 35.5W	3060 – 5350lm	46984-A930-D5-00-__
300x1200mm	26.5 – 47.0W	4080 – 7130lm	46982-A930-D5-00-__
600x600mm	26.5 – 47.0W	4080 – 7130lm	46986-A930-D5-00-__
600x900mm	39.5 – 71.0W	6120 – 10700lm	46987-A930-D5-00-__
600x1200mm	53.0 – 94.5W	8160 – 14270lm	46985-A930-D5-00-__
900x900mm	59.5 – 106.0W	9180 – 16050lm	46989-A930-D5-00-__
900x1200mm	69.5 – 124.0W	10710 – 18730lm	46988-A930-D5-00-__
1200x1200mm	92.5 – 165.0W	14280 – 24970lm	46981-A930-D5-00-__

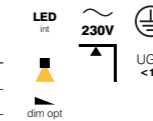

covers comparison



regular (opal)



PRO (microprism)

See PRO lighting effect on the website

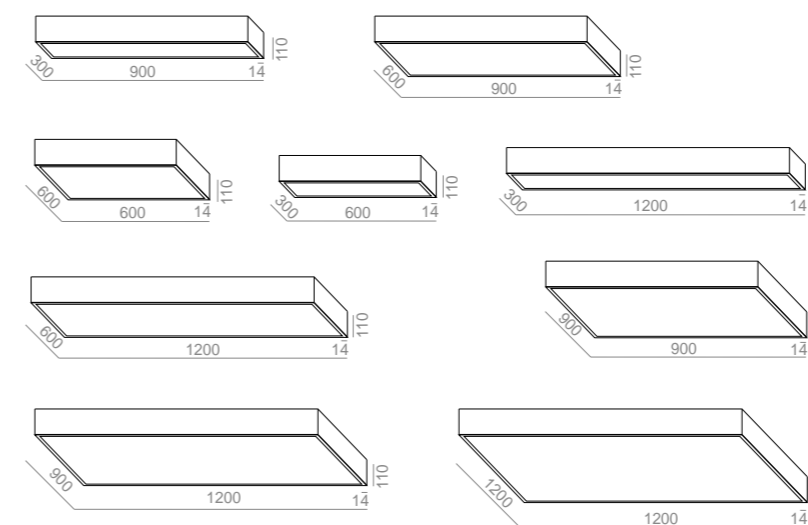

finishes

standard matt structure



additional



all versions

Configure your product using the fold-out or our website.

LED integrated

power:

300x600mm — 13.0 – 23.5W¹ | 40.0W²
 300x900mm — 20.0 – 35.5W¹ | 60.0W²
 300x1200mm — 26.5 – 47.0W¹ | 80.0W²
 600x600mm — 26.5 – 47.0W¹ | 80.0W²
 600x900mm — 39.5 – 71.0W¹ | 120.0W²
 600x1200mm — 53.0 – 94.5W¹ | 160.0W²
 900x900mm — 59.5 – 106.0W¹ | 180.0W²
 900x1200mm — 69.5 – 124.0W¹ | 240.0W²
 1200x1200mm — 92.5 – 165.0W¹ | 320.0W²

CRI: CRI>90

CCT: 3000K | 4000K | 2700-6500K

dimming optional: DALI | switchDIM | AQsmart

¹ adjustable power is available for CCT 3000K and 4000K
² Tunable-White (2700-6500K) has power always set for M and requires DALI or AQsmart control

equilibra

Designed in collaboration with Piotr Jagiellovicz Design



Perfectly refined shape of the equilibra collection is a real feast for the eyes. Balanced proportions and well-thought-out curves, especially beautifully presented in a glossy finishes, will add glamour to any space. Thanks to the different sizes and powers, the equilibra will work well as aesthetic general lighting for a home living room as well as large, spacious rooms. It successfully lights up communication routes, dining rooms or resting areas. A truly functional decoration for any interior.

Dopieszczony w każdym calu kształt kolekcji equilibra to prawdziwa uczta dla wzroku. Wyważone proporcje i dopracowane zaokrąglenia, szczególnie pięknie prezentujące się w połyskliwych wykończeniach, dodadzą uroku każdej przestrzeni. Dzięki różnicowym gabarytom i mocom, equilibra równie dobrze sprawdzi się jako estetyczne oświetlenie ogólne domowego salonu jak i dużych, przestronnych pomieszczeń. Z powodzeniem rozświetla ciągi komunikacyjne, jadalnie czy miejsca odpoczynku. Prawdziwie funkcjonalna ozdoba dla każdego wnętrza.



function

luminaire family

 [p.204](#)

 [p.338](#)

standard type

equilibra DIRECT LED surface

aqform.com/EQ0032

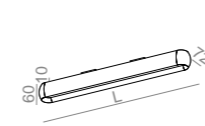

CRI>90 | 3000K | non dim

length	power	flux	cat. no
360mm	8.5W	1210lm	40052-M930-D9-00-__
640mm	17.5W	2430lm	40053-M930-D9-00-__
920mm	26.0W	3640lm	40054-M930-D9-00-__
1200mm	35.0W	4860lm	40055-M930-D9-00-__
1480mm	43.5W	6070lm	40056-M930-D9-00-__

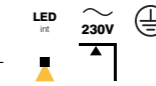

equilibra SOFT LED surface

aqform.com/EQ0022

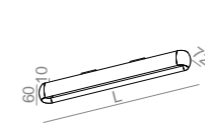

CRI>90 | 3000K | non dim

length	power	flux	cat. no
360mm	9.0W	1000lm	40040-M930-D0-00-__
640mm	18.5W	2010lm	40041-M930-D0-00-__
920mm	27.5W	3020lm	40042-M930-D0-00-__
1200mm	37.0W	4030lm	40043-M930-D0-00-__
1480mm	46.0W	5040lm	40044-M930-D0-00-__



finishes

standard matt structure



additional



additional gloss

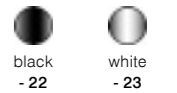

all versions

Configure your product using the fold-out or our website.

LED integrated

power:¹

equilibra DIRECT LED surface
 360mm — 4.5W | 8.5W
 640mm — 9.0W | 17.5W
 920mm — 13.0W | 26.0W
 1200mm — 17.5W | 35.0W
 1480mm — 22.0W | 43.5W

CRI: CRI>90

CCT:

2700K | 3000K | 4000K —
 equilibra DIRECT LED surface
 3000K | 4000K —
 equilibra SOFT LED surface

¹ all power versions for equilibra SOFT are shown in standard product tables

LENS LINE

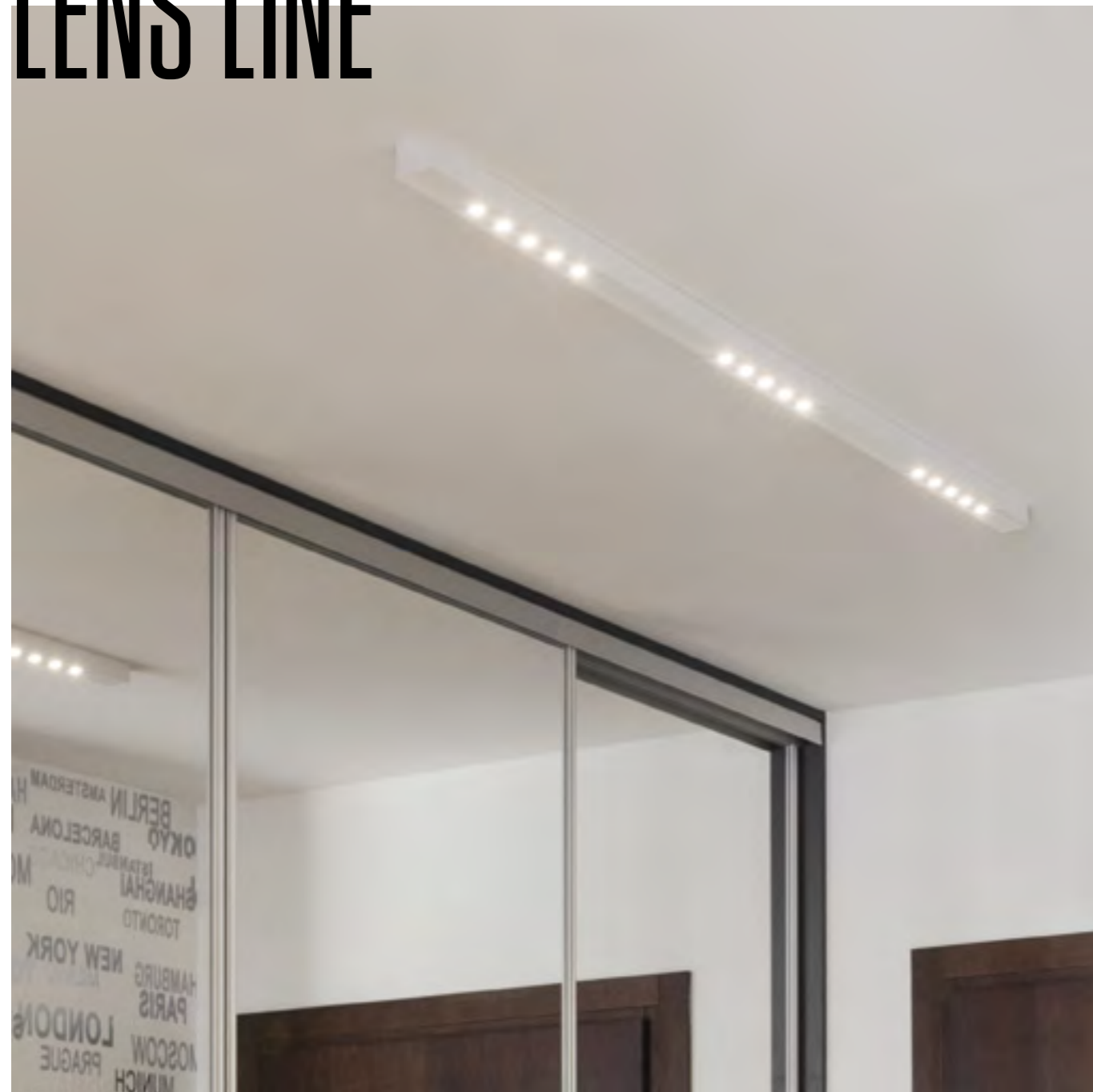

Straight lines of LENS LINE with spot light are somewhat hypnotizing. Small lenses rhythmically placed along the luminaire emit light comfortable for the eye, thanks to the reduced glare optics. Thanks to them, LENS LINE has its mesmerizing charm. This collection is perfect for both private and commercial interiors. It is worth remembering that expressive, linear elements will add character to any space.

Prostokątne linie LENS LINE z punktowym światłem mają w sobie coś hipnotyzującego. Dzięki optyce o zredukowanym olśnieniu niewielkie soczewki, rytmicznie rozmieszczone wzdłuż oprawy, emitują komfortowe dla oka światło. To im LENS LINE zawdzięcza swój hipnotyzujący urok. Ta kolekcja znakomicie sprawdza się zarówno w wnętrzach prywatnych, jak i tych o charakterze komercyjnym. Warto pamiętać, że wyraziste, liniowe elementy dodadzą charakteru każdej przestrzeni.



function

luminaire family

--- [p.082](#)

— [p.208](#)

└ [p.402](#)

standard type

LENS LINE 53 LED surface

aqform.com/LL0014

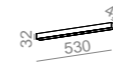

CRI>90 | 3000K | 54° | non dim

power	flux	cat. no
7.5W	760lm	40258-M930-W3-00-__



AQsmart LENS LINE LED section surface

aqform.com/LL0614

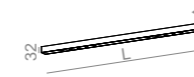

CRI>90 | 3000K | 54° | non dim

length	power	flux	cat. no
960mm	14.5W	1530lm	40260-M930-W3-00-__
1490mm	22.0W	2290lm	40262-M930-W3-00-__
2020mm	29.0W	3060lm	40264-M930-W3-00-__

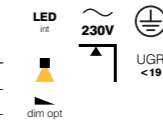

AQsmart LENS LINE 180x89 RC LED surface

aqform.com/LL3014



CRI>90 | 3000K | 54° | non dim

power	flux	cat. no
14.0W	1630lm	40292-L930-W3-00-__
29.0W	3060lm	40292-M930-W3-00-__

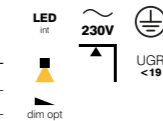

AQsmart LENS LINE 89x89 SQ LED surface

aqform.com/LL5014

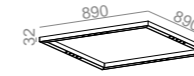

CRI>90 | 3000K | 54° | non dim

power	flux	cat. no
14.0W	1630lm	40293-L930-W3-00-__
29.0W	3060lm	40293-M930-W3-00-__

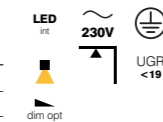

finishes

standard matt structure



additional

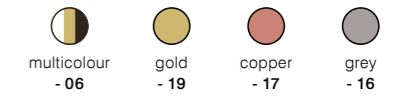

all versions

Configure your product using the fold-out or our website.

LED integrated

power:¹

LENS LINE LED section surface

960mm — 7.0W | 14.5W

1490mm — 10.5W | 22.0W

2020mm — 14.0W | 29.0W

CRI: CRI>90

CCT: 2700 | 3000K | 4000K

beam angle: 26° | 54°

dimming optional:

DALI | switchDIM | AQsmart —

LENS LINE LED section surface

LENS LINE 180x89 RC LED surface

LENS LINE 89x89 SQ LED surface

¹ all power versions for LENS LINE 180x89 RC and LENS LINE 89x89 SQ are shown in standard product tables

MIXLINE

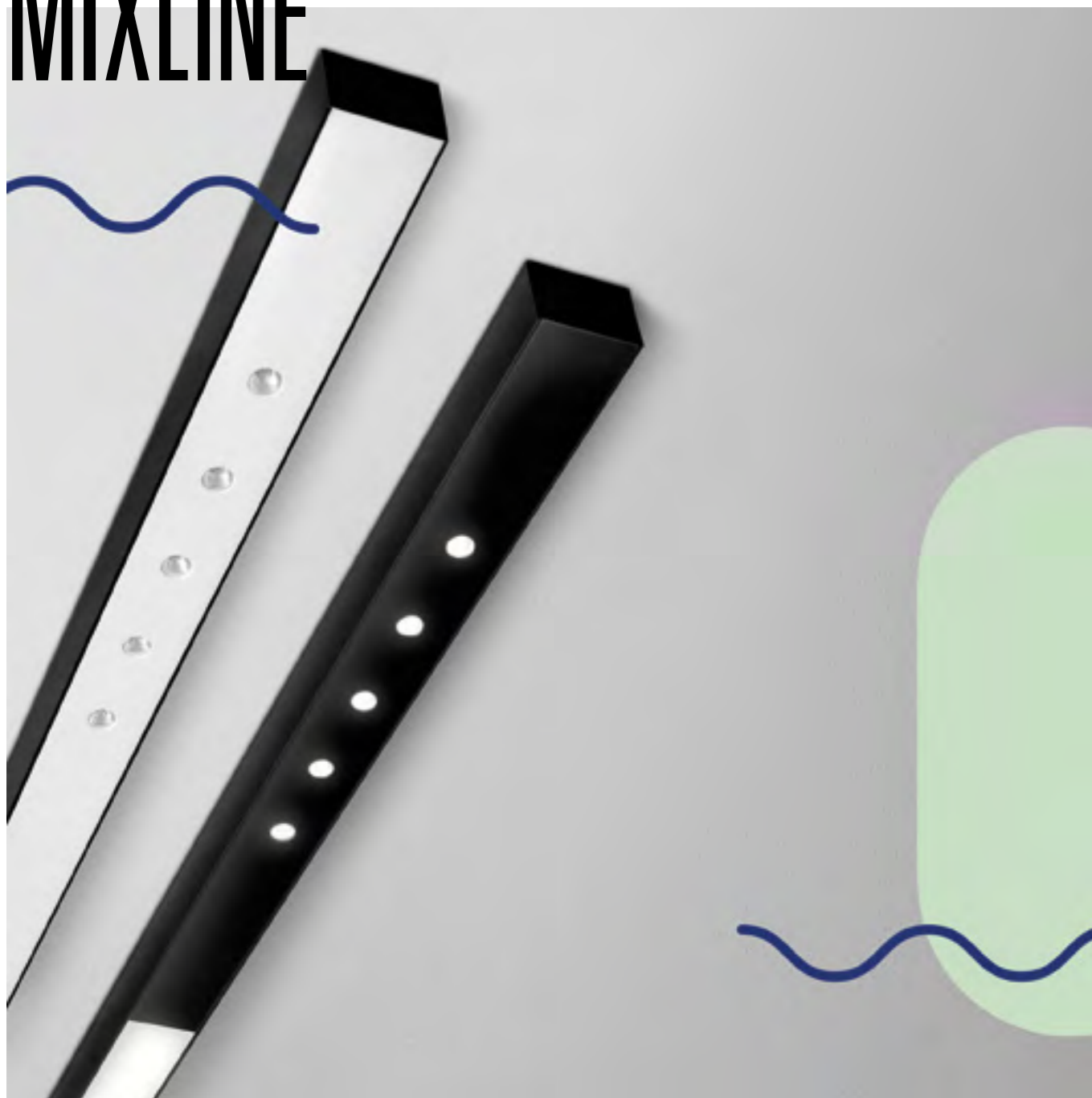



In a neat line with only 32x42mm size, MIXLINE combines two types of optics: diffused and spot light. This makes it an ideal proposition wherever a combination of general and task lighting is needed. Due to its elegant form and comfortable light, MIXLINE is often present in rest areas such as the living room or dining room. Thanks to the linear disposition, it also works as lighting for rectangular surfaces, such as desks, tables and communication zones. Comfort combined with minimalist aesthetics fits in many places.

W zgrabnej linii o przekroju zaledwie 32x42mm MIXLINE łączy dwa rodzaje optyki: światło rozproszone i punktowe. Dzięki temu stanowi idealną propozycję wszędzie tam, gdzie jest potrzebne połączenie oświetlenia ogólnego i zadaniowego. Ze względu na swą elegancką formę i komfortowe światło, MIXLINE często gości w przestrzeniach wypoczynku takich jak salon czy jadalnia. Dzięki liniowej dyspozycji sprawdza się też jako oświetlenie prostokątnych powierzchni, jak choćby biurka, stoły czy ciągi komunikacyjne. Komfort idący w parze z minimalistyczną estetyką odnajduje się w wielu miejscach.



luminaire family

-  [p.082](#)
-  [p.210](#)
-  [p.402](#)

standard type

AQsmart **MIXLINE LED surface** aqform.com/MX0014

CRI>90 | 3000K | 54° | non dim

length	power	flux	cat. no
1600mm	15.5W	2030lm	40286-M930-W3-00-__
1880mm	24.5W	3240lm	40287-M930-W3-00-__
2160mm	33.0W	4460lm	40288-M930-W3-00-__

LED int 230V dim opt

AQsmart **MIXLINE INV LED surface** aqform.com/MX1014

CRI>90 | 3000K | 54° | non dim

length	power	flux	cat. no
1670mm	21.0W	2830lm	40289-M930-W3-00-__
1920mm	24.5W	3240lm	40290-M930-W3-00-__

LED int 230V dim opt

AQsmart **MIXLINE 120x89 RT LED surface** aqform.com/MX2014

CRI>90 | 3000K | 54° | non dim

power	flux	cat. no
42.0W	5670lm	40291-M930-W3-00-__

LED int 230V dim opt

How covers and lenses are placed

MIXLINE 160 LED surface

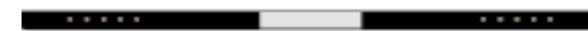

MIXLINE 188 LED surface

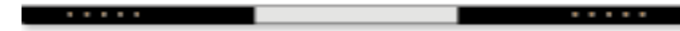

MIXLINE 216 LED surface



MIXLINE 167 INV LED surface



MIXLINE 192 INV LED surface



finishes

standard matt structure



additional



all versions

Configure your product using the fold-out or our website.

LED integrated

power: dependent on version

CRI: CRI>90

CCT: 2700 | 3000K | 4000K

beam angle: 26° | 54°

dimming optional: DALI | switchDIM | AQsmart





SET RAW mini







Neat, yet extremely efficient – this is how SET RAW mini can be described in brief. This is one of the luminaires that definitely should not be judged by its small dimensions alone. A single luminaire with a 32x42mm in diameter (less than the size of a matchbox) and a length of 153cm can effectively light up a large table or reception desk. The combination of efficiency with minimalist aesthetics opens up a wide range of possibilities for the SET RAW mini collection. As a result, fixtures from this family will easily find themselves in both home and commercial interiors, such as offices, conference rooms and restaurants.

Zgrabny, a przy tym niezwykle wydajny – tak w skrócie można opisać SET RAW mini. To jedna z opraw, których zdecydowanie nie należy oceniać tylko na podstawie niewielkich wymiarów. Pojedynczą oprawą o przekroju 32x42mm (to mniej niż rozmiar pudełka zapalek) i długości 153cm można efektywnie oświetlić duży stół lub ladę recepcji. Połączenie efektywności z minimalistyczną estetyką otwiera szeroki wachlarz możliwości dla kolekcji SET RAW mini. Dzięki temu oprawy z tej rodziny łatwo odnajdą się zarówno we wnętrzach domowych, jak i komercyjnych, takich jak biura, sale konferencyjne czy restauracje.



luminaire family

-  [p.086](#)
-  [p.376](#)
-  [p.214](#)
-  [p.414](#)
-  [p.302](#)

standard type

SET RAW mini LED surface

aqform.com/SR1014

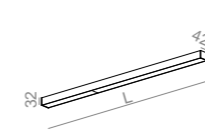

CRI>90 | 3000K | non dim

length	power	flux	cat. no
1250mm	13.0W	1820lm	40370-L930-D9-00-__
1530mm	17.5W	2430lm	40371-L930-D9-00-__
1810mm	22.0W	3040lm	40372-L930-D9-00-__
2090mm	26.5W	3640lm	40373-L930-D9-00-__



finishes

standard matt structure



additional



additional gloss



all versions

Configure your product using the fold-out or our website.

LED integrated

power:

1250mm — 13.0W | 26.0W
 1530mm — 17.5W | 35.0W
 1810mm — 22.0W | 43.5W
 2090mm — 26.5W | 52.0W

CRI: CRI>90

CCT: 2700 | 3000K | 4000K

dimming optional: DALI | switchDIM

RAFTER







Who likes to strain eyes while working in insufficient or too bright light? Rather no one. That is why it is worth ensuring visual comfort. Glare is the unpleasant feeling, and one of the effective ways to deal with it is to increase the shielding angle obtained by recessing the light source into the fixture like in RAFTER points. Precise optics and a large shielding angle guarantee high illuminance with extremely low glare. Proper optics combined with good light quality (high CRI, low flicker) will guarantee proper visual comfort.

Kto lubi wyciągać wzrok podczas pracy przy niewystarczającym lub zbyt jaskrawym świetle? Raczej nikt. Dlatego warto zadbać o komfort wizualny. Nieprzyjemne odczucia powoduje olśnienie, a jednym ze skutecznych sposobów radzenia sobie z nim jest powiększenie kąta ochrony przez zagłębienie źródła światła w oprawie – jak w RAFTER points. Precyzyjna optyka i duży kąt ochrony gwarantują wysokie natężenie światła przy niezwykle niskim olśnieniu. Odpowiednia optyka połączona z dobrą jakością światła (wysokie CRI, niskie tętnienie) zagwarantuje właściwy komfort wizualny.



luminaire family

-  [p.094](#)
-  [p.216](#)
-  [p.268](#)
-  [p.336](#)
-  [p.422](#)

standard type

AQsmart

RAFTER LED surface

aqform.com/RA0014

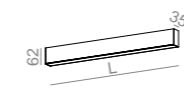

CRI>90 | 3000K | non dim

length	power	flux	cat. no
570mm	17.5W	2430lm	40529-M930-D9-00-__
860mm	26.0W	3640lm	40530-M930-D9-00-__
1140mm	35.0W	4860lm	40531-M930-D9-00-__
1420mm	43.5W	6070lm	40532-M930-D9-00-__
1700mm	52.0W	7290lm	40533-M930-D9-00-__

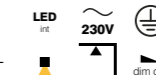

AQsmart

RAFTER points LED surface

aqform.com/RA1014

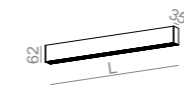

CRI>90 | 3000K | 50° | non dim

length	power	flux	cat. no
270mm	10.0W	1230lm	40525-L930-W1-00-__
540mm	19.5W	2470lm	40526-L930-W1-00-__

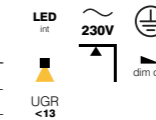

AQsmart

RAFTER points LED section surface

aqform.com/RA1614



CRI>90 | 3000K | 50° | non dim

length	power	flux	cat. no
540mm	10.0W	1230lm	40520-L930-W1-00-__
940mm	15.0W	1850lm	40521-L930-W1-00-__
1330mm	19.5W	2470lm	40522-L930-W1-00-__
1730mm	24.5W	3090lm	40523-L930-W1-00-__
2130mm	29.5W	3700lm	40524-L930-W1-00-__

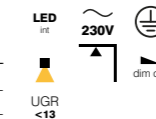

How lenses are placed in RAFTER points LED section

RAFTER points 54 LED section surface



RAFTER points 94 LED section surface



RAFTER points 133 LED section surface



RAFTER points 173 LED section surface



RAFTER points 213 LED section surface



finishes

standard matt structure



additional



additional gloss



all versions

Configure your product using the fold-out or our website.

LED integrated

power:

RAFTER LED surface

- 570mm — 9.0W | 17.5W | 25.0W
- 860mm — 13.0W | 26.0W | 37.5W
- 1140mm — 17.5W | 35.0W | 50.0W
- 1420mm — 22.0W | 43.5W | 62.5W
- 1700mm — 26.5W | 52.0W | 75.0W

RAFTER points LED surface

19.5W | 41.0W

RAFTER points LED section surface

- 540mm — 10.0W | 20.5W
- 940mm — 15.0W | 31.0W
- 1330mm — 19.5W | 41.0W
- 1730mm — 24.5W | 51.5W

CRI: CRI>90

CCT: 2700 | 3000K | 4000K

beam angle:

37° | 50° —

RAFTER points LED surface

RAFTER points LED section surface

dimming optional:

DALI | switchDIM | AQsmart —

- RAFTER LED surface
- RAFTER points 54 LED surface
- RAFTER points 94 LED section surface
- RAFTER points 133 LED section surface
- RAFTER points 173 LED section surface
- RAFTER points 213 LED section surface

RAFTER mix



By combining several lighting functions in one form, RAFTER mix is one product, which can comprehensively brighten the space. The basis are points modules that increase the illuminance on the selected surface. Their precise light is directed downwards. They can be combined with PET mini modules or with a diffuser. PET mini modules are mounted on joints enabling movement and directing of light. Thanks to this, they can easily light up vertical surfaces. Moreover, the module with a cover can provide general light over a large area.

RAFTER mix, dzięki połączeniu w jednej formie kilku funkcji oświetleniowych, pozwala jednym produktem kompleksowo oświetlić przestrzeń. Podstawą są moduły points, które podnoszą natężenie oświetlenia nawybranej powierzchni. Ich precyzyjne światło skierowane jest w dół. Można je połączyć z modułami PET mini albo przesłoną rozpraszającą. Moduły PET mini są zamocowane na przegubach umożliwiających ruch i kierunkowanie światła. Dzięki temu mogą łatwo oświetlić powierzchnie pionowe. Z kolei moduł z przesłoną zapewni światło ogólne na dużej powierzchni.



luminaire family

--- [p.092](#)

standard type

RAFTER mix 57 LED surface

aqform.com/RA9014

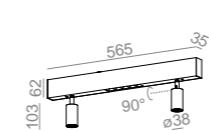

CRI>90 | 3000K | 50° | non dim

power flux

cat. no

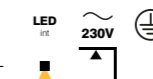

11.0W 1390lm 46910-M930-W1-00-__

AQsmart RAFTER mix 94 LED surface

aqform.com/RA9014



CRI>90 | 3000K | 50° | non dim

power flux

cat. no

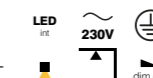

21.0W 2620lm 46911-M930-W1-00-__

AQsmart RAFTER mix 133 LED surface

aqform.com/RA9014

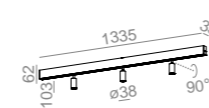

CRI>90 | 3000K | 50° | non dim

power flux

cat. no

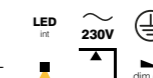

29.0W 3630lm 46912-M930-W1-00-__

AQsmart RAFTER mix 136 LED surface

aqform.com/RA9014

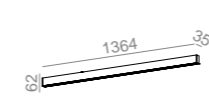

CRI>90 | 3000K | 50° | non dim

power flux

cat. no

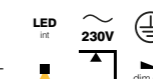

32.5W 4090lm 46913-M930-W1-00-__

finishes

standard matt structure

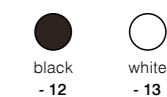

additional

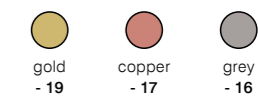

all versions

Configure your product using the fold-out or our website.

LED integrated

power: dependent on version
 CRI: CRI>90
 CCT: 2700 | 3000K | 4000K
 beam angle: 37° | 50°
 dimming optional:
 DALI | switchDIM | AQsmart —
 RAFTER mix 94 LED surface
 RAFTER mix 133 LED surface
 RAFTER mix 136 LED surface



project: Madama / Awangarda, Warszawa | design: Madama | photo: Yassen Heistov

SET TRU



Kraków | lighting design: Light Project4U Joanna Raszewska-Sztorc





The minimalist in form TRU family offers extensive configuration options for light parameters. We can choose from: seven lengths, two power versions, three control variants (including wireless AQsmart), three colour temperatures and two covers: standard and microprismatic, which limits glare. This gives over 220 standard TRU configurations without even mentioning colour variants. As you can see, these luminaires can be easily selected for specific needs. Regardless of whether it is lighting the office, hallway, living room, dining room or large interior – TRU will always adapt.

Oszczędna w formie rodzina TRU daje szerokie możliwości konfiguracji parametrów światła. Do wyboru mamy: siedem długości, dwie wersje mocy, trzy warianty sterowania (w tym bezprzewodowy AQsmart), trzy temperatury barwowe i dwie przesłony: standardowa i mikropryzmatyczna, ograniczająca oślnienie. To daje ponad 220 standardowych konfiguracji TRU i to jeszcze bez wzięcia pod uwagę wariantów kolorystycznych. Jak zatem widać, oprawy te można łatwo dobrać do konkretnych potrzeb. Niezależnie czy chodzi o oświetlenie biura, korytarza, salonu, jadalni czy wielkogabarytowego wnętrza – TRU zawsze się dopasuje.



function

luminaire family

-  [p.098](#)
-  [p.332](#)
-  [p.218](#)
-  [p.378](#)
-  [p.272](#)
-  [p.416](#)

standard type

AQsmart

SET TRU LED surface

aqform.com/BBO022

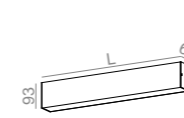

CRI>90 | 3000K | non dim

length	power	flux	cat. no
290mm	8.5W	1210lm	45942-M930-D9-00-__
570mm	17.5W	2430lm	45944-M930-D9-00-__
860mm	26.0W	3640lm	45948-M930-D9-00-__
1140mm	35.0W	4860lm	45950-M930-D9-00-__
1420mm	43.5W	6070lm	45952-M930-D9-00-__
1700mm	52.0W	7290lm	45954-M930-D9-00-__
1980mm	61.0W	8500lm	45956-M930-D9-00-__



AQsmart

SET TRU PRO LED surface

aqform.com/BBO022



CRI>90 | 3000K | non dim

length	power	flux	cat. no
290mm	8.5W	1210lm	46993-M930-D5-00-__
570mm	17.5W	2430lm	46992-M930-D5-00-__
860mm	26.0W	3640lm	46991-M930-D5-00-__
1140mm	35.0W	4860lm	46997-M930-D5-00-__
1420mm	43.5W	6070lm	46996-M930-D5-00-__
1700mm	52.0W	7290lm	46995-M930-D5-00-__
1980mm	61.0W	8500lm	46994-M930-D5-00-__

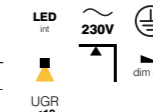

covers comparison



regular (opal)



PRO (microprism)

See PRO lighting effect on the website

finishes

standard matt structure

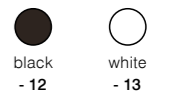

additional



additional gloss



all versions

Configure your product using the fold-out or our website.

LED integrated

power:

290mm — 4.5W | 8.5W
 570mm — 9.0W | 17.5W
 860mm — 13.0W | 26.0W
 1140mm — 17.5W | 35.0W
 1420mm — 22.0W | 43.5W
 1700mm — 26.5W | 52.0W
 1980mm — 31.0W | 61.0W

CRI: CRI>90

CCT: 2700 | 3000K | 4000K | 2700-6500K¹

dimming optional:

DALI | switchDIM | AQsmart
 from length 570mm



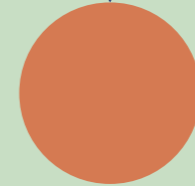
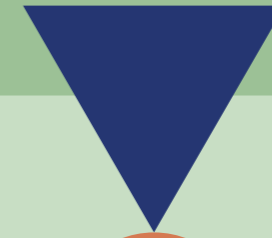



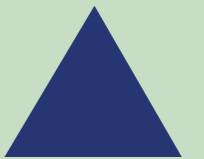





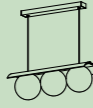
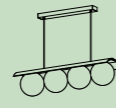
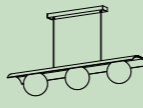
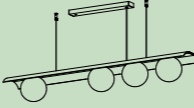
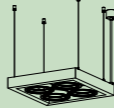
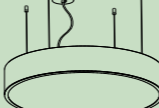
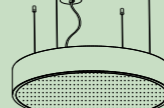
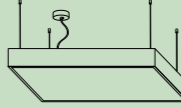
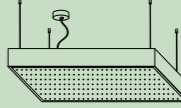
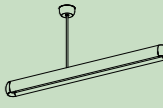





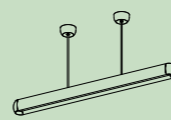
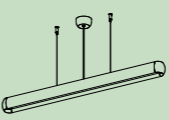
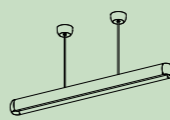
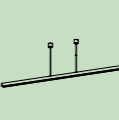
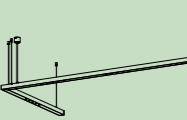
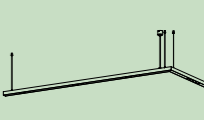



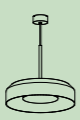

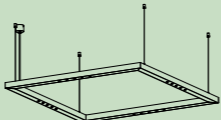
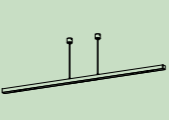
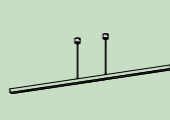
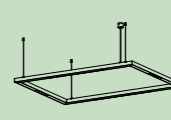
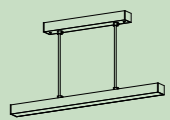
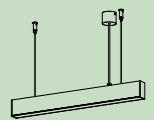
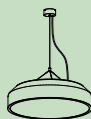
¹ 2700-6500K from length 1140mm



SUSPENDED

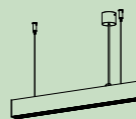
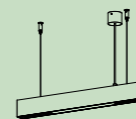
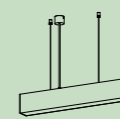
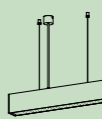
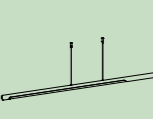
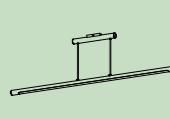

SUSPENDED

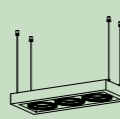
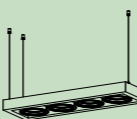
<p>MODERN BALL p. 170</p>  <p>new</p>	<p>MODERN BALL x2 p. 170</p>  <p>new</p>	<p>MODERN BALL x3 p. 170</p>  <p>new</p>	<p>MODERN BALL x4 p. 170</p>  <p>new</p>	<p>MODERN BALL x3 section p. 170</p>  <p>new</p>	<p>MODERN BALL x4 asymmetry p. 170</p>  <p>new</p>	<p>CADRA 111x4 SQ p. 198</p>  <p>new</p>	<p>BIG SIZE next round p. 200</p>  <p>new</p>	<p>BIG SIZE PRO next round p. 200</p>  <p>new</p>	<p>BIG SIZE next square p. 202</p>  <p>new</p>	<p>BIG SIZE PRO next square p. 202</p>  <p>new</p>	<p>equilibra BALANS p. 204</p>  <p>new</p>
<p>PET next mini p. 174</p>  <p>new</p>	<p>PET next p. 174</p>  <p>new</p>	<p>PET next maxi p. 174</p>  <p>new</p>	<p>PET zoom p. 174</p>  <p>new</p>	<p>PET p. 174</p>  <p>new</p>	<p>MODERN GLASS Flared p. 176</p>  <p>new</p>	<p>equilibra DIRECT p. 204</p>  <p>new</p>	<p>equilibra CENTRAL DIRECT p. 204</p>  <p>new</p>	<p>equilibra SOFT p. 204</p>  <p>new</p>	<p>LENS LINE section p. 208</p>  <p>new</p>	<p>LENS LINE 180x89 LC p. 208</p>  <p>new</p>	<p>LENS LINE 180x89 RC p. 208</p>  <p>new</p>
<p>MODERN GLASS Barrel p. 178</p>  <p>new</p>	<p>MODERN GLASS Tube p. 178</p>  <p>new</p>	<p>MORPH Flared p. 182</p>  <p>new</p>	<p>REVEL dot p. 184</p>  <p>new</p>	<p>MAXI RING dot p. 184</p>  <p>new</p>	<p>REVEL p. 184</p>  <p>new</p>	<p>LENS LINE 89x89 SQ p. 208</p>  <p>new</p>	<p>MIXLINE p. 210</p>  <p>new</p>	<p>MIXLINE INV p. 210</p>  <p>new</p>	<p>MIXLINE 120x89 RT p. 210</p>  <p>new</p>	<p>SET RAW mini p. 214</p>  <p>new</p>	<p>RAFTER p. 216</p>  <p>new</p>
<p>MAXI RING p. 184</p>  <p>new</p>	<p>GLOB simple p. 188</p>  <p>new</p>	<p>KARI p. 190</p>  <p>new</p>	<p>TUBA 111 ORLED p. 192</p>  <p>new</p>	<p>TUBA 111 p. 192</p>  <p>new</p>	<p>QUPET mini p. 196</p>  <p>new</p>	<p>RAFTER points p. 216</p>  <p>new</p>	<p>RAFTER points section p. 216</p>  <p>new</p>	<p>SET TRU p. 218</p>  <p>new</p>	<p>SET TRU PRO p. 218</p>  <p>new</p>	<p>THIN TUBE asymmetry p. 222</p>  <p>new</p>	<p>THIN TUBE central p. 222</p>  <p>new</p>
<p>QUPET 12 p. 196</p>  <p>new</p>	<p>QUPET p. 196</p>  <p>new</p>	<p>CADRA 111x1 p. 198</p>  <p>new</p>	<p>CADRA 111x2 p. 198</p>  <p>new</p>	<p>CADRA 111x3 p. 198</p>  <p>new</p>	<p>CADRA 111x4 p. 198</p>  <p>new</p>						

MODERN BALL

Designed in collaboration with DECHEM

new



Do you need another BALL compositions? Contact us.¹

DECHEM and AQForm collaboration once again resulted in merging most traditional luminaire material with the state of the art lighting technology. Symmetrical composition of glass balls emitting soft light, complements any stylish interior. Moon resembling MODERN BALL fuses aesthetics with high efficiency and visual comfort. Milk-glass gently diffuses light and protects the observer's eye from an unpleasant glare. MODERN BALL luminaires can be used both as general lighting and mood lighting.

Współpraca studia DECHEM i AQForm pozwoliła po raz kolejny połączyć najbardziej tradycyjny dla oświetlenia materiał z wiodącą technologią. Kompozycja symetrycznie ułożonych szklanych kul, emitujących miękkie światło, stanowi doskonałe uzupełnienie każdej stylowej aranżacji. Przypominająca kształtem księżyc, oprawa MODERN BALL łączy funkcję ozdobną z wysoką efektywnością i komfortem wizualnym. Mleczne szkło delikatnie rozpraszają światło i chroni wzrok obserwatora przed przykrym olśnieniem. Oprawy MODERN BALL mogą służyć zarówno jako oświetlenie ogólne, jak i nastrojowe oświetlenie uzupełniające.



function

luminaire family

— p.104

— p.288

standard type

MODERN BALL WP LED suspended

aqform.com/MB1015

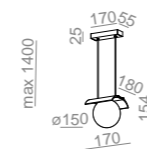

CRI>90 | 3000K | non dim

power	flux	cat. no
6.0W	880lm	59777-L930-D0-00-__
9.0W	1200lm	59777-M930-D0-00-__

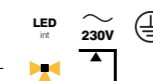

MODERN BALL WP x2 LED suspended

aqform.com/MB2015

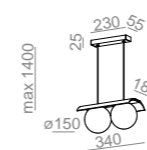

CRI>90 | 3000K | non dim

power	flux	cat. no
12.5W	1770lm	59778-L930-D0-00-__
18.0W	2410lm	59778-M930-D0-00-__

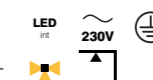

MODERN BALL WP x3 LED suspended

aqform.com/MB3015

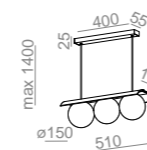

CRI>90 | 3000K | non dim

power	flux	cat. no
18.5W	2660lm	59779-L930-D0-00-__
26.5W	3620lm	59779-M930-D0-00-__

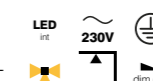

MODERN BALL WP x4 LED suspended

aqform.com/MB4015

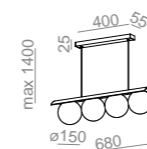

CRI>90 | 3000K | non dim

power	flux	cat. no
25.0W	3550lm	59780-L930-D0-00-__
35.5W	4830lm	59780-M930-D0-00-__

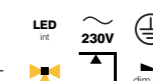

MODERN BALL WP x3 LED section suspended

aqform.com/MB3615

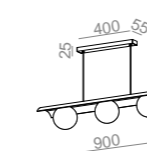

CRI>90 | 3000K | non dim

power	flux	cat. no
18.5W	2660lm	59822-L930-D0-00-__
26.5W	3620lm	59822-M930-D0-00-__

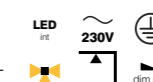

MODERN BALL WP x4 LED asymmetry suspended

aqform.com/MB4415

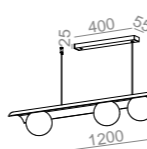

CRI>90 | 3000K | non dim

power	flux	cat. no
25.0W	3550lm	59823-L930-D0-00-__
35.5W	4830lm	59823-M930-D0-00-__

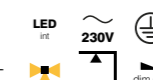

finishes

standard matt structure

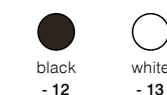

additional



all versions

Configure your product using the fold-out or our website.

LED integrated

power: dependent on version

CRI: CRI>90

CCT: 2700K | 3000K | 4000K

dimming optional:

DALI —

MODERN BALL WP x3 LED suspended

MODERN BALL WP x4 LED suspended

MODERN BALL WP x3 LED section suspended

MODERN BALL WP x4 LED asymmetry suspended



PET



The minimalism of PET collection makes it able to fit into any space. Thanks to a wide range of technical parameters, height of the room is hardly any limit. The 'next' series, thanks to its hybrid optics and increased protection angle, guarantees high visual comfort. Zoom version with a glass lens allows for an easy change of a beam angle, before or after installation. Especially for traditionalists PET is also available with a retrofit lamp.

Kolekcja PET charakteryzuje się minimalistycznym wzornictwem, które doskonale podkreśla styl wnętrza. Dzięki zróżnicowanym parametrom, oprawy te świetnie sprawdzą się zarówno w wysokich, jak i niskich przestrzeniach. Seria „next”, dzięki hybrydowej optyce i podwyższonemu kątowni ochrony, gwarantuje wysoki komfort wizualny. Wersja zoom ze szklaną soczewką pozwala łatwo zmieniać kąt świecenia, nawet po zamocowaniu oprawy. Z kolei dla sympatyków bardziej tradycyjnych rozwiązań, dostępna jest także oprawa na wymienne źródło światła.



luminaire family

-  [p.106](#)  [p.362](#)
-  [p.228 / 230 / 232](#)
-  [p.392](#)

standard type

NEW PET next mini LED suspended aqform.com/PE1815

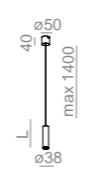

CRI>90 | 3000K | 36° | non dim

length	power	flux	cat. no
120mm	4.5W	520lm	59768-M930-F1-00-__
200mm	4.5W	520lm	59769-M930-F1-00-__
320mm	4.5W	520lm	59770-M930-F1-00-__

LED int 230V UGR <19

QS Q4 2020 black
QS Q4 2020 white

NEW PET next LED suspended aqform.com/PE0815

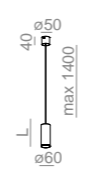

CRI>90 | 3000K | 35° | non dim

length	power	flux	cat. no
120mm	8.5W	1170lm	59771-M930-F1-00-__
200mm	8.5W	1170lm	59772-M930-F1-00-__
320mm	8.5W	1170lm	59773-M930-F1-00-__

LED int 230V UGR <19 dim opt

NEW PET next maxi LED suspended aqform.com/PE2815

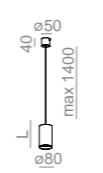

CRI>90 | 3000K | 32° | non dim

length	power	flux	cat. no
120mm	17.0W	2330lm	59774-M930-F1-00-__
200mm	17.0W	2330lm	59775-M930-F1-00-__
320mm	17.0W	2330lm	59776-M930-F1-00-__

LED int 230V UGR <19 dim opt

11.5W — available additional power

PET zoom LED 230V suspended aqform.com/PE2075

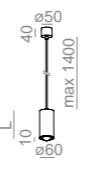

CRI>90 | 3000K | 20-41° | Phase-Control

length	power	flux	cat. no
120mm	8.0W	620lm	59759-M930-Z3-PH-__
170mm	8.0W	620lm	59760-M930-Z3-PH-__
250mm	8.0W	620lm	59761-M930-Z3-PH-__
500mm	8.0W	620lm	50589-M930-Z3-PH-__

LED int 230V UGR <19 dim

PET suspended aqform.com/PE9035

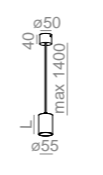

PAR16, 230V | GU10 | Phase-Control

length	power	cat. no
90mm	max: LED 8.0W	54211-0000-U8-PH-__
170mm	max: LED 8.0W	50565-0000-U8-PH-__
250mm	max: LED 8.0W	50566-0000-U8-PH-__
500mm	max: LED 8.0W	50588-0000-U8-PH-__

LED int 230V UGR <19 dim > 0.5 m

finishes

standard matt structure

black - 12 white - 13

additional

multicolour - 06 gold - 19 copper - 17 grey - 16

additional gloss

for:
PET zoom LED 230V suspended black - 22 white - 23
PET suspended

additional white-black

for:
PET next mini LED suspended white-black - 46
PET next LED suspended
PET next maxi LED suspended

all versions

Configure your product using the fold-out or our website.

LED integrated

power: dependent on version
CRI: CRI>90
CCT: 2700K | 3000K | 4000K
beam angle:
20° | 36° — PET next mini LED suspended
18° | 35° — PET next LED suspended
19° | 32° — PET next maxi LED suspended

dimming optional:

DALI —
PET next 20 LED suspended
PET next 32 LED suspended
PET next maxi 20 LED suspended
PET next maxi 32 LED suspended

LED 230V integrated

power: 8.0W
CRI: CRI>90
CCT: 2700K | 3000K | 4000K
beam angle: 20-26-33-41°
dimming standard: Phase-Control

PAR16, 230V

power: max: LED 8.0W
dimming standard: Phase-Control
light source not included

MODERN GLASS

Designed in collaboration with DECHEM



MODERN GLASS in an effect of collaboration between AQForm and a Czech DECHEM studio. It is a perfect composition of finesse minimalism, craftsmanship and efficient technology. All three sum up in a glass form, that would add unique character to any interior. Creating an intimate, pleasant atmosphere was never this easy. Handmade, transparent shades make every single luminaire unique, while variety of shapes and colour finishes would match any taste. Using spider system, MODERN GLASS can be freely multiplied, no matter how many power sources you have.

MODERN GLASS to efekt współpracy z czeskim biurem projektowym DECHEM. Ta doskonała kompozycja łączy finezyjny minimalizm, artystyczne rzemiosło oraz efektywną technologię. Wszystko to zostało zamknięte w szklanej formie, nadającej niepowtarzalny charakter każdemu wnętrzu. Stworzenie przyjemnej atmosfery jeszcze nigdy nie było tak proste. Ręcznie robione klosze czynią każdą z opraw wyjątkową, a szeroki wybór kształtów, tekstur i kolorów sprosta najbardziej wymagającym gustom. MODERN GLASS to nietuzinkowa ozdoba, którą można także zastosować w formie spider, łącząc kilka opraw przy jednym punkcie zasilającym.



luminaire family

- [p.110](#)
- [p.392](#)
- [p.292](#)
- [p.352](#)

standard type

glass finishes Flared



glass finishes Barrel



glass finishes Tube



MODERN GLASS Flared LED 230V suspended

aqform.com/MG2015



CRI>90 | 3000K | Phase-Control

glass	power	flux	cat. no
TP	6.0W	500lm	50477-M930-D9-PH-__
SP	6.0W	500lm	50536-M930-D9-PH-__
WP	6.0W	500lm	59729-M930-D9-PH-__
TR	6.0W	500lm	50486-M930-D9-PH-__

LED int.230V, 230V, dim, >0.5m

MODERN GLASS Flared E27 suspended

aqform.com/MG2025

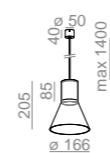

Standard | E27 | Phase-Control

glass	power	cat. no
TP	max: LED 13.0W	50474-0000-U8-PH-__
SP	max: LED 13.0W	50533-0000-U8-PH-__
WP	max: LED 13.0W	59726-0000-U8-PH-__
TR	max: LED 13.0W	50483-0000-U8-PH-__

LED int.230V, 230V, dim, >0.5m

QS SP glass, black
QS TP glass, white

MODERN GLASS Flared GU10 suspended

aqform.com/MG2035

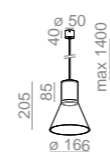

PAR16, 230V | GU10 | Phase-Control

glass	power	cat. no
TP	max: LED 8.0W	50471-0000-U8-PH-__
SP	max: LED 8.0W	50530-0000-U8-PH-__
WP	max: LED 8.0W	59723-0000-U8-PH-__
TR	max: LED 8.0W	50480-0000-U8-PH-__

PAR16, 230V, dim, >0.5m

finishes

- standard** matt structure
QS from 01.2021
- black - 12
 - white - 13
- additional**
- gold - 19
 - copper - 17
 - grey - 16

all versions

Configure your product using the fold-out or our website.

LED 230V integrated

power: 6.0W
CRI: CRI>90
CCT: 2700K | 3000K | 4000K
dimming standard: Phase-Control

Standard E27

power: max: LED 13.0W
dimming standard: Phase-Control
light source not included

PAR16, 230V

power: max: LED 8.0W
dimming standard: Phase-Control
light source not included

standard type

MODERN GLASS Barrel LED 230V suspended

aqform.com/MG1015

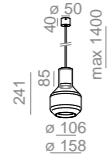

CRI>90 | 3000K | Phase-Control

glass	power	flux	cat. no
TP	6.0W	500lm	50478-M930-D9-PH-__
SP	6.0W	500lm	50537-M930-D9-PH-__
WP	6.0W	500lm	59730-M930-D9-PH-__
TR	6.0W	500lm	50487-M930-D9-PH-__

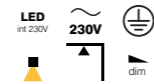

MODERN GLASS Barrel E27 suspended

aqform.com/MG1025

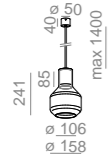

Standard | E27 | Phase-Control

glass	power	cat. no
TP	max: LED 13.0W QS	50475-0000-U8-PH-__
SP	max: LED 13.0W QS	50534-0000-U8-PH-__
WP	max: LED 13.0W	59727-0000-U8-PH-__
TR	max: LED 13.0W	50484-0000-U8-PH-__

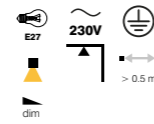

QS SP glass, black
QS TP glass, white

MODERN GLASS Barrel GU10 suspended

aqform.com/MG1035

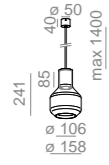

PAR16, 230V | GU10 | Phase-Control

glass	power	cat. no
TP	max: LED 8.0W	50472-0000-U8-PH-__
SP	max: LED 8.0W	50531-0000-U8-PH-__
WP	max: LED 8.0W	59722-0000-U8-PH-__
TR	max: LED 8.0W	50481-0000-U8-PH-__

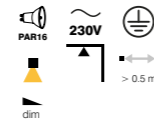

MODERN GLASS Tube LED 230V suspended

aqform.com/MG3015

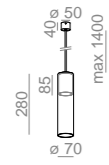

CRI>90 | 3000K | Phase-Control

glass	power	flux	cat. no
TP	6.0W	500lm	50476-M930-D9-PH-__
SP	6.0W	500lm	50535-M930-D9-PH-__
WP	6.0W	500lm	59728-M930-D9-PH-__
TR	6.0W	500lm	50485-M930-D9-PH-__



MODERN GLASS Tube E27 suspended

aqform.com/MG3025

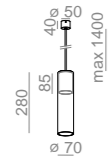

T30, 230V | E27 | Phase-Control

glass	power	cat. no
TP	max: LED 13.0W QS	50473-0000-U8-PH-__
SP	max: LED 13.0W QS	50532-0000-U8-PH-__
WP	max: LED 13.0W	59725-0000-U8-PH-__
TR	max: LED 13.0W	50482-0000-U8-PH-__

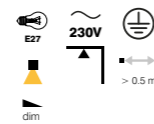

QS SP glass, black
QS TP glass, white

MODERN GLASS Tube GU10 suspended

aqform.com/MG3035

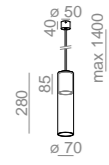

PAR16, 230V | GU10 | Phase-Control

glass	power	cat. no
TP	max: LED 8.0W	50470-0000-U8-PH-__
SP	max: LED 8.0W	50529-0000-U8-PH-__
WP	max: LED 8.0W	59724-0000-U8-PH-__
TR	max: LED 8.0W	50479-0000-U8-PH-__

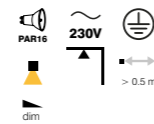

finishes

standard matt structure

QS from 01.2021

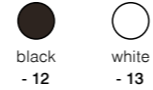

additional



all versions

Configure your product using the fold-out or go to website.

LED 230V integrated

power: dependent on version
CRI: CRI>90
CCT: 2700K | 3000K | 4000K
dimming standard: Phase-Control

Standard E27

power: max: LED 13.0W
dimming standard: Phase-Control
light source not included

PAR16, 230V

power: max: LED 8.0W
dimming standard: Phase-Control
light source not included



photo: Martin Chum

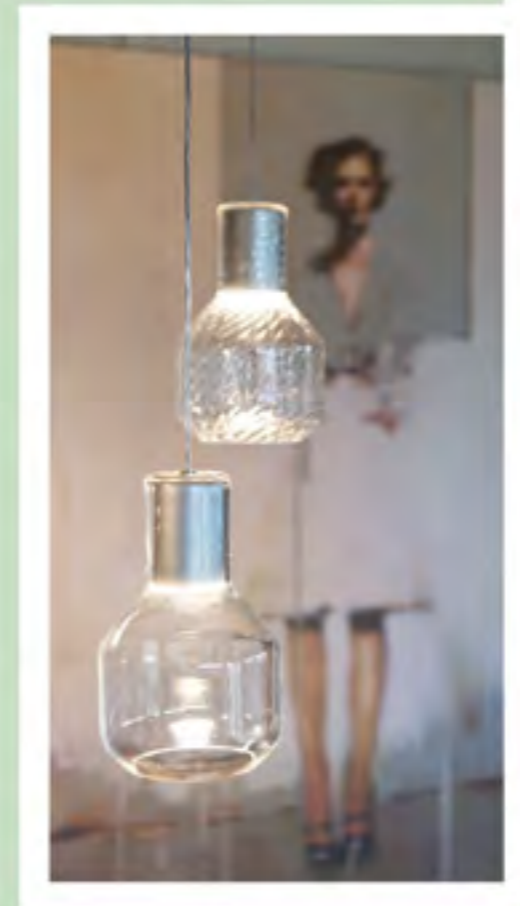

MORPH



MORPH is another proposition for all those who seek decorative look and proper technical parameters in one luminaire. Thanks to its optics, MORPH is a perfect solution for accenting tables and bars, providing excellent task lighting for both home dining rooms and restaurants. Thanks to gold or copper inside finish, light can be additionally warmed for an even more relaxing effect. This fashionable solution is suitable for residential interiors as well as restaurants or lobbies. Thanks to good colour rendering, every object worth noticing will not only be bright, but also full of colours.

Kolekcja MORPH to kolejna propozycja o dekoracyjnym charakterze i doskonałych parametrach technicznych. Dzięki optyce przeznaczonej do akcentowania, z powodzeniem doświetli każdy stół lub stolik, dodając uroku zarówno domowej jadalni, jak i restauracji. Dzięki możliwości wykończenia wnętrza oprawy w kolorze złotym lub miedzianym, można uzyskać delikatnie ocieplone, sprzyjające relaksowi światło. To modne rozwiązanie idealnie sprawdzi się w domach, ale także w restauracjach czy lobby. Dzięki dobremu odwzorowaniu barw, każdy element warty naszej uwagi będzie nie tylko jasny, ale również pełen kolorów.



standard type

MORPH Flared LED suspended

aqform.com/MHO215



CRI>90 | 3000K | 40° | non dim

power	flux	cat. no
7.5W	740lm	50576-M930-F3-00-__

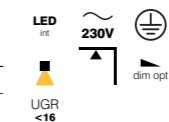

finishes

standard matt structure

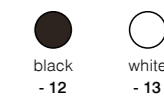

additional



all versions

Configure your product using the fold-out or our website.

LED integrated

power: 7.5W
 CRI: CRI>90
 CCT: 3000K | 4000K
 beam angle: 40°
 dimming optional: Phase-Control

REVEL / MAXI RING



MAXI RING and its smaller analogue REVEL are a family that can perfectly balance aesthetics and geometrical functionality. Reflecting light 'dot' versions, can easily create soft, decorative effect by providing relaxing atmosphere. Thanks to hiding light source from the observer's eye, glare is greatly reduced and visual comfort is high. Version with gold or copper interior is a great ally of rest and chillout. Version with cover offers higher power and luminous flux. It can easily deal with large interiors where high light intensity is required.

MAXI RING i jego mniejszy odpowiednik REVEL, to rodzina która doskonale łączy geometryczną funkcjonalność z estetyką. Wersje „dot” odbijające światło, dają miękką, dekoracyjny efekt, wprowadzając do wnętrza błogą atmosferę relaksacji. Zredukowane oświecenie, osiągnięte dzięki ukryciu źródła światła przed wzrokiem obserwatora, zwiększa nasz komfort wizualny. Szczególnie oprawy w wersji ze złotym lub miedzianym wnętrzem sprzyjają wyciszeniu. Z kolei wersja z przesłoną oferuje wyższe moce i strumienie świetlne – z łatwością rozświetli wnętrza, w których wymagane jest duże natężenie oświetlenia.



luminaire family

— p.076

— p.126

standard type



REVEL dot LED 230V suspended

aqform.com/RE1075

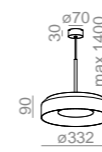

CRI>80 | 3000K | Phase-Control

power	flux	cat. no
20.5W	2230lm	50521-M830-D0-PH-__

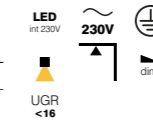

MAXI RING dot LED 230V suspended

aqform.com/MR1075

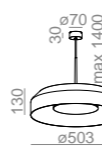

CRI>80 | 3000K | Phase-Control

power	flux	cat. no
30.5W	3500lm	50518-M830-D0-PH-__

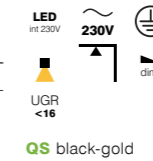

AQsmart

REVEL LED suspended

aqform.com/RE0015



CRI>90 | 3000K | non dim

power	flux	cat. no
8.5W	1270lm	50519-L930-D9-00-__
17.0W	2550lm	50519-M930-D9-00-__

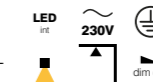

AQsmart

MAXI RING LED suspended

aqform.com/MR0015



CRI>90 | 3000K | non dim

power	flux	cat. no
14.5W	2230lm	59629-L930-D9-00-__
30.0W	4460lm	59629-M930-D9-00-__



finishes

standard matt structure



additional



additional multicolour

for:
REVEL dot LED 230V suspended
MAXI RING dot LED 230V suspended

multicolour - 06

additional white-black

for:
REVEL dot LED 230V suspended
MAXI RING dot LED 230V suspended

white-black - 46

additional black-gold

QS for MAXI RING dot LED 230V suspended

black-gold - 42

all versions

Configure your product using the fold-out or our website.

LED integrated

power: dependent on version
CRI: CRI>90
CCT:
3000K | 4000K | 2700-6500K —
MAXI RING LED suspended
3000K | 4000K —
REVEL LED suspended
dimming optional: DALI | switchDIM | AQsmart

LED 230V integrated

power: dependent on version
CRI: CRI>80
CCT: 2700 | 3000K | 4000K
dimming standard: Phase-Control

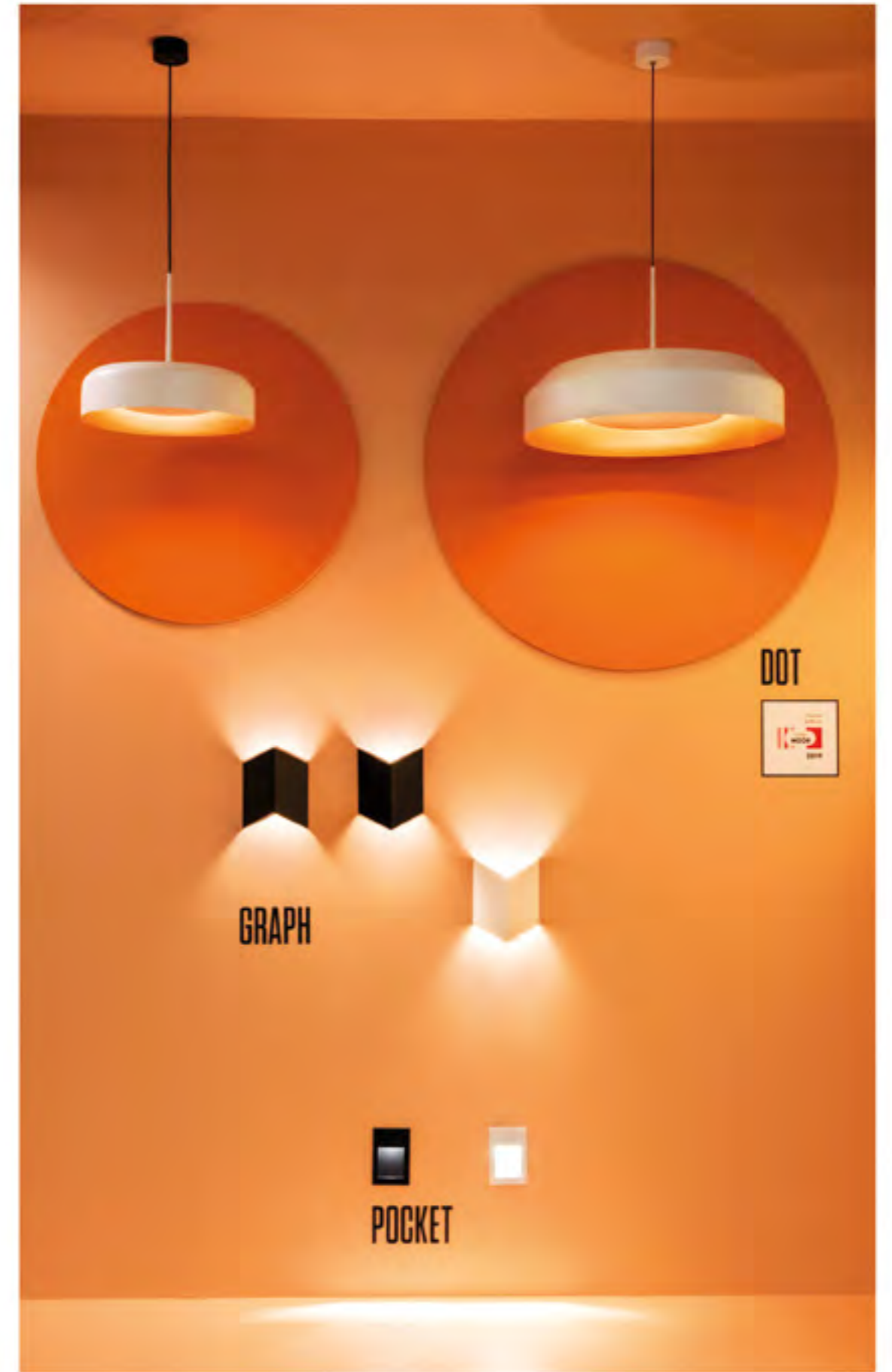

GLOB



Round shape of GLOB is a tasteful accent of any home decoration. Geometrical form and minimalistic design make GLOB delicate addition, that can brake monotony of the space. Thanks to the recessed light source, emitted light is gently diffused, providing high visual comfort without unpleasant glare. I can cope very well with lighting tables, bars or counters, while keeping its decorative character that can easily correspond with other interior accessories.

Krągły kształt oprawy GLOB to gustowny akcent każdej aranżacji. Geometryczny charakter oraz minimalistyczne wzornictwo czynią tę oprawę nienachalnym dodatkiem, przelamującym monotonię wnętrza. Dzięki zagłębieniu źródła światła, oprawa ta emituje przyjemnie rozproszone światło, gwarantujące komfort wizualny, bez przykrego efektu olśnienia. Doskonale radzi sobie jako oświetlenie stolów, barów i wysp, zachowując przy tym swój dekoracyjny charakter, korespondujący z resztą dodatków.



standard type

GLOB simple suspended

aqform.com/50120

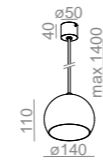

Standard | E14 | Phase-Control

power

max: 40.0W

cat. no

50120-0000-U8-PH-__

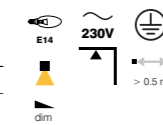

finishes

standard matt structure



additional



additional gloss



all versions

Configure your product using the fold-out or our website.

Standard E14

power: max: 40.0W

dimming standard: Phase-Control

light source not included

KARI



If you want to accent a charming detail that gives your interior its special character, KARI is a proposition for you. Its unique shape and minimalistic design make it fashionable accessory in any stylish interior. KARI would deal with accent lighting at home, as well as in office or restaurants. It is a perfect team player when placed over a table or reception desk. This inconspicuous luminaire is a genuine style icon that underlines all the elements which should not be missed.

Chcąc zaakcentować urok detalu, który nadaje szczególny charakter naszemu wnętrzu, warto sięgnąć po oprawę KARI. Jej wyjątkowy kształt i minimalistyczny design czynią ją modnym dodatkiem każdej stylowej przestrzeni. KARI świetnie poradzi sobie zarówno w domu, jak i w restauracji czy w biurze. Doskonale prezentuje się także w grupie, wisząc nad stołem lub recepcją. Ta niepozorna oprawa to istna ikona stylu, podkreślająca elementy, które nie powinny umknąć naszej uwadze.



luminaire family

 [p.260](#)

 [p.392](#)

standard type

KARI LED 230V suspended

aqform.com/KA0075



CRI>90 | 3000K | 36° | Phase-Control

power	flux	cat. no
8.0W	620lm	50528-M930-F1-PH-__

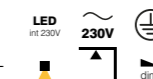

KARI LED 230V spider suspended

aqform.com/K10075

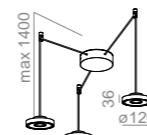

In spider version lamp canopies are available for up to three, five or eight modules.

More info: aqform.com on page 392.

finishes

standard matt structure

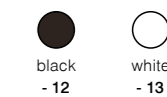

additional

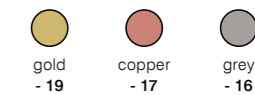

all versions

Configure your product using the fold-out or our website.

LED 230V integrated

power: 8.0W
 CRI: CRI>90
 CCT: 2700K | 3000K | 4000K
 beam angle: 36°
 dimming standard: Phase-Control

TUBA





TUBA is a timeless elegance. It is a perfect supplement for many interiors and its versatility makes numerous applications possible. When performing solo, it is a very good solution for accenting important details like favourite painting, plant or coffee table. It helps in making bedroom atmosphere more relaxing by delicately lighting up nightstands. In a group, it is a perfect choice for communication zones and offices. Its form and minimalistic design make it timeless and always fashionable.

TUBA to ponadczasowość i elegancja w jednym. To doskonale uzupełnienie każdej aranżacji, a jej wszechstronność daje szeroki wachlarz zastosowań. Występując solo może służyć jako oświetlenie akcentujące ważny element mieszkania, podkreślić ulubiony obraz, roślinę czy stolik kawowy. Wprowadza nastrojową atmosferę w sypialni, delikatnie rozświetlając pomieszczenie. W grupie swoje zastosowanie znajdzie w przestrzeniach komunikacyjnych oraz biurowych. Jej geometryczna forma oraz minimalistyczny design czynią ją ponadczasową i zawsze modną.



luminaire family

-  [p.120 / 122](#)
-  [p.258](#)
-  [p.320](#)

standard type

TUBA 111 QRLED suspended

aqform.com/TU0065

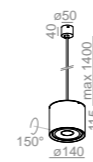

CRI>90 | 3000K | 38° | non dim

power	flux	cat. no
6.0W	880lm	50254-L930-F1-00-__
9.0W	1200lm	50254-M930-F1-00-__



TUBA 111 QRLED 230V suspended

aqform.com/TU0165

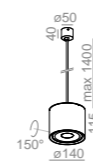

CRI>90 | 3000K | 38° | Phase-Control

power	flux	cat. no
8.0W	620lm	50256-M930-F1-PH-__
12.0W	920lm	50256-H930-F1-PH-__

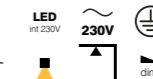

TUBA 111 suspended

aqform.com/59631

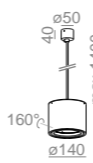

AR111, 12V AC | G53 | Phase-Control

power	cat. no
max: 35.0W, LED 12.5W	59631-0000-T8-PH-__

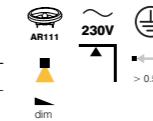

TUBA 111 230V suspended

aqform.com/59641

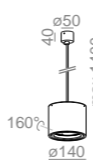

ES111, 230V | GU10 | Phase-Control

power	cat. no
max: 35.0W	59641-0000-U8-PH-__

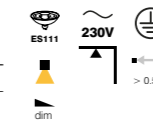

finishes

standard matt structure

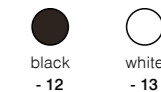

additional

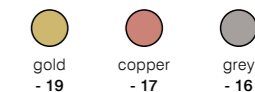

additional gloss

for:

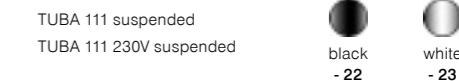

additional multicolour

for:

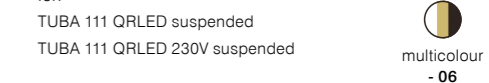

all versions

Configure your product using the fold-out or our website.

LED integrated

power: dependent on version
CRI: CRI>90
CCT: 2700 | 3000K | 4000K
beam angle: 38°
dimming optional: Phase-Control

LED 230V integrated

power: dependent on version
CRI: CRI>90
CCT: 2700 | 3000K | 4000K
beam angle: 38°
dimming standard: Phase-Control

AR111, 12V

power: max: 35.0W, LED 12.5W
dimming standard: Phase-Control
 light source not included

ES111, 230V

power: max: 35.0W
dimming standard: Phase-Control
 light source not included



QUPET





This minimalistic form of cuboid hides plenty of possibilities inside. Simple design of QUPET corresponds perfectly with elegant interiors, underlining their noble character. It is also the key player if a single detail needs to be accentuated. It fits well communication areas in offices or hotels. Lighting a nightstand using QUPET is a good idea, as it is perfect for reading without making the entire bedroom too bright. Applied in groups, QUPET becomes a functional decoration in large interiors.

Ta minimalistyczna forma prostopadłościanu kryje w sobie zaskakująco wiele możliwości. Proste wzornictwo kolekcji QUPET idealnie koresponduje z eleganckimi wnętrzami, podkreślając ich dystyngowany charakter. Oprawa ta gra pierwsze skrzypce, kiedy chcemy światłem zaakcentować wybrany detal. Świetnie sprawdzi się także w przestrzeniach komunikacyjnych, biurowych czy hotelowych. Będzie również doskonałym rozwiązaniem w sypialni, kiedy mamy ochotę poczytać przed snem bez nadmiernego rozświetlenia całego wnętrza. Z kolei zastosowana w grupie doskonale sprawdzi się w większych przestrzeniach.



luminaire family

-  [p.130](#)
-  [p.246](#)
-  [p.314](#)

standard type

QUPET mini LED suspended

aqform.com/QU1015



CRI>90 | 3000K | 36° | non dim

length	power	flux	cat. no
170mm	3.0W	380lm	50525-M930-F1-00-__
250mm	3.0W	380lm	50526-M930-F1-00-__
370mm	3.0W	380lm	50527-M930-F1-00-__
500mm	3.0W	380lm	50586-M930-F1-00-__



QUPET 12 LED 230V suspended

aqform.com/QU0075



CRI>90 | 3000K | Phase-Control

power	flux	cat. no
8.0W	620lm	50420-M930-D9-PH-__

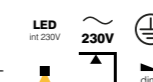

QUPET suspended

aqform.com/51411

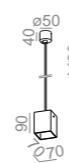

PAR16, 230V | GU10 | Phase-Control

power	cat. no
max: LED 8.0W	51411-0000-U8-PH-__



finishes

standard matt structure

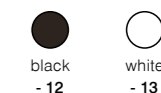

additional



additional gloss

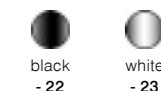

additional multicolour

for QUPET mini LED suspended



all versions

Configure your product using the fold-out or our website.

LED integrated

power: 3.0W
CRI: CRI>90
CCT: 2700 | 3000K | 4000K
beam angle: 20° | 36°

LED 230V integrated

power: 8.0W
CRI: CRI>90
CCT: 2700 | 3000K | 4000K
dimming standard: Phase-Control

PAR16, 230V

power: max: LED 8.0W
dimming standard: Phase-Control
light source not included

CADRA



Rectangular variations of CADRA family are somewhat intriguing. Raw, yet not trivial design and numerous combinations make CADRA a great solution e.g. for dining rooms. They can also be easily used as accent lighting, focusing attention on the most important details of an interior. These luminaires are coping very well with communication zones and large rooms providing pleasant general lighting. They are a successful mixture of comfortable parameters and raw charm of a rectangle.

Prostokątne wariacje opraw z rodziny CADRA kryją w sobie coś intrygującego. Surowe, a zarazem niebanalne wzornictwo oraz różnorodność kombinacji stanowią przykładowo doskonale uzupełnienie jadalni. Z powodzeniem sprawdzą się także w roli oświetlenia akcentującego, podkreślając najważniejsze elementy wnętrza. Oprawy te dobrze radzą sobie w przestrzeniach komunikacyjnych oraz w dużych wnętrzach, gwarantując przyjemne oświetlenie ogólne. To udane połączenie komfortowych parametrów z geometrycznym wdziękiem surowego czworoboku.



luminaire family

— | p.326

standard type

CADRA 111x1 230V suspended

aqform.com/54611

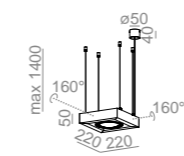

ES111, 230V | GU10 | Phase-Control

power
max: 50.0W

cat. no

54611-0000-U8-PH-__

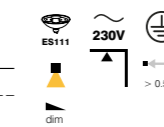

CADRA 111x2 230V suspended

aqform.com/54712

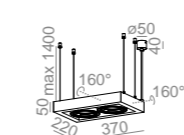

ES111, 230V | GU10 | Phase-Control

power
max: 2x 50.0W

cat. no

54712-0000-U8-PH-__

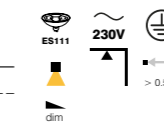

CADRA 111x3 230V suspended

aqform.com/54813

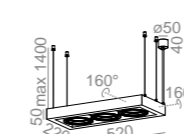

ES111, 230V | GU10 | Phase-Control

power
max: 3x 50.0W

cat. no

54813-0000-U8-PH-__

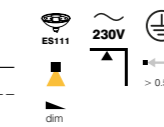

CADRA 111x4 230V suspended

aqform.com/54914

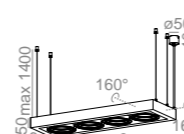

ES111, 230V | GU10 | Phase-Control

power
max: 4x 50.0W

cat. no

54914-0000-U8-PH-__

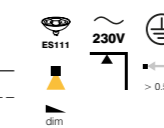

CADRA 111x4 SQ 230V suspended

aqform.com/55014

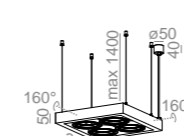

ES111, 230V | GU10 | Phase-Control

power
max: 4x 50.0W

cat. no

55014-0000-U8-PH-__

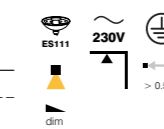

finishes

standard matt structure



additional



additional gloss

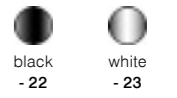

additional multicolour



all versions

Configure your product using the fold-out or our website.

ES111, 230V

power: max: 50.0W

dimming standard: Phase-Control
light source not included

BIG SIZE round



administrative and office building Nadleśnictwo Dretyń | design: LOFFT ARCHITEKTURA Małgorzata Hendrych-Lubińska

BIG SIZE collection is both large in size and in its abilities. These luminaires are mostly recommended for spacious rooms, where they can easily provide high light intensity both on floor and walls. Thanks to power control as a standard, they ideally meet requirements of given application. Optional colour temperature control allows to easily change sunset-like light (2700K) into an awakening noon light (6500K). Version with a microprismatic cover is recommended for offices and other spaces, where UGR<19 is required.

Kolekcja BIG SIZE to oprawy o dużych gabarytach i jeszcze większych możliwościach. Rekomendowane są przede wszystkim do większych przestrzeni, gdzie bez problemu oświetlą z dużym natężeniem podłogę oraz doświetlą ściany. Dzięki standardowo dostępnej regulacji mocy, można je idealnie dopasować do wymagań pomieszczenia. Opcja regulowanej temperatury barwowej pozwala jednym kliknięciem zmienić światło od przypominającego zachodzące słońce (2700K) do pobudzającego światła południowego (6500K). Wariant z przesłoną mikropryzmatyczną jest dedykowany oświetleniu biur i innych przestrzeni, gdzie wymagane jest UGR<19.



luminaire family

— p.078

— p.142

standard type

AQsmart

BIG SIZE next round LED suspended

aqform.com/BS1115

CRI>90 | 3000K | non dim

diameter	power (min – max)	flux (min – max)	cat. no
450mm	10.0 – 17.5W	1530 – 2670lm	59788-A930-D9-00-__
660mm	21.5 – 38.5W	3310 – 5790lm	50259-A930-D9-00-__
960mm	39.5 – 71.0W	6120 – 10700lm	50261-A930-D9-00-__
1220mm	72.5 – 130.0W	11220 – 19620lm	50263-A930-D9-00-__

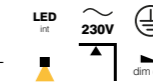

new

BIG SIZE PRO next round LED suspended

aqform.com/BS1115

AQsmart

CRI>90 | 3000K | non dim

diameter	power (min – max)	flux (min – max)	cat. no
450mm	10.0 – 17.5W	1530 – 2670lm	59789-A930-D5-00-__
660mm	21.5 – 38.5W	3310 – 5790lm	59790-A930-D5-00-__
960mm	39.5 – 71.0W	6120 – 10700lm	59791-A930-D5-00-__
1220mm	72.5 – 130.0W	11220 – 19620lm	59792-A930-D5-00-__



covers comparison



regular (opal)

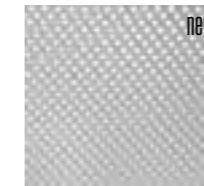

PRO (microprism)

See PRO lighting effect on the website

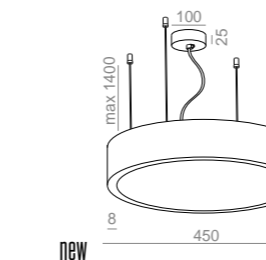
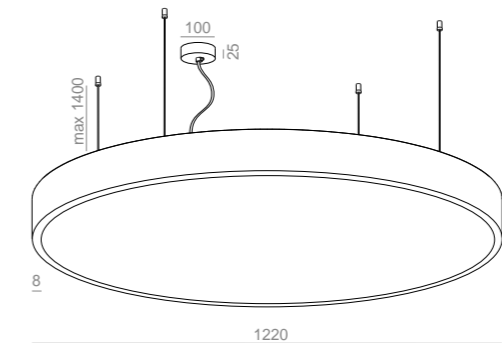
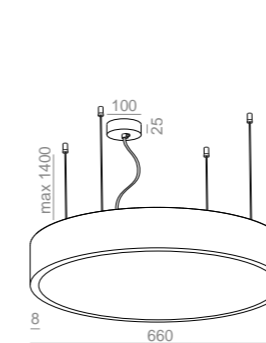

new

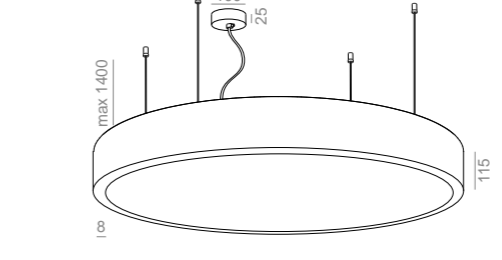

finishes

standard matt structure



additional



all versions

Configure your product using the fold-out or our website.

LED integrated

power:

ø450mm — 10.0 – 17.5W¹ | 30W²

ø660mm — 21.5 – 38.5W¹ | 70.0W²

ø960mm — 39.5 – 71.0W¹ | 150.0W²

ø1220mm — 72.5 – 130.0W¹ | 250.0W²

CRI: CRI>90

CCT: 3000K | 4000K | 2700-6500K

dimming optional: DALI | switchDIM | AQsmart

¹ adjustable power is available for CCT 3000K and 4000K

² Tunable-White (2700-6500K) has power always set for M and requires DALI or AQsmart control

BIG SIZE square



Some say, best things come in small packages, but how about when it comes to large spaces lighting? BIG SIZE, dedicated exactly for such rooms, comes to rescue. Wide range of powers, many sizes and unified, minimalist design. One BIG SIZE luminaire can easily deal with lighting 10m², even if installed over 4m height. Thanks to well diffused light, it does not require additional help.

Podobno małe jest piękne, ale jak poradzić sobie z oświetleniem naprawdę dużych przestrzeni? Z pomocą przychodzi kolekcja BIG SIZE, dedykowana tego typu wnętrzom. Duża rozpiętość mocy, wiele rozmiarów, zuniifikowany, minimalistyczny design. Jedna oprawa BIG SIZE z łatwością poradzi sobie z oświetleniem 10m² nawet, jeśli zamocowana jest na wysokości powyżej 4m. Dzięki szerokiemu rozsyłowi światła, nie wymaga przy tym dodatkowego wsparcia.



luminaire family

- p.080
- p.144

standard type

AQsmart

BIG SIZE next square LED suspended

aqform.com/BS1215

CRI>90 | 3000K | non dim

size	power (min – max)	flux (min – max)	cat. no
300x600mm	13.0 – 23.5W	2040 – 3560lm	50278-A930-D9-00-__
300x900mm	20.0 – 35.5W	3060 – 5350lm	50276-A930-D9-00-__
300x1200mm	26.5 – 47.0W	4080 – 7130lm	50280-A930-D9-00-__
600x600mm	26.5 – 47.0W	4080 – 7130lm	50264-A930-D9-00-__
600x900mm	39.5 – 71.0W	6120 – 10700lm	50266-A930-D9-00-__
600x1200mm	53.0 – 94.5W	8160 – 14270lm	50268-A930-D9-00-__
900x900mm	59.5 – 106.0W	9180 – 16050lm	50270-A930-D9-00-__
900x1200mm	69.5 – 124.0W	10710 – 18730lm	50272-A930-D9-00-__
1200x1200mm	92.5 – 165.0W	14280 – 24970lm	50274-A930-D9-00-__

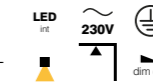

finishes

standard matt structure

additional

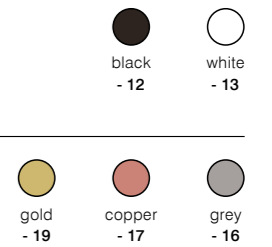

new

BIG SIZE PRO next square LED suspended

aqform.com/BS1215

AQsmart

CRI>90 | 3000K | non dim

size	power (min – max)	flux (min – max)	cat. no
300x600mm	13.0 – 23.5W	2040 – 3560lm	59795-A930-D5-00-__
300x900mm	20.0 – 35.5W	3060 – 5350lm	59796-A930-D5-00-__
300x1200mm	26.5 – 47.0W	4080 – 7130lm	59794-A930-D5-00-__
600x600mm	26.5 – 47.0W	4080 – 7130lm	59800-A930-D5-00-__
600x900mm	39.5 – 71.0W	6120 – 10700lm	59801-A930-D5-00-__
600x1200mm	53.0 – 94.5W	8160 – 14270lm	59797-A930-D5-00-__
900x900mm	59.5 – 106.0W	9180 – 16050lm	59799-A930-D5-00-__
900x1200mm	69.5 – 124.0W	10710 – 18730lm	59798-A930-D5-00-__
1200x1200mm	92.5 – 165.0W	14280 – 24970lm	59793-A930-D5-00-__



covers comparison



regular (opal)



PRO (microprism)

See PRO lighting effect on the website

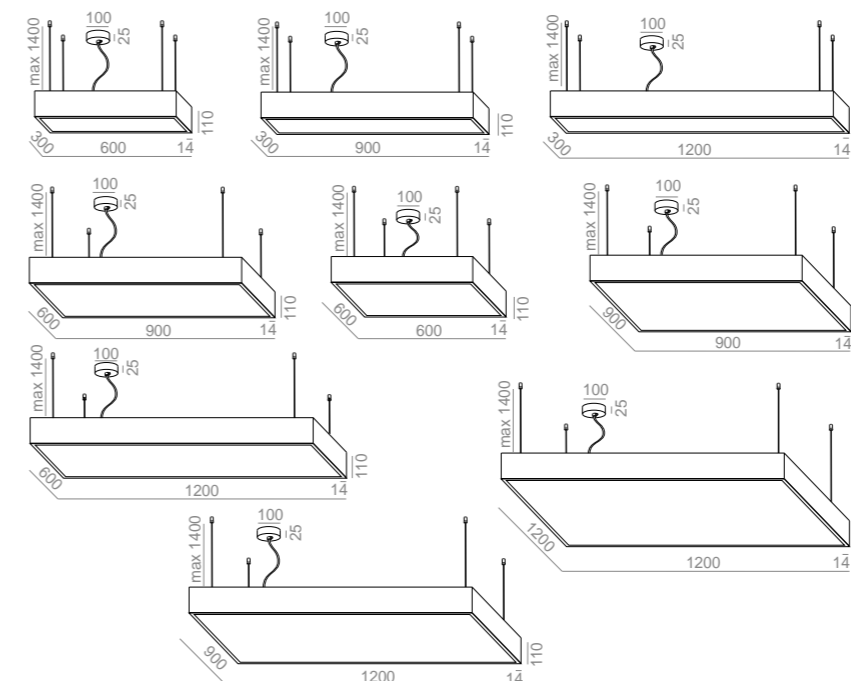

all versions

Configure your product using the fold-out or our website.

LED integrated

power:

- 300x600mm — 13.0 – 23.5W¹ | 40.0W²
- 300x900mm — 20.0 – 35.5W¹ | 60.0W²
- 300x1200mm — 26.5 – 47.0W¹ | 80.0W²
- 600x600mm — 26.5 – 47.0W¹ | 80.0W²
- 600x900mm — 39.5 – 71.0W¹ | 120.0W²
- 600x1200mm — 53.0 – 94.5W¹ | 160.0W²
- 900x900mm — 59.5 – 106.0W¹ | 180.0W²
- 900x1200mm — 69.5 – 124.0W¹ | 240.0W²
- 1200x1200mm — 92.5 – 165.0W¹ | 320.0W²

CRI: CRI>90

CCT: 3000K | 4000K | 2700-6500K

dimming optional: DALI | switchDIM | AQsmart

¹ adjustable power is available for CCT 3000K and 4000K

² Tunable-White (2700-6500K) has power always set for M and requires DALI or AQsmart control

equilibra

Designed in collaboration with Piotr Jagiellovicz Design





Thanks to its unique suspension system, equilibra BALANS seems to evade laws of physics. Don't get mistaken. It is the magic of physics fitted into a simple form, which provides such an extraordinary effect. Asymmetrically suspended equilibra BALANS emphasises unique style of interior. Attention to details, characteristic curves and minimalist look all together make equilibra's form original, and solid, yet subtle. Entire collection is an effect of great cooperation between AQForm and Polish designer Piotr Jagiellovicz. This luminaire creates unlimited possibilities for creative applications.

Oprawa equilibra BALANS, poprzez swój unikalny sposób zawieszenia, może wydawać się swoistym zaprzeczeniem prawom fizyki. Nic bardziej mylnego! To magia fizyki zawarta w prostej bryle daje tak niesamowity efekt. Asymetrycznie zawieszona equilibra BALANS podkreśla wyjątkowy styl wnętrza. Dbalność o detale, charakterystyczne zaokrąglenia oraz minimalistyczne wzornictwo tworzą oryginalną, solidną, a zarazem subtelną formę. Cała kolekcja equilibra jest owocem współpracy z polskim projektantem Piotrem Jagielloviczem. Jej wielofunkcyjność daje liczne możliwości na kreatywne wykorzystanie oprawy.



function

luminaire family

-  [p.146](#)
-  [p.338](#)

standard type



equilibra BALANS LED suspended

aqform.com/EQ0011

CRI>90 | 3000K | non dim

length	power	flux	cat. no
920mm	27.5W	3020lm	50041-M930-D0-00-__
1200mm	37.0W	4030lm	50042-M930-D0-00-__
1480mm	46.0W	5040lm	50043-M930-D0-00-__

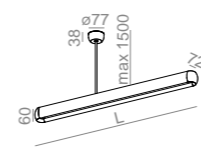

equilibra DIRECT LED suspended

aqform.com/EQ0031

CRI>90 | 3000K | non dim

length	power	flux	cat. no
640mm	17.5W	2430lm	50061-M930-D9-00-__
920mm	26.0W	3640lm	50062-M930-D9-00-__
1200mm	35.0W	4860lm	50063-M930-D9-00-__
1480mm	43.5W	6070lm	50064-M930-D9-00-__

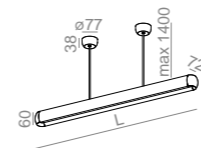
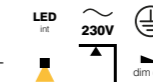

equilibra CENTRAL DIRECT LED suspended

aqform.com/EQ0231

CRI>90 | 3000K | non dim

length	power	flux	cat. no
640mm	17.5W	2430lm	50093-M930-D9-00-__
920mm	26.0W	3640lm	50094-M930-D9-00-__
1200mm	35.0W	4860lm	50095-M930-D9-00-__
1480mm	43.5W	6070lm	50096-M930-D9-00-__

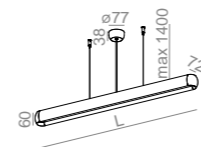
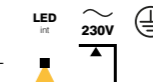

equilibra SOFT LED suspended

aqform.com/EQ0021

CRI>90 | 3000K | non dim

length	power	flux	cat. no
640mm	18.5W	2010lm	50049-M930-D0-00-__
920mm	27.5W	3020lm	50050-M930-D0-00-__
1200mm	37.0W	4030lm	50051-M930-D0-00-__
1480mm	46.0W	5040lm	50052-M930-D0-00-__

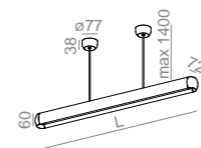

finishes

standard matt structure



additional



additional gloss

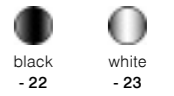

all versions

Configure your product using the fold-out or our website.

LED integrated

power:¹

equilibra DIRECT LED suspended, equilibra CENTRAL DIRECT LED suspended
 640mm — 9.0W | 17.5W
 920mm — 13.0W | 26.0W
 1200mm — 17.5W | 35.0W
 1480mm — 22.0W | 43.5W

CRI: CRI>90

CCT:

3000K | 4000K —
 equilibra BALANS
 equilibra SOFT LED suspended
 2700K | 3000K | 4000K —
 equilibra DIRECT LED suspended
 equilibra CENTRAL DIRECT LED suspended

dimming optional:

DALI | switchDIM —
 equilibra DIRECT 92 LED suspended
 equilibra DIRECT 120 LED suspended
 equilibra DIRECT 148 LED suspended

¹ all power versions for equilibra BALANS and equilibra SOFT are shown in standard product tables



private apartment, Ruda Śląska | design: Modus Architekci, Zabrze | photo: Noysei

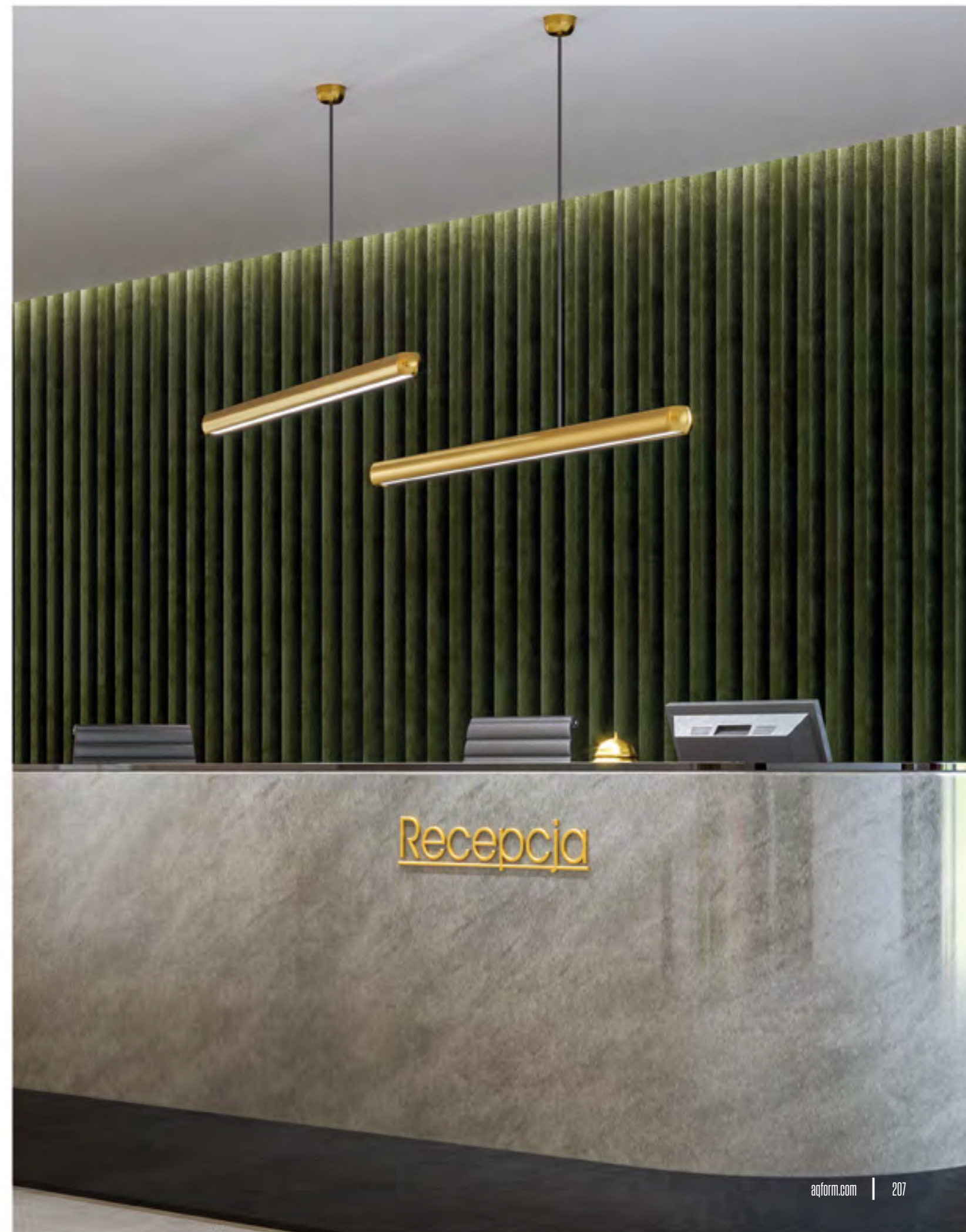

LENS LINE





Gabinety Lekarskie, Poznań | design: inDe projekt | photo: Bartek Bieliński fotografia

LENS LINE collection is an elegant way for task or accent lighting, as well as general lighting, if applied in groups. Thanks to advanced optics, glare was reduced to minimum. It is a brilliant solution, especially for brightening long, flat or rectangular surfaces. In everyday life LENS LINE is a perfect solution for art galleries, offices, communication areas, as well as living rooms or kitchen countertops.

Kolekcja LENS LINE to elegancki sposób na oświetlenie zadaniowe lub akcentujące, jak również funkcjonalne oświetlenie ogólne. Dzięki zastosowaniu zaawansowanego systemu optyki, przykry efekt olśnienia został zniwelowany do minimum. To świetne rozwiązanie szczególnie przy oświetlaniu długich, płaskich lub prostokątnych powierzchni. W życiu codziennym LENS LINE znakomicie sprawdzi się w galeriach sztuki, biurach i przestrzeniach komunikacyjnych, a także jako dekoracja salonu lub oświetlenie wyspy kuchennej.



luminaire family

-  [p.082](#)
-  [p.148](#)
-  [p.402](#)

standard type

AQsmart

LENS LINE LED section suspended

aqform.com/LL0615

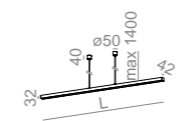

CRI>90 | 3000K | 54° | non dim

length	power	flux	cat. no
960mm	14.5W	1530lm	50282-M930-W3-00-__
1490mm	22.0W	2290lm	50284-M930-W3-00-__
2020mm	29.0W	3060lm	50286-M930-W3-00-__

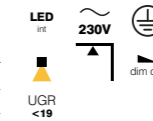

AQsmart

LENS LINE 180x89 LC LED suspended

aqform.com/LL4015

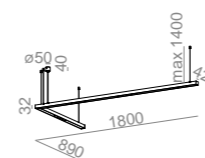

CRI>90 | 3000K | 54° | non dim

power	flux	cat. no
14.0W	1630lm	50468-L930-W3-00-__
29.0W	3060lm	50468-M930-W3-00-__

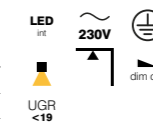

AQsmart

LENS LINE 180x89 RC LED suspended

aqform.com/LL3015

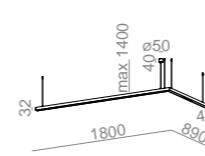

CRI>90 | 3000K | 54° | non dim

power	flux	cat. no
14.0W	1630lm	50444-L930-W3-00-__
29.0W	3060lm	50444-M930-W3-00-__

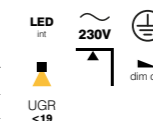

AQsmart

LENS LINE 89x89 SQ LED suspended

aqform.com/LL5015

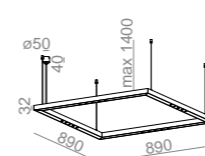

CRI>90 | 3000K | 54° | non dim

power	flux	cat. no
14.0W	1630lm	50445-L930-W3-00-__
29.0W	3060lm	50445-M930-W3-00-__

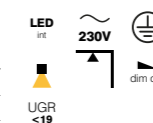

finishes

standard matt structure

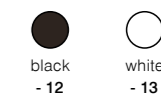

additional



all versions

Configure your product using the fold-out or our website.

LED integrated

power:¹

LENS LINE LED section suspended
 960mm — 7.0W | 14.5W
 1490mm — 10.5W | 22.0W
 2020mm — 14.0W | 29.0W

CRI: CRI>90

CCT: 2700 | 3000K | 4000K

beam angle: 26° | 54°

dimming optional: DALI | switchDIM | AQsmart

¹ all power versions for LENS LINE 180x89 LC, LENS LINE 180x89 RC and LENS LINE 89x89 SQ are shown in standard product tables

MIXLINE





private apartment | Poznań | design: LOFFT ARCHITEKTURA Małgorzata Hendrych-Lubińska

Carefully picked details determine final effect of every interior design. MIXLINE is a successful mixture of general and task lighting. It is a synonym of elegance in a simple form. It is also a subtle decoration, that provides efficient lighting. Thanks to its linear form, it is a perfect solution for long surfaces, countertops and corridors. Wide range of MIXLINE possible applications gives this luminaire plenty of purposes. Most importantly, it will be a gentle detail that adds beauty to the space.

Starannie dobrany detal jest stylowym uzupełnieniem każdej aranżacji. MIXLINE to udane połączenie oświetlenia ogólnego i zadaniowego. To synonim klasyki i elegancji zawarty w prostej formie. To także subtelna ozdoba, która oferuje wydajne światło. Dzięki swej liniowej formie, oprawa z powodzeniem sprawdzi się przy oświetlaniu podłużnych elementów, pięknie rozjaśniając obrazy, stoły, blaty kuchenne czy korytarze. Wszelkieronność MIXLINE powoduje, że oprawa ta znajdzie wiele zastosowań, a przede wszystkim będzie nienachalnym dodatkiem, zdobiącym naszą przestrzeń.



luminaire family

-  [p.082](#)
-  [p.150](#)
-  [p.402](#)

standard type

AQsmart **MIXLINE LED suspended** aqform.com/MX0015

CRI>90 3000K 54° non dim				LED int	230V	dim opt
length	power	flux	cat. no			
1600mm	15.5W	2030lm	50438-M930-W3-00-__			
1880mm	24.5W	3240lm	50439-M930-W3-00-__			
2160mm	33.0W	4460lm	50440-M930-W3-00-__			

AQsmart **MIXLINE INV LED suspended** aqform.com/MX1015

CRI>90 3000K 54° non dim				LED int	230V	dim opt
length	power	flux	cat. no			
1670mm	21.0W	2830lm	50441-M930-W3-00-__			
1920mm	24.5W	3240lm	50442-M930-W3-00-__			

AQsmart **MIXLINE 120x89 RT LED suspended** aqform.com/MX2015

CRI>90 3000K 54° non dim				LED int	230V	dim opt
power	flux	cat. no				
42.0W	5670lm	50443-M930-W3-00-__				

How covers and lenses are placed



finishes

standard matt structure

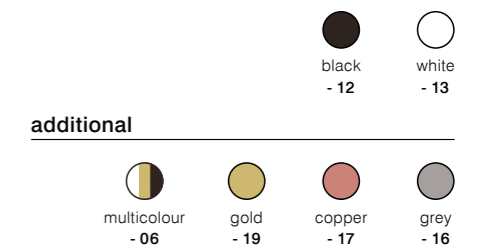

all versions

Configure your product using the fold-out or our website.

LED integrated

power: dependent on version
 CRI: CRI>90
 CCT: 2700 | 3000K | 4000K
 beam angle: 26° | 54°
 dimming optional: DALI | switchDIM | AQsmart



SET RAW mini



Wide spectrum of SET RAW mini application opens a wide range of design possibilities. This minimalistic profile would perfectly fit both in homes and public spaces. SET RAW mini will cope well with corridor, office or kitchen lighting. Its domain are tall interiors, where it can truly show its full potential. Its ascetic design adds elegancy to interiors. Class and refined design in simple and pure form.

Szerokie spektrum zastosowań SET RAW mini otwiera wachlarz różnych możliwości projektowych. To minimalistyczne oświetlenie, które znakomicie wpasowuje się zarówno w przestrzenie domowe, jak i komercyjne. SET RAW mini doskonale sprawdzi się w korytarzach, biurach czy w kuchni. Domeną SET RAW mini są wysokie wnętrza i to właśnie tam oprawa może pokazać pełnię swoich możliwości. Jej ascetyczne wzornictwo dodaje wnętrzom niekwestionowanej elegancji. Klasa i design w czystej postaci.



function

luminaire family

-  [p.086](#)
-  [p.376](#)
-  [p.156](#)
-  [p.414](#)
-  [p.302](#)

standard type

AQsmart

SET RAW mini LED suspended

aqform.com/SR1015

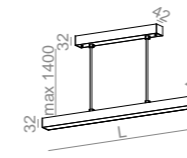

CRI>90 | 3000K | non dim

length	power	flux	cat. no
580mm	17.5W	2430lm	50359-M930-D9-00-__
720mm	22.0W	3030lm	50577-M930-D9-00-__
870mm	26.0W	3640lm	50361-M930-D9-00-__
1010mm	30.5W	4250lm	50578-M930-D9-00-__
1150mm	35.0W	4860lm	50363-M930-D9-00-__
1430mm	43.5W	6070lm	50365-M930-D9-00-__
1710mm	52.0W	7290lm	50367-M930-D9-00-__
1990mm	61.0W	8500lm	50369-M930-D9-00-__

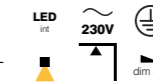

finishes

standard matt structure



additional



additional gloss



all versions

Configure your product using the fold-out or our website.

LED integrated

power: dependent on version

CRI: CRI>90

CCT: 2700 | 3000K | 4000K

dimming optional:

DALI | switchDIM | AQsmart —

- SET RAW mini 87 LED suspended
- SET RAW mini 101 LED suspended
- SET RAW mini 115 LED suspended
- SET RAW mini 143 LED suspended
- SET RAW mini 171 LED suspended
- SET RAW mini 199 LED suspended

RAFTER





RAFTER is based on optic systems for task and general lighting. In order to meet different needs of the users, two variants were prepared: one with set of reflectors recessed deep into luminaire and one with a cover. Reflector-based version easily allows UGR<13 due to recess of the light sources and black finish. It is an efficient task lighting that can perfectly accentuate certain surface or provide much higher illuminance at working area. Version with cover, which gently diffuses light is on the other hand a perfect proposition for general lighting.

RAFTER bazuje na układach optycznych do oświetlenia zadaniowego i ogólnego. W odpowiedzi na zróżnicowane potrzeby użytkowników, do wyboru mamy dwa warianty: z zestawem reflektorów zagłębionych w oprawie oraz z przesłoną. Wersja z reflektorami, dzięki cofnięciu źródeł światła oraz zastosowaniu czarnych wykończeń, pozwala łatwo uzyskać nawet UGR<13. To skuteczne oświetlenie zadaniowe, które akcentuje przestrzeń lub znacznie podnosi natężenie oświetlenia na wybranej powierzchni. Z kolei model z przesłoną miękko rozpraszającą światło jest idealnym rozwiązaniem w oświetleniu ogólnym.



luminaire family

-  [p.094](#)
-  [p.158](#)
-  [p.268](#)
-  [p.336](#)
-  [p.422](#)

standard type

AQsmart RAFTER LED suspended aqform.com/RA0015

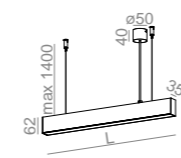

CRI>90 | 3000K | non dim

length	power	flux	cat. no
570mm	17.5W	2430lm	50600-M930-D9-00-__
860mm	26.0W	3640lm	50601-M930-D9-00-__
1140mm	35.0W	4860lm	50602-M930-D9-00-__
1420mm	43.5W	6070lm	50603-M930-D9-00-__
1700mm	52.0W	7290lm	50604-M930-D9-00-__

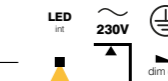

AQsmart RAFTER points 54 LED suspended aqform.com/RA1015

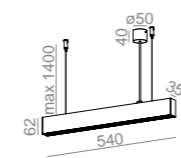

CRI>90 | 3000K | 50° | non dim

power	flux	cat. no
19.5W	2470lm	50597-L930-W1-00-__
41.0W	4340lm	50597-M930-W1-00-__

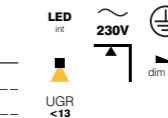

AQsmart RAFTER points LED section suspended aqform.com/RA1615

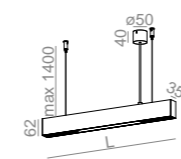

CRI>90 | 3000K | 50° | non dim

length	power	flux	cat. no
540mm	10.0W	1230lm	50593-L930-W1-00-__
940mm	15.0W	1850lm	50594-L930-W1-00-__
1330mm	19.5W	2470lm	50595-L930-W1-00-__
1730mm	24.5W	3090lm	50596-L930-W1-00-__

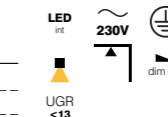

How lenses are placed in RAFTER points LED section

RAFTER points 54 LED section suspended



RAFTER points 94 LED section suspended



RAFTER points 133 LED section suspended



RAFTER points 173 LED section suspended



finishes

standard matt structure



additional



additional gloss

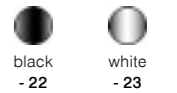

all versions

Configure your product using the fold-out or our website.

LED integrated

power:

RAFTER LED suspended
 570mm — 9.0W | 17.5W | 25.0W
 860mm — 13.0W | 26.0W | 37.5W
 1140mm — 17.5W | 35.0W | 50.0W
 1420mm — 22.0W | 43.5W | 62.5W
 1700mm — 26.5W | 52.0W | 75.0W

RAFTER points 54 LED suspended

19.5W | 41.0W

RAFTER points LED section suspended

540mm — 10.0W | 20.5W

940mm — 15.0W | 31.0W

1330mm — 19.5W | 41.0W

1730mm — 24.5W | 51.5W

CRI: CRI>90

CCT: 2700 | 3000K | 4000K

beam angle:

37° | 50° —

RAFTER points 54 LED suspended

RAFTER points LED section suspended

dimming optional:

DALI | switchDIM | AQsmart —

RAFTER LED suspended

RAFTER points 54 LED suspended

RAFTER points 94 LED section suspended

RAFTER points 133 LED section suspended

RAFTER points 173 LED section suspended

SET TRU



SET TRU collection makes no compromises in terms of technology, while maintaining simplicity and elegance. It is an embodiment of 'less is more' saying, as raw design underlines prestige of an interior. SET TRU luminaires perfectly complement high kitchen and communication areas or offices. They are very efficient, and thanks to PRO version allow to achieve high visual comfort easily. SET TRU renders colours very well and with AQsmart control and Tunable-White technology it can adjust to human needs depending on time of the day or mood of the user.

Kolekcja SET TRU nie idzie na kompromisy w zakresie technologii, zachowując przy tym prostotę i elegancję. To ucieleśnienie tezy, że „mniej znaczy więcej”. Surowy design SET TRU podkreśla prestiżowy charakter miejsca. Oprawy idealnie komponują się z wysokimi przestrzeniami jadalnymi, komunikacyjnymi i biurowymi. Są niezwykle wydajne, a dzięki wersji PRO pozwalają na łatwe uzyskanie wysokiego komfortu wizualnego. SET TRU doskonale odwzorowuje barwy, a ze sterowaniem AQsmart i regulowaną temperaturą barwową potrafi dostosować się do potrzeb ludzi w zależności od pory dnia lub nastroju.



luminaire family

- p.098
- | p.332
- p.164
- | p.378
- ↓ p.272
- | p.416

standard type

AQsmart

SET TRU LED suspended

aqform.com/BA0022

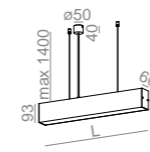

CRI>90 | 3000K | non dim

length	power	flux	cat. no
570mm	17.5W	2430lm	54549-M930-D9-00-__
860mm	26.0W	3640lm	54551-M930-D9-00-__
1140mm	35.0W	4860lm	54553-M930-D9-00-__
1420mm	43.5W	6070lm	54555-M930-D9-00-__
1700mm	52.0W	7290lm	54557-M930-D9-00-__

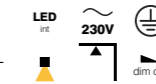

NEW

SET TRU PRO LED suspended

aqform.com/BA0022

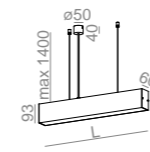

CRI>90 | 3000K | non dim

length	power	flux	cat. no
570mm	17.5W	2430lm	59811-M930-D5-00-__
860mm	26.0W	3640lm	59810-M930-D5-00-__
1140mm	35.0W	4860lm	59815-M930-D5-00-__
1420mm	43.5W	6070lm	59814-M930-D5-00-__
1700mm	52.0W	7290lm	59813-M930-D5-00-__

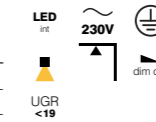

AQsmart

SET TRU up&down LED suspended

aqform.com/ST2015

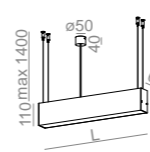

CRI>90 | 3000K | non dim

length	power	flux	cat. no
570mm	17.5W	2430lm	50184-L930-D9-00-__
860mm	26.5W	3640lm	50185-L930-D9-00-__
1140mm	35.0W	4860lm	50186-L930-D9-00-__
1420mm	44.0W	6080lm	50187-L930-D9-00-__
1700mm	53.0W	7290lm	50244-L930-D9-00-__

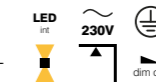

NEW

SET TRU PRO up&down LED suspended

aqform.com/ST2015

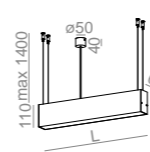

CRI>90 | 3000K | non dim

length	power	flux	cat. no
570mm	17.5W	2430lm	59805-L930-D5-00-__
860mm	26.5W	3640lm	59804-L930-D5-00-__
1140mm	35.0W	4860lm	59809-L930-D5-00-__
1420mm	44.0W	6080lm	59808-L930-D5-00-__
1700mm	53.0W	7290lm	59807-L930-D5-00-__

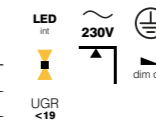

covers comparison



regular (opal)



PRO (microprism)

See PRO lighting effect on the website

finishes

standard matt structure



additional



additional gloss



all versions

Configure your product using the fold-out or our website.

LED integrated

power:

SET TRU LED suspended
 570mm — 9.0W | 17.5W
 860mm — 13.0W | 26.0W
 1140mm — 17.5W | 35.0W
 1420mm — 22.0W | 43.5W
 1700mm — 26.5W | 52.0W
 1980mm — 31.0W | 61.0W

SET TRU up&down LED suspended

570mm — 17.5W | 35.0W
 860mm — 26.5W | 52.0W
 1140mm — 35.0W | 69.5W
 1420mm — 44.0W | 87.0W
 1700mm — 53.0W | 104.5W
 1980mm — 61.5W | 122.0W

CRI: CRI>90

CCT: 2700 | 3000K | 4000K | 2700-6500K¹

dimming optional: DALI | switchDIM | AQsmart

¹ 2700-6500K from length 1140mm

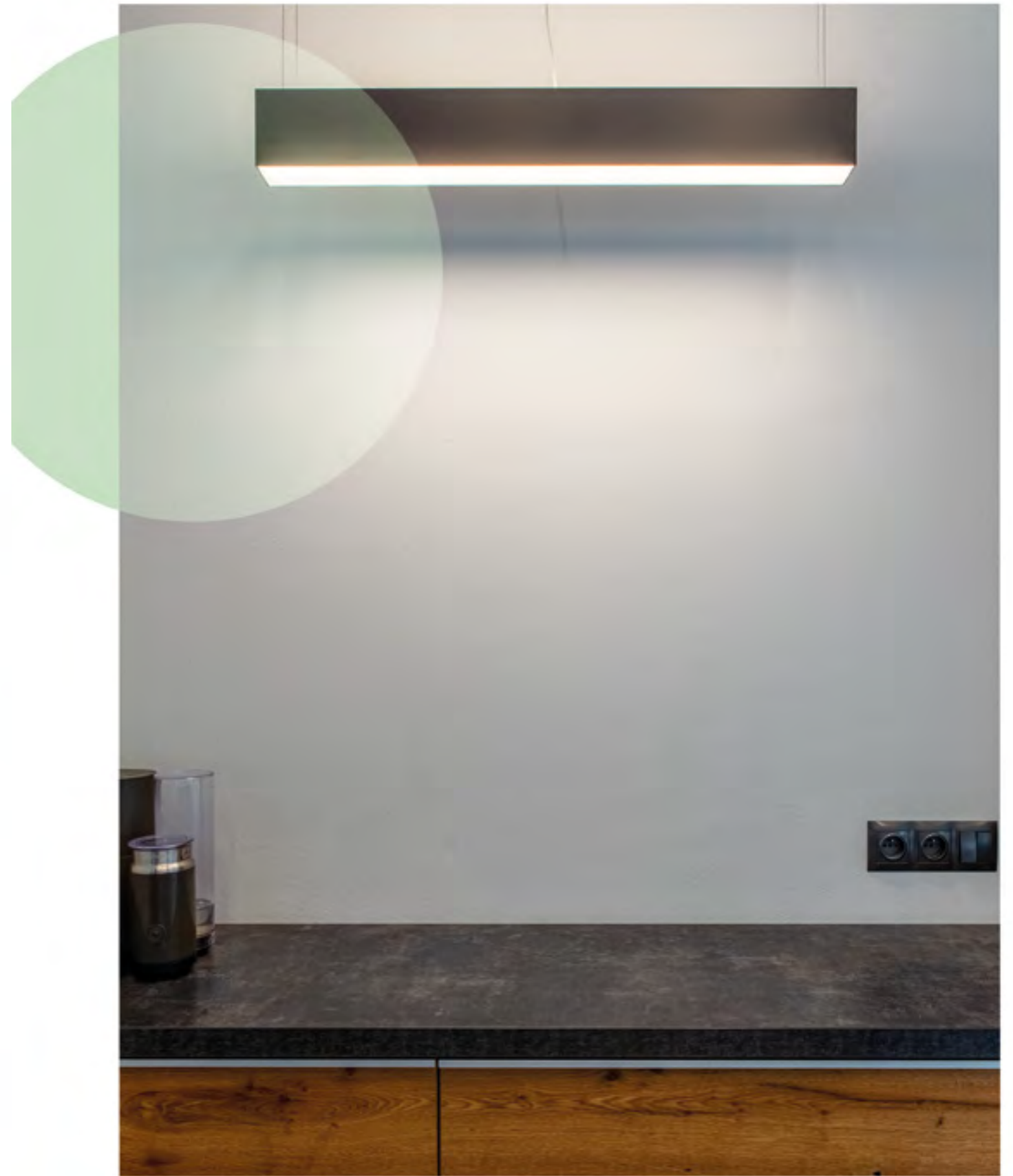
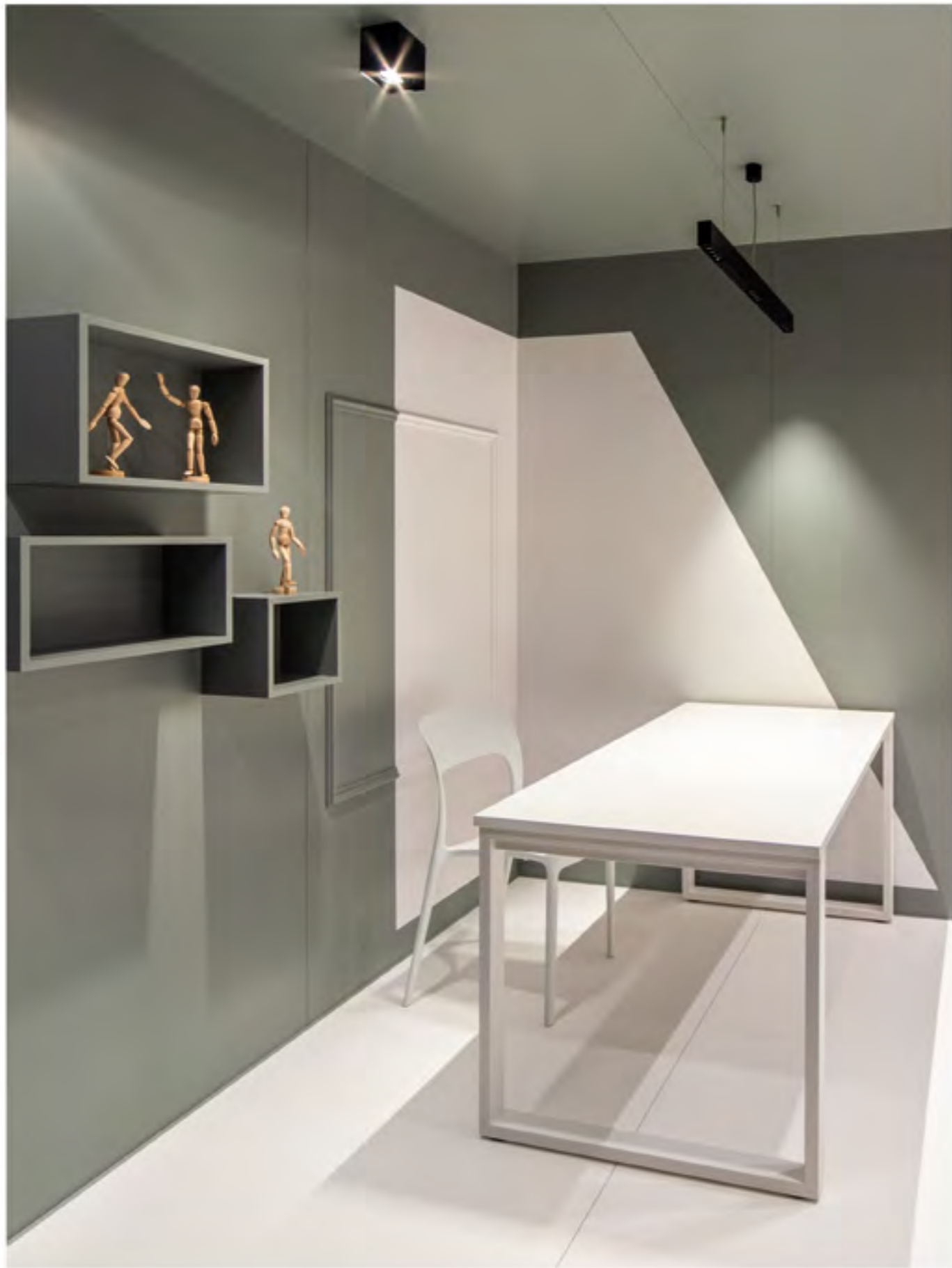

THIN TUBE



Horizontal form of THIN TUBE makes it subtle, while the best standards of efficiency are maintained. This graceful luminaire of minimalistic design is perfect both for kitchens or offices and conference rooms. Its round, petite shape guarantees visual lightness and elegance. Thanks to CRI>90, this luminaire is characterized by high colour rendering and quality of light.

Horyzontalna forma THIN TUBE nadaje oprawie lekkości oraz subtelności, zachowując przy tym najwyższe standardy wydajności. Ta smukła konstrukcja o minimalistycznym wzornictwie doskonale sprawdzi się zarówno w kuchni, jak i w biurze lub sali konferencyjnej. Jej obły, delikatny kształt gwarantuje wizualną lekkość, zachowując przy tym elegancję. Dzięki CRI>90 oprawa ta charakteryzuje się wysokim odwzorowaniem barw i najwyższą jakością światła.



luminaire family

— | [p.342](#)

■ | [p.382](#)

standard type

THIN TUBE asymmetry LED suspended

aqform.com/TT0415

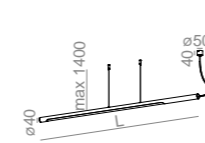

CRI>90 | 3000K | non dim

length	power	flux	cat. no
1220mm	13.0W	1820lm	50581-L930-D9-00-__
1500mm	17.5W	2430lm	50582-L930-D9-00-__
1780mm	22.0W	3040lm	50583-L930-D9-00-__

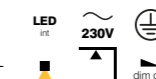

THIN TUBE central LED suspended

aqform.com/TH0315

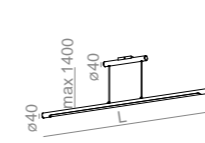

CRI>90 | 3000K | non dim

length	power	flux	cat. no
960mm	13.0W	1820lm	50572-L930-D9-00-__
1520mm	22.0W	3040lm	50571-L930-D9-00-__

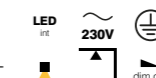

finishes

standard matt structure

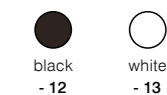

additional

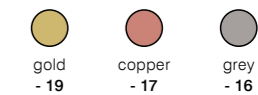

additional gloss

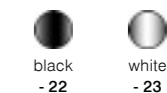

all versions

Configure your product using the fold-out or our website.

LED integrated

power:

THIN TUBE asymmetry LED suspended

1220mm — 13.0W | 26.0W

1500mm — 17.5W | 35.0W

1780mm — 22.0W | 43.5W

THIN TUBE central LED suspended

960mm — 13.0W | 26.0W

1520mm — 22.0W | 43.5W

CRI: CRI>90















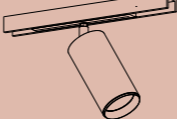
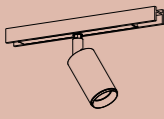
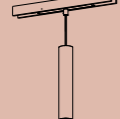
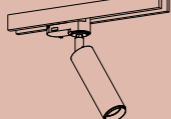
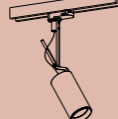
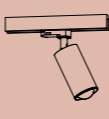

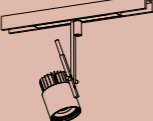
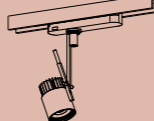

CCT: 2700 | 3000K | 4000K

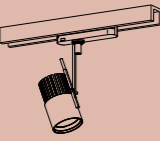

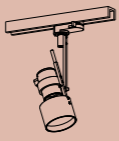



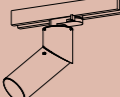
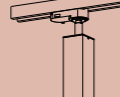

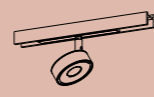
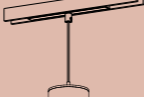

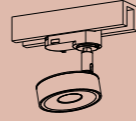

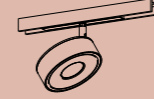
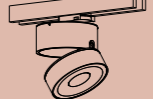



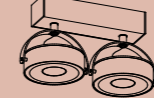
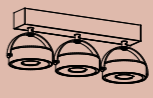
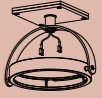

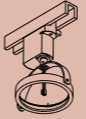
dimming optional: DALI | switchDIM

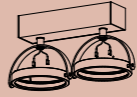
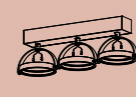
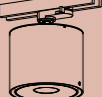

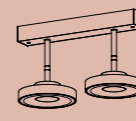
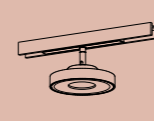
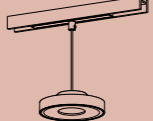
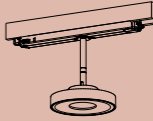
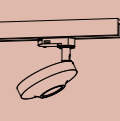
SPOT

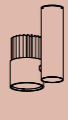
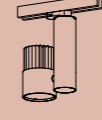
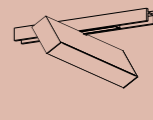
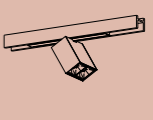
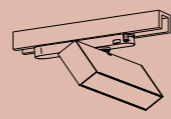
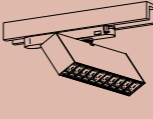
SPOTLIGHTS

PET next mini p. 228  new	PET next p. 228  new	PET next maxi p. 228  new	PETPOT next mini p. 228  new	PETPOT next p. 228  new	PET next multitrack p. 230  new
PET next mini multitrack p. 230  new	PET next mini suspended multitrack - p. 230  new	PET next mini track p. 230  new	PET next track p. 230  new	PETPOT next track p. 230  new	PET zoom track p. 232  new
PETPOT zoom p. 232  new	PETPOT zoom track p. 232  new	1000 PRO p. 236  new	1000 PRO multitrack p. 236  new	1000 PRO track p. 236  new	2000 PRO p. 238  new
2000 PRO multitrack p. 238  new	2000 PRO track p. 238  new	2000 P20 p. 240  new	2000 P20 track p. 240  new	2000 P30 p. 240  new	2000 P30 track p. 240  new
ROTT0 p. 244  new	ROTT0 track p. 244  new	QUPET mini track p. 246  new	QRLED mini p. 248  new	QRLED mini multitrack p. 248  new	QRLED mini suspended multitrack - p. 248  new

QRLED mini track p. 250  new	QRLED move p. 250  new	QRLED move multitrack p. 250  new	QRLED move track p. 250  new	CERES 111 plus QRLED p. 254  new	CERES 111 QRLED p. 254  new
CERES 111 QRLED track p. 254  new	CERES 111x1 R QRLED p. 254  new	CERES 111x2 R QRLED p. 254  new	CERES 111x3 R QRLED p. 254  new	CERES 111 p. 256  new	CERES 111 plus p. 256  new
CERES 111 track p. 256  new	CERES 111x1 R p. 256  new	CERES 111x2 R p. 256  new	CERES 111x3 R p. 256  new	TUBA 111 QRLED track p. 258  new	TUBA 111 track p. 258  new
KARI p. 260  new	KARI 17x2 p. 260  new	KARI 11 multitrack p. 260  new	KARI suspended multitrack p. 260  new	KARI track p. 260  new	AQLED lens track p. 264  new
AQLED move lens p. 264  new	AQLED move p. 264  new	ROLL simple p. 266  new	ROLL simple track p. 266  new	RAFTER 29 multitrack p. 268  new	RAFTER points multitrack p. 268  new
RAFTER track p. 268  new	RAFTER points track p. 268  new	SET TRU mini multitrack p. 272  new	SET TRU PRO mini multitrack p. 272  new	SET TRU mini points multitrack p. 272  new	system TRACK / MULTITRACK p. 274  new

PET next

new





A carefully selected detail is the best supplement to a refined composition. The new generation of PET luminaires brings the possibility of polishing interior details to the next level. The option of adjusting the colour of the reflector ring allows you to personalize the fixture. The combination of gold and black gives a glamour effect, the version combining white and black – a timeless elegance, and a single-coloured luminaire – a balanced harmony. Detail contributes to the whole, so it's worth taking care of. What colour combination will work best in your next project?

Starannie dobrany detal jest najlepszym uzupełnieniem dopracowanej kompozycji. Nowa generacja opraw PET przenosi możliwość doszlifowania szczegółów wnętrza na kolejny poziom. Opcja dostosowania koloru pierścienia wykańczającego reflektor umożliwia spersonalizowanie charakteru oprawy. Zestawienie złotego z czarnym daje efekt glamour, wersja łącząca biel i czerń – ponadczasową elegancję, a jednokolorowa oprawa – wyważoną harmonię. Detal współtworzy całość, dlatego warto o niego zadbać. Jakie połączenie kolorystyczne najlepiej sprawdzi się w najbliższym projekcie?



luminaire family

-  [p.106](#)
-  [p.174](#)
-  [p.392](#)
-  [p.362](#)

standard type

PET next mini LED spot

aqform.com/PE1811

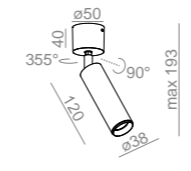

CRI>90 | 3000K | 36° | non dim

power	flux	cat. no
4.5W	520lm	16359-M930-F1-00-__

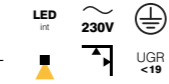

PET next LED spot

aqform.com/PP0811

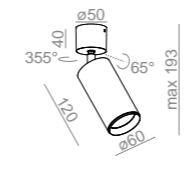

CRI>90 | 3000K | 35° | non dim

power	flux	cat. no
8.5W	1170lm	16363-M930-F1-00-__

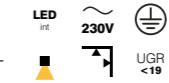

PET next maxi LED spot

aqform.com/PE2811

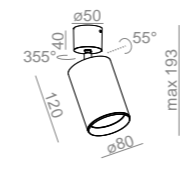

CRI>90 | 3000K | 32° | non dim

power	flux	cat. no
11.5W	1680lm	16371-L930-F1-00-__
17.0W	2330lm	16371-M930-F1-00-__



PETPOT next mini LED spot

aqform.com/PP1811

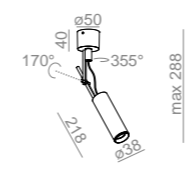

CRI>90 | 3000K | 36° | non dim

power	flux	cat. no
4.5W	520lm	16360-M930-F1-00-__



PETPOT next LED spot

aqform.com/PP2811

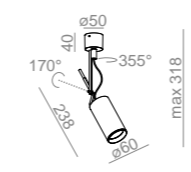

CRI>90 | 3000K | 35° | non dim

power	flux	cat. no
8.5W	1170lm	16364-M930-F1-00-__



finishes

standard matt structure



additional



additional multicolour



all versions

Configure your product using the fold-out or our website.

LED integrated

- power: dependent on version
- CRI: CRI>90
- CCT: 2700K | 3000K | 4000K
- beam angle: 20° | 36° —
- PET next mini LED spot
- PETPOT next mini LED spot
- 18° | 35° —
- PET next LED spot
- PETPOT next LED spot
- 19° | 32° —
- PET next maxi LED spot

PET next

new



Fixtures from PET family can successfully complement any project. The new generation – PET next – does it even better. Unified design with three diameters simplifies caring for aesthetics. The decorative ring also increases the shielding angle and, thanks to the possibility of choosing its finish, allows you to adapt the character of the fixture to the needs of the project. More powerful variants (up to 17W) and many mounting methods allow you to adjust the parameters of the luminaire ideally to the tasks which it has to perform. Thanks to hybrid optics, all this happens with increased comfort and efficiency.

Rodzina opraw PET z powrotem może uzupełnić niemal każdy projekt. Nowa generacja – PET next – robi to jeszcze lepiej. Ujednolicony design z trzema średnicami ułatwia dbałość o estetykę. Ozdobny pierścień ułatwia dbałość o estetykę. Ozdobny pierścień równocześnie zwiększa kąt ochrony, a możliwość wyboru jego wykończenia, pozwala dopasować charakter oprawy do potrzeb projektu. Więcej wariantów mocy (nawet do 17W) i wiele sposobów montażu umożliwiają dostosowanie parametrów oprawy idealnie do zadań, w jakich ma się sprawdzić. Dzięki hybrydowej optyce wszystko to dzieje się przy zwiększonym komforcie i wydajności.



luminaire family

-  [p.106](#)
-  [p.174](#)
-  [p.392](#)
-  [p.362](#)

standard type

PET next LED multitrack

aqform.com/PE0817

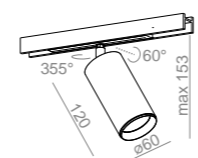

CRI>90 | 3000K | 35° | non dim
power **flux** **cat. no**
 8.5W 1170lm 16366-M930-F1-00-__

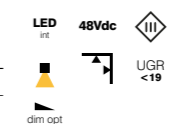

PET next mini 7x1 LED multitrack

aqform.com/PE3817

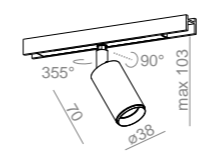

CRI>90 | 3000K | 36° | non dim
power **flux** **cat. no**
 4.5W 520lm 16367-M930-F1-00-__

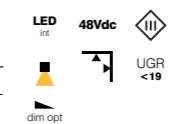

PET next mini LED suspended multitrack

aqform.com/PE1817

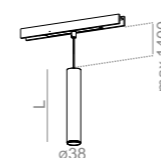

CRI>90 | 3000K | 36° | non dim
length **power** **flux** **cat. no**
 70mm 4.5W 520lm 16368-M930-F1-00-__
 200mm 4.5W 520lm 16369-M930-F1-00-__

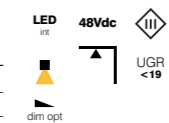

PET next mini LED track

aqform.com/PE1816

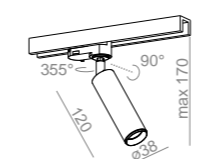

CRI>90 | 3000K | 36° | non dim
power **flux** **cat. no**
 4.5W 520lm 16358-M930-F1-00-__

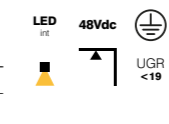

PET next LED track

aqform.com/PP0816

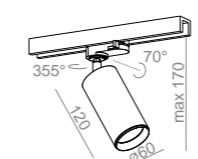

CRI>90 | 3000K | 35° | non dim
power **flux** **cat. no**
 8.5W 1170lm **QS** 16362-M930-F1-00-__

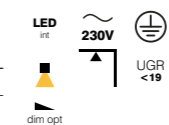

QS Q4 2020 black
QS Q4 2020 white

PETPOT next LED track

aqform.com/PP2816

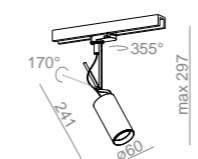

CRI>90 | 3000K | 35° | non dim
power **flux** **cat. no**
 8.5W 1170lm 16365-M930-F1-00-__

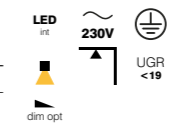

finishes

standard matt structure



additional

for multitrack on request

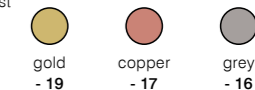

additional multicolour

for multitrack on request



all versions

Configure your product using the fold-out or our website.

LED integrated

power: dependent on version
CRI: CRI>90
CCT: 2700K | 3000K | 4000K
beam angle:

- 18° | 35° —
- PET next LED multitrack
- PET next LED track
- PETPOT next LED track
- 20° | 36° —
- PET next mini 7x1 LED multitrack
- PET next mini LED suspended multitrack
- PET next mini LED track

dimming optional:

DALI — except PET next mini LED track
 DALI (Aqsmart compatible) — all multitrack versions

available on website:

PET next maxi LED track — aqform.com/PE2816
 11.5W | 17.0W / CRI>90 / 19° | 32°
 PETPOT next mini LED track — aqform.com/PP1816
 4.5W / CRI>90 / 20° | 36°

PET zoom





Do you have an interior in which you need simultaneously a narrow beam of light to accent the selected object and a wide-angle general lighting? The size of the exposed painting has changed and now you need to adjust the beam angle? With PET luminaires, it's not a problem. Thanks to the glass lens, both functional and aesthetical element of the luminaire, you can easily change the beam angle without needing additional tools. The PET zoom beam angle can be set to one of four values: 20-26-33-41° or 22-28-36-48° for DALI version. Thanks to this, even with frequent changes, consistent lighting of display is possible.

Masz jedno wnętrze, w którym równocześnie potrzebny jest wąski snop światła do zaakcentowania wybranego obiektu i szerokokątne oświetlenie ogólne? Zmienia się rozmiar ekspozowanego obrazu i trzeba dostosować kąt świecenia? Z oprawami PET zoom to żaden problem. Dzięki szklanej soczewce, która jest równie funkcjonalnym co estetycznym elementem oprawy, łatwo można zmienić kąt świecenia bez konieczności użycia dodatkowych narzędzi. Kąt świecenia PET zoom można ustawić na jedną z czterech wartości: 20-26-33-41° lub 22-28-36-48° dla wersji ze sterowaniem DALI. Dzięki temu nawet przy częstych zmianach, spójne oświetlenie ekspozycji jest możliwe.



luminaire family

-  [p.106](#)
-  [p.174](#)
-  [p.362](#)

standard type

PET zoom LED 230V track

aqform.com/PE2116

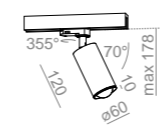

CRI>90 | 3000K | 20-41° | Phase-Control

power	flux	cat. no
8.0W	620lm	16355-M930-Z3-PH-__

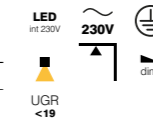

NEW

PET zoom LED DALI track

aqform.com/PE2196

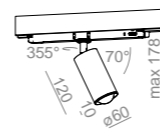

CRI>90 | 3000K | 22-48° | DALI

power	flux	cat. no
9.0W	1200lm	16330-M930-Z3-DA-__



PETPOT zoom LED 230V spot

aqform.com/PP2111

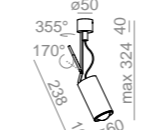

CRI>90 | 3000K | 20-41° | Phase-Control

power	flux	cat. no
8.0W	620lm	16352-M930-Z3-PH-__

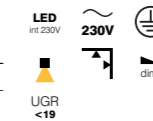

PETPOT zoom LED 230V track

aqform.com/PP2116

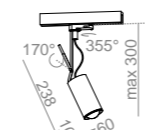

CRI>90 | 3000K | 20-41° | Phase-Control

power	flux	cat. no
8.0W	620lm	16351-M930-Z3-PH-__

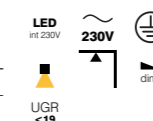

NEW

PETPOT zoom LED DALI track

aqform.com/PP2196

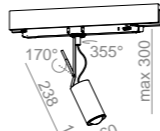

CRI>90 | 3000K | 22-48° | DALI

power	flux	cat. no
9.0W	1200lm	16331-M930-Z3-DA-__

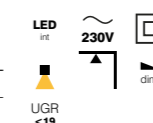

finishes

standard matt structure



additional



additional gloss



all versions

Configure your product using the fold-out or our website.

LED integrated

power: 9.0W
 CRI: CRI>90
 CCT: 2700K | 3000K | 4000K
 beam angle: 22-28-36-48°
 dimming standard: DALI

LED 230V integrated

power: 8.0W
 CRI: CRI>90
 CCT: 2700K | 3000K | 4000K
 beam angle: 20-26-33-41°
 dimming standard: Phase-Control



1000 PRO

new

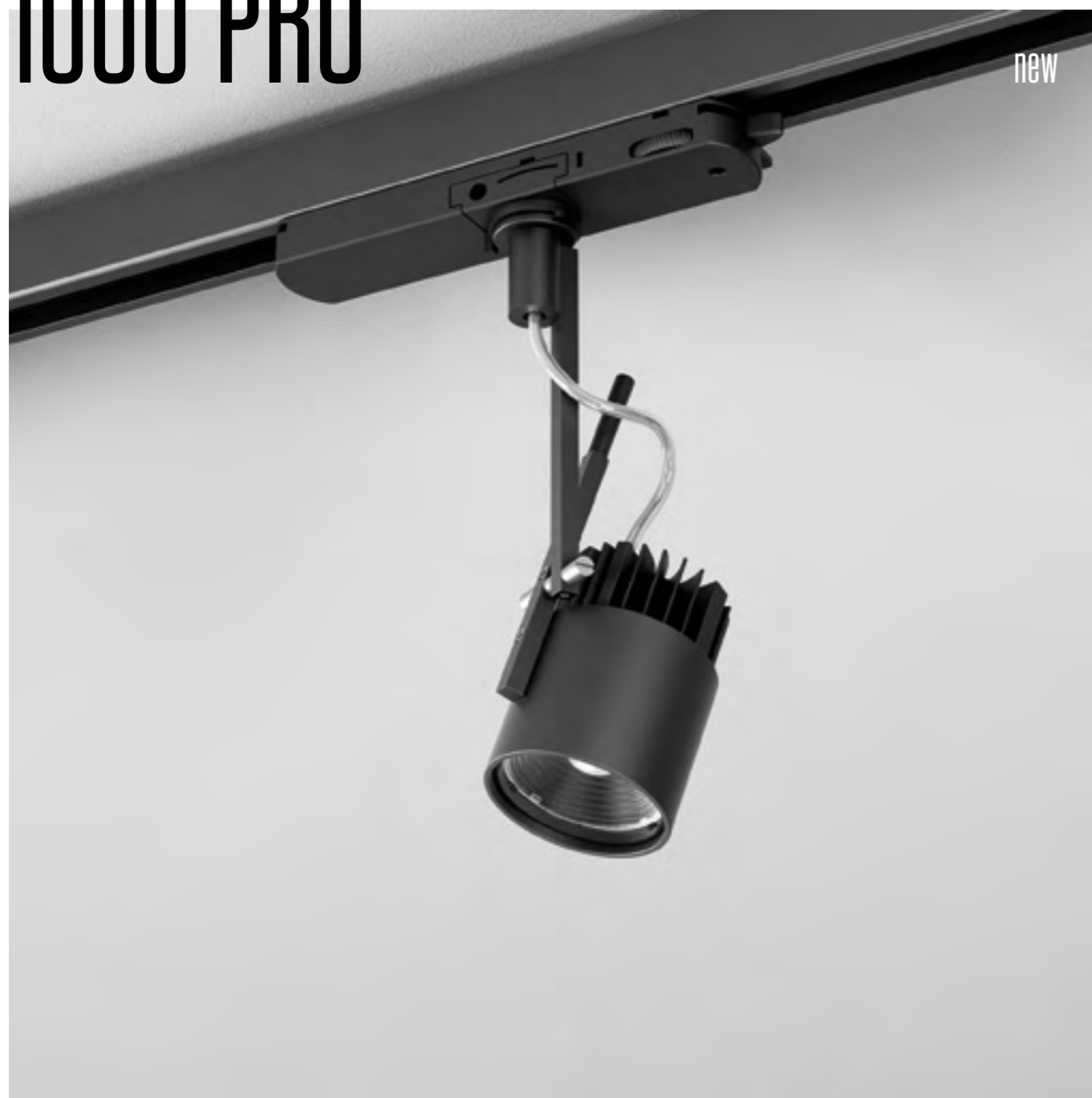

The slim 1000 PRO spotlight with small dimensions allows a transfer of the advantages of professional accent lighting with advanced optics into galleries, offices, restaurants or even to homes. Works great as accent lighting in rooms up to 3.5m high. The black reflector and recessed light source reduce glare, which ensures very high visual comfort for interior users (UGR<19 can be easily obtained). Moreover, precise optics mean that 1000 PRO light is exactly where you want it.

Zgrabny reflektor 1000 PRO o niewielkich gabarytach pozwala przenieść zalety profesjonalnego oświetlenia akcentowego o zaawansowanej optyce do galerii, biur, restauracji czy nawet do użytku domowego. Świetnie sprawdza się jako oświetlenie akcentujące w pomieszczeniach o wysokości do 3.5m. Czarny odbłyśnik i zagłębione źródło światła redukują olśnienie, co zapewnia użytkownikom wnętrza bardzo wysoki komfort wizualny (bez trudu można uzyskać UGR<19). Z kolei precyzyjna optyka powoduje, że światło 1000 PRO jest dokładnie tam, gdzie tego potrzebujemy.



standard type

1000 PRO LED spot

aqform.com/PR1011

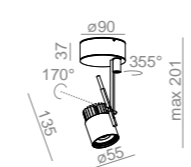

CRI>90 | 3000K | 45° | non dim

power	flux	cat. no
8.5W	1170lm	16373-M930-F1-00-__

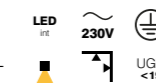

1000 PRO LED multitrack

aqform.com/PR1017

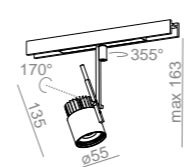

CRI>90 | 3000K | 45° | non dim

power	flux	cat. no
8.5W	1170lm	16376-M930-F1-00-__

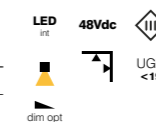

AQsmart 1000 PRO LED track

aqform.com/PR1016

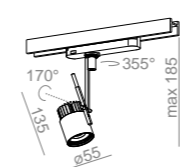

CRI>90 | 3000K | 45° | non dim

power	flux	cat. no
8.5W	1170lm	16372-M930-F1-00-__

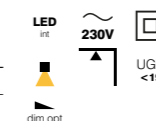

finishes

standard matt structure



additional

for multitrack on request

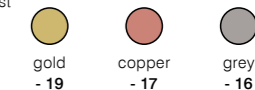

all versions

Configure your product using the fold-out or our website.

LED integrated

power: 8.5W
 CRI: CRI>90
 CCT: 2700K | 3000K | 4000K
 beam angle: 24° | 45°
 dimming optional:
 DALI | AQsmart —
 1000 PRO LED track
 DALI (AQsmart compatible) —
 1000 PRO LED multitrack

2000 PRO



2000 PRO combines precision of optics with efficiency. Carefully embedded light source and black mirror reflector guarantee visual comfort (UGR<19 can be easily obtained). Efficient LED lamp makes it possible that the illuminated objects are properly displayed, even when the fixture is mounted over 4m high. Thanks to this, 2000 PRO will perform good as office or restaurant lighting as well as professional lighting for a store or gallery. The luminaire offers two beam angles: wide – dedicated to illuminate large areas and narrow – useful for modeling with light or lighting from a distance.

2000 PRO łączy precyzję optyki z wydajnością. Starannie osadzone źródło światła oraz czarny lustrzany odbłyśnik gwarantują komfort wizualny (łatwo można uzyskać UGR<19). Wydajne źródło LED powoduje, że oświetlane obiekty są należycie wyeksponowane, nawet przy zamocowaniu oprawy na wysokości powyżej 4m. Dzięki temu 2000 PRO sprawdzi się i jako oświetlenie biura lub restauracji, i jako profesjonalne oświetlenie sklepu czy galerii. Oprawa oferuje dwa kąty świecenia: szeroki – dedykowany do oświetlania dużych powierzchni i wąski – przydatny do modelowania światłem lub oświetlania z dużej odległości.



standard type

2000 PRO LED spot

aqform.com/PR4011

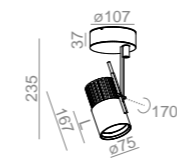

CRI>90 | 3000K | 55° | non dim

power	flux	cat. no
11.5W	1680lm	16324-L930-W1-00-__
17.0W	2330lm	16324-M930-W1-00-__
25.0W	3150lm	16324-H930-W1-00-__

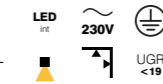

2000 PRO LED multitrack

aqform.com/PR4017

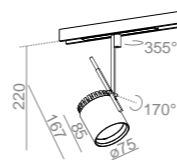

CRI>90 | 3000K | 55° | non dim

power	flux	cat. no
11.5W	1680lm	16337-L930-W1-00-__

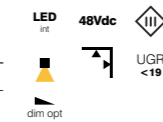

AQsmart 2000 PRO LED track

aqform.com/PR4016

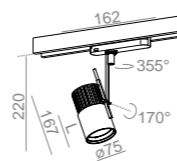

CRI>90 | 3000K | 55° | non dim

power	flux	cat. no
11.5W	1680lm	16325-L930-W1-00-__
17.0W	2330lm	16325-M930-W1-00-__
25.0W	3150lm	16325-H930-W1-00-__

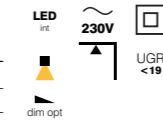

2000 PRO radiator



L power standard adapter

L power DALI adapter

M/H power standard adapter

M/H power DALI adapter

2000 PRO radiator size depends on luminaire power variant. Radiator is always black. DALI adapter for DALI track version is bigger than standard.

Rozmiar radiatora 2000 PRO zależy od wariantu mocy oprawy. Radiator jest zawsze czarny. Adapter DALI do wersji DALI track jest większy niż standardowy.

finishes

standard matt structure



additional

for multitrack on request



all versions

Configure your product using the fold-out or our website.

LED integrated

power:

2000 PRO LED spot — 11.5W | 17.0W | 25.0W

2000 PRO LED track — 11.5W | 17.0W | 25.0W

CRI: CRI>90

CCT: 2700K | 3000K | 4000K

beam angle: 20° | 55°

dimming optional:

DALI | AQsmart —

2000 PRO LED track

DALI (AQsmart compatible) —

2000 PRO LED multitrack

2000 P



The 2000 P20 and 2000 P30 collections include fixtures with replaceable light sources. Each segment of the luminaire is relevant: vertical elements allow you to easily direct light into desired direction and cylindrical shapes make convenient installation of the light source possible. Diverse dimensions of the 2000 P series allow to adjust amount and power of emitted light (P20 – maximum power 50W, P30 – maximum power 75W). Their technical character has been enriched with refined proportions. Thanks to this, the form is ideally suited to the function – it's a the quintessence of timeless solutions.

Kolekcja 2000 P20 oraz 2000 P30 to oprawy na wymienne źródła światła. Każdy ich segment odgrywa swoją rolę: pionowe elementy pozwalają łatwo kierować oprawę w wybraną stronę, a walcowate kształty umożliwiają wygodny montaż źródła światła. Zróżnicowane gabaryty serii 2000 P pozwalają zagrać ilością i mocą emitowanego światła (P20 – maksymalna moc 50W, P30 – maksymalna moc 75W). Techniczny charakter został wzbogacony o dopracowane proporcje. Dzięki temu powstała forma idealnie dopasowana do funkcji – kwintesencja ponadczasowych rozwiązań.



standard type

2000 P20 spot

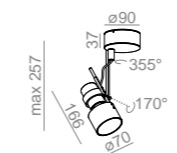

PAR20, 230V | E27 | Phase-Control

power
max: 50.0W

cat. no

10011-0000-U8-PH-__



aqform.com/10011

2000 P20 track



PAR20, 230V | E27 | Phase-Control

power
max: 50.0W

cat. no

10111-0000-U8-PH-__



aqform.com/10111

2000 P30 spot

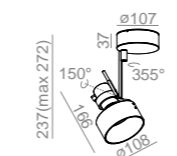

PAR30, 230V | E27 | Phase-Control

power
max: 75.0W

cat. no

10311-0000-U8-PH-__

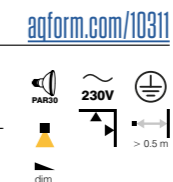

aqform.com/10311

2000 P30 track



PAR30, 230V | E27 | Phase-Control

power
max: 75.0W

cat. no

10411-0000-U8-PH-__

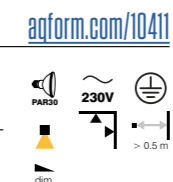

aqform.com/10411

finishes

standard matt structure

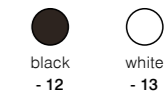

additional

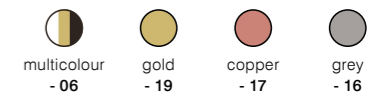

additional gloss



all versions

Configure your product using the fold-out or our website.

PAR20, 230V

power: max: 50.0W
dimming standard: Phase-Control
light source not included

PAR30, 230V

power: max: 75.0W
dimming standard: Phase-Control
light source not included

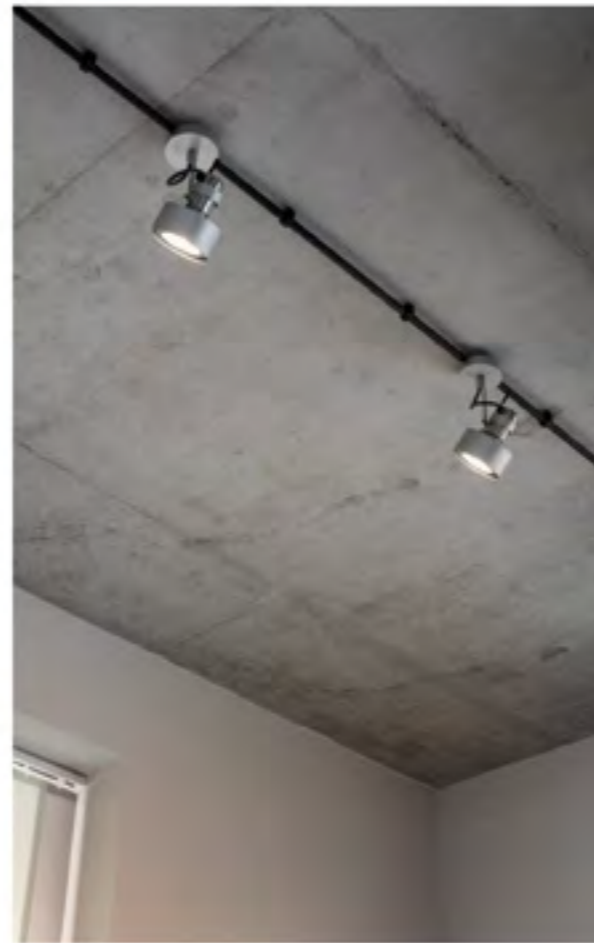

ROTTO



Kraków | lighting design: Light Project4U Joanna Raszewska-Sztorc

The ROTTO spotlight neatly conceals the possibility of movement. By turning the luminaire around its central axis, you change the direction of light. It is possible by a single hand movement, meanwhile the form of the luminaire changes its shape. These types of spotlights are a great solution for communication spaces and as accent lighting. Thanks to the expressive form, ROTTO also becomes an interior decoration. Evenly located luminaires emphasize the character of the space.

Reflektor ROTTO zgrabnie s krywa możliwość ruchu. Obracając oprawę wokół jej centralnej osi, zmieniamy kierunek padania światła. Zmiana kierunku świecenia odbywa się przy pomocy jednego ruchu ręki, równocześnie kształtując formę samej oprawy. Tego rodzaju reflektory są świetnym rozwiązaniem dla przestrzeni komunikacyjnych oraz jako oświetlenie akcentowe. Dzięki wyrazistej formie ROTTO staje się równocześnie dekoracją wnętrza. Równomiernie rozmieszczone oprawy podkreślą charakter przestrzeni.



standard type

ROTTO LED 230V spot

aqform.com/RT0071

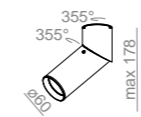

CRI>90 | 3000K | 36° | Phase-Control

power	flux	cat. no
8.0W	620lm	10043-M930-F1-PH-__

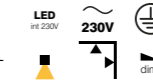

QS black
QS white

ROTTO LED 230V track

aqform.com/RT0076

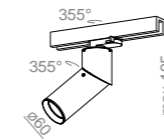

CRI>90 | 3000K | 36° | Phase-Control

power	flux	cat. no
8.0W	620lm	10044-M930-F1-PH-__



QS black

ROTTO spot

aqform.com/12991

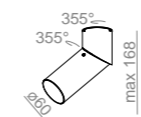

PAR16, 230V | GU10 | Phase-Control

power	cat. no
max: 35.0W	12991-0000-U8-PH-__



QS white

ROTTO track

aqform.com/16219

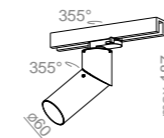

PAR16, 230V | GU10 | Phase-Control

power	cat. no
max: 35.0W	16219-0000-U8-PH-__



QS black
QS white

finishes

standard matt structure

QS from 01.2021



additional



additional gloss

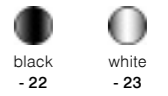

additional multicolour

for ROTTO LED 230V



all versions

Configure your product using the fold-out or our website.

LED 230V integrated

power: 8.0W
CRI: CRI>90
CCT: 2700K | 3000K | 4000K
beam angle: 24° | 36°
dimming standard: Phase-Control

PAR16, 230V

power: max: 35.0W
dimming standard: Phase-Control
light source not included

QUPET mini





Small spotlights are the perfect recipe for introducing moody spot lighting. QUPET mini works well when lighting up tall wardrobes in dressing rooms or highlighting shelves. Evenly distributed track or spot versions will fit in well in communication spaces. Small dimensions and good quality of light is a perfect combination for smaller interiors requiring light accent.

Niewielkie reflektory to idealny przepis na wprowadzenie nastrojowego oświetlenia punktowego. QUPET mini dobrze sprawdzi się jako doświetlenie wysokich szaf w garderobie czy podkreślenie półek. Równomiernie rozmieszczone wersje track dobrze pasują też do przestrzeni komunikacyjnych. Niewielkie gabaryty i dobra jakość światła to połączenie idealne dla mniejszych wnętrz wymagających akcentowania światłem.



luminaire family

-  [p.130](#)
-  [p.196](#)
-  [p.314](#)

standard type

QUPET mini LED track

aqform.com/QU1016

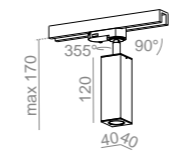

CRI>90 | 3000K | 36° | non dim

power	flux	cat. no
3.0W	380lm	10040-M930-F1-00-__

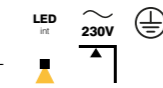

finishes

standard matt structure



additional

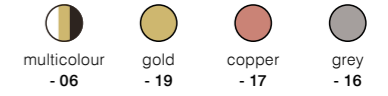

additional gloss



all versions

Configure your product using the fold-out or our website.

LED integrated

power: 3.0W
 CRI: CRI>90
 CCT: 2700K | 3000K | 4000K
 beam angle: 20° | 36°

QRLED mini



QRLED mini is just 7.5cm in diameter but offers everything we expect from a functional luminaire. Luminous flux generated by the LED diode is sufficient for most household applications. QRLED mini will bring out the texture of the wall or emphasize the beauty of your favorite plant. It will help you find a book on the shelf and help you not confuse a navy blue suit with a black one, as thanks to CRI>90 it renders colours very well. QRLED mini responds to the need for display and spot lighting at home. The subtle form means that these luminaires do not overwhelm, but emphasize the beauty of the interior in which they are located.

QRLED mini ma zaledwie 7,5cm średnicy ale oferuje wszystko, czego oczekujemy od funkcjonalnej oprawy. Generowany przez diodę LED strumień świetlny jest wystarczający do większości zastosowań domowych. QRLED mini wydobydzie teksturę ściany lub podkreśli piękno ulubionej rośliny. Pomoże znaleźć książkę na półce i nie pozwoli pomylić granatowego garnituru z czarnym, bo dzięki CRI>90 bardzo dobrze odwzorowuje barwy. QRLED mini odpowiada na potrzebę eksponowania i punktowego oświetlenia w domu. Subtelna forma powoduje, że lampy nie przytłaczają, a podkreślają urodę wnętrza, w którym się znajdują.



standard type

QRLED mini move lens 230V spot

aqform.com/QR9071

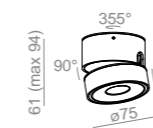

CRI>90 | 3000K | 34° | Phase-Control

power	flux	cat. no
6.0W	500lm	10048-L930-F3-PH-__
8.0W	620lm	10048-M930-F3-PH-__



QRLED mini move lens multitrack

aqform.com/QR9017

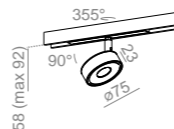

CRI>90 | 3000K | 34° | non dim

power	flux	cat. no
9.0W	1200lm	16338-M930-F3-00-__



QRLED mini lens suspended multitrack

aqform.com/QR9517

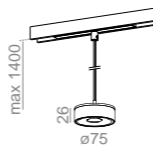

CRI>90 | 3000K | 34° | non dim

power	flux	cat. no
9.0W	1200lm	16345-M930-F3-00-__



QRLED mini move lens 230V track

aqform.com/QR9076

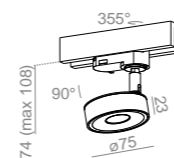

CRI>90 | 3000K | 34° | Phase-Control

power	flux	cat. no
6.0W	500lm	10049-L930-F3-PH-__
8.0W	620lm	10049-M930-F3-PH-__

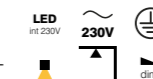

QS black
QS white

finishes

standard matt structure

QS from 01.2021



additional

for multitrack on request



additional multicolour

for multitrack on request



all versions

Configure your product using the fold-out or our website.

LED integrated

power: 9.0W
CRI: CRI>90
CCT: 2700K | 3000K | 4000K
beam angle: 34°
dimming optional: DALI (AQsmart compatible)

LED 230V integrated

power: 6.0W | 8.0W
CRI: CRI>90
CCT: 2700K | 3000K | 4000K
beam angle: 34°
dimming standard: Phase-Control

QRLED



function

QRLED is a line of integrated LED luminaires that offer extremely efficient use of power. In the constant current version at just 6W we can get close to 900lm. At 9W it is already over 1000lm – which is enough for comfortable lighting of a five-meter corridor with a height of 3m using two luminaires. In addition, this energy-saving solution is wrapped in a modern, designer form. A perfect combination.

QRLED to linia zintegrowanych opraw LED, które oferują wyjątkowo efektywne wykorzystanie mocy. W wersji stałoprądowej przy zaledwie 6W możemy otrzymać blisko 900lm. Przy 9W to już ponad 1000lm – czyli wartość wystarczająca do komfortowego oświetlenia pięciometrowego korytarza o wysokości 3m dwiema oprawami. Dodatkowo to energooszczędne rozwiązanie opakowane jest w nowoczesną, designerską formę. Idealne połączenie.

standard type

QRLED move spot

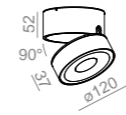

CRI>90 | 3000K | 38° | non dim

power	flux	cat. no
6.0W	880lm	12528-L930-F1-00-__
9.0W	1200lm	12528-M930-F1-00-__

aqform.com/QR8061

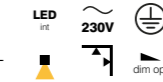

QS black, PH dim
QS white, PH dim

QRLED move multitrack

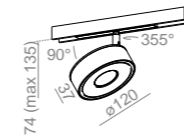

CRI>90 | 3000K | 38° | non dim

power	flux	cat. no
9.0W	1200lm	16339-M930-F1-00-__

aqform.com/QR8067

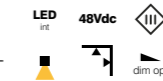

QRLED move track

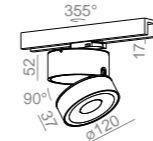

CRI>90 | 3000K | 38° | non dim

power	flux	cat. no
6.0W	880lm	12532-L930-F1-00-__
9.0W	1200lm	12532-M930-F1-00-__

aqform.com/QR8066



QRLED move 230V spot



CRI>90 | 3000K | 38° | Phase-Control

power	flux	cat. no
8.0W	620lm	12530-M930-F1-PH-__
12.0W	920lm	12530-H930-F1-PH-__

aqform.com/QR8161

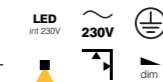

QRLED move 230V track

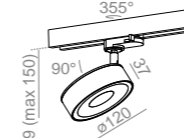

CRI>90 | 3000K | 38° | Phase-Control

power	flux	cat. no
8.0W	620lm	12534-M930-F1-PH-__
12.0W	920lm	12534-H930-F1-PH-__

aqform.com/QR8166

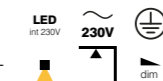

QS black
QS white

finishes

standard matt structure

QS from 01.2021



additional

for multitrack on request



additional multicolour

for multitrack on request



all versions

Configure your product using the fold-out or our website.

LED integrated

power: dependent on version

CRI: CRI>90

CCT: 2700K | 3000K | 4000K

beam angle: 38°

dimming optional:

Phase-Control —

QRLED move spot

QRLED move track

DALI —

QRLED move track

DALI (Aqsmart compatible) —

QRLED move multitrack

LED 230V integrated

power: 8.0W | 12.0W

CRI: CRI>90

CCT: 2700K | 3000K | 4000K

beam angle: 38°

dimming standard: Phase-Control

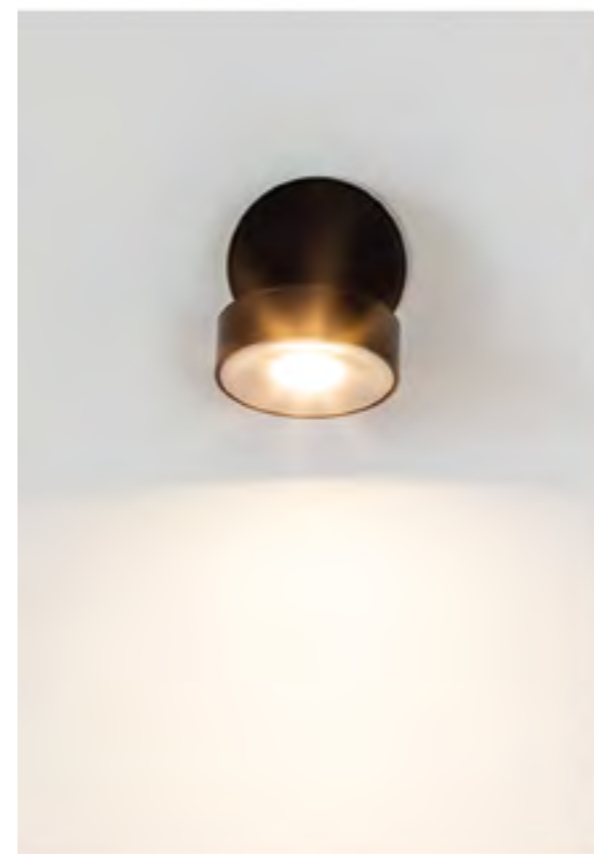

CERES QRLED



Mounted on a semicircular element, the QRLED module has the advantages of energy-saving LED light in a spatial form. A wide range of motion, a possibility of combining several luminaires on one lamp canopy (and thus powering them from one place) and isually gentle form make CERES QRLED luminaires a frequent complement to modern living rooms and refined communication spaces. They also illuminate paintings in loft offices and cafes very well.

Zamocowany na półokrągłym elemencie moduł QRLED posiada zalety energooszczędnego światła LED w przestrzennej formie. Szeroki zakres ruchu, możliwość łączenia kilku opraw na jednej podsufitce (i dzięki temu zasilenia ich z jednego miejsca) oraz wizualnie lekka forma powodują, że oprawy CERES QRLED są częstym uzupełnieniem nowoczesnych salonów, dopracowanych przestrzeni komunikacyjnych, jak również oświetlają obrazy w loftowych biurach i kawiarniach.



standard type

CERES 111 plus QRLED spot

aqform.com/CE1061

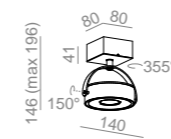

CRI>90 | 3000K | 38° | non dim

power	flux	cat. no
6.0W	880lm	12512-L930-F1-00-__
9.0W	1200lm	12512-M930-F1-00-__

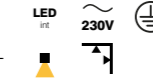

CERES 111 QRLED 230V spot

aqform.com/CE2061

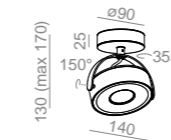

CRI>90 | 3000K | 38° | Phase-Control

power	flux	cat. no
8.0W	620lm	12516-M930-F1-PH-__
12.0W	920lm	12516-H930-F1-PH-__

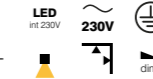

CERES 111 QRLED 230V track

aqform.com/CE2066

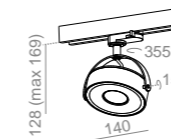

CRI>90 | 3000K | 38° | Phase-Control

power	flux	cat. no
8.0W	620lm	12520-M930-F1-PH-__
12.0W	920lm	12520-H930-F1-PH-__

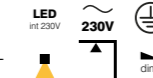

CERES 111x1 R QRLED spot

aqform.com/CE3161

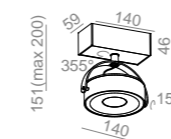

CRI>90 | 3000K | 38° | non dim

power	flux	cat. no
6.0W	880lm	12522-L930-F1-00-__
9.0W	1200lm	12522-M930-F1-00-__

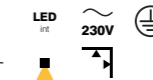

CERES 111x2 R QRLED spot

aqform.com/CE3261

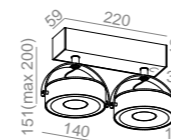

CRI>90 | 3000K | 38° | non dim

power	flux	cat. no
12.5W	1770lm	12524-L930-F1-00-__
18.0W	2410lm	12524-M930-F1-00-__

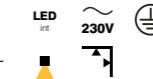

CERES 111x3 R QRLED spot

aqform.com/CE3361

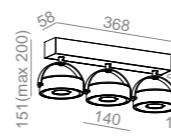

CRI>90 | 3000K | 38° | non dim

power	flux	cat. no
18.5W	2660lm	12526-L930-F1-00-__
26.5W	3620lm	12526-M930-F1-00-__

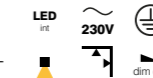

finishes

standard matt structure



additional



all versions

Configure your product using the fold-out or our website.

LED integrated

power: dependent on version
 CRI: CRI>90
 CCT: 2700K | 3000K | 4000K
 beam angle: 38°
 dimming optional:
 Phase-Control —
 CERES 111x3 R QRLED spot

LED 230V integrated

power: 8.0W | 12.0W
 CRI: CRI>90
 CCT: 2700K | 3000K | 4000K
 beam angle: 38°
 dimming standard: Phase-Control

CERES



office block BIPROSTAL S.A. | design: Dorota Oramus

In some cases, the use of replaceable light sources is justified. CERES is the perfect luminaire for them. It can power halogen and LED lamps, while meeting all compatibility and safety requirements. Several luminaire sizes allow you to always find the right version, and their look is consistent with the recessed and hanging equivalents from the AQForm offer.

W niektórych przypadkach stosowanie wymiennych źródeł światła wciąż znajduje uzasadnienie. CERES jest dla nich idealną oprawą. Potrafi zasilić lampy halogenowe i LED, spełniając przy tym wszystkie wymogi kompatybilności i bezpieczeństwa. Kilka rozmiarów oprawy pozwala zawsze znaleźć odpowiednią wersję, a wygląd jest spójny z wpuszczanymi i wiszącymi odpowiednikami z oferty AQForm.



standard type

CERES 111 spot

aqform.com/14311

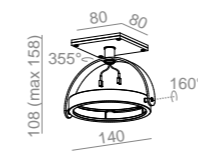

AR111, 12V AC | G53 | Phase-Control

power **cat. no**
max: 50.0W, LED 12.5W 14311-0000-T8-PH-__

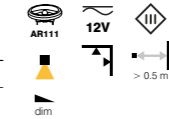

CERES 111 plus spot

aqform.com/14411

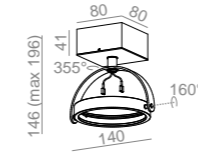

AR111, 12V AC | G53 | Phase-Control

power **cat. no**
max: 50.0W, LED 12.5W 14411-0000-T8-PH-__

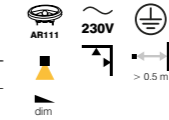

CERES 111 track

aqform.com/14511

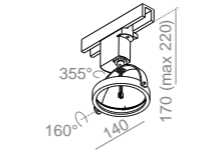

AR111, 12V AC | G53 | Phase-Control

power **cat. no**
max: 50.0W, LED 12.5W 14511-0000-T8-PH-__

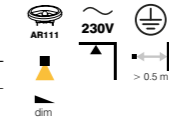

CERES 111x1 R spot

aqform.com/15611

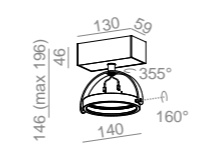

AR111, 12V AC | G53 | Phase-Control

power **cat. no**
max: 50.0W, LED 12.5W 15611-0000-T8-PH-__



CERES 111x2 R spot

aqform.com/15112

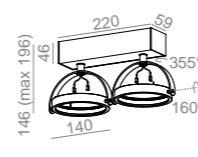

AR111, 12V AC | G53 | Phase-Control

power **cat. no**
max: 2x 50.0W, LED 12.5W 15112-0000-T8-PH-__

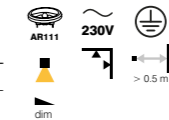

CERES 111x3 R spot

aqform.com/15213

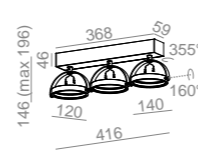

AR111, 12V AC | G53 | Phase-Control

power **cat. no**
max: 3x 50.0W, LED 12.5W 15213-0000-T8-PH-__

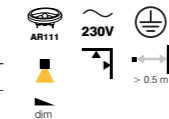

finishes

standard matt structure



additional



additional gloss

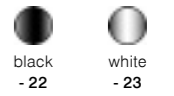

all versions

Configure your product using the fold-out or our website.

AR111, 12V AC

power: max: 50.0W, LED 12.5W
dimming: Phase-Control
light source not included
for CERES 111 spot additional gear is required

TUBA



office block „CITY”, Kraków | design: FØB!a design

One of the simplest and... most commonly modified AQForm shapes. TUBA luminaires have already enjoyed almost every RAL colour, different lengths and obtained luminous flux from less than 400lm to over 15 000lm in the most extreme versions. There is much to be said about the cylinder, but this one clearly cannot be accused of commonality.

Jeden z najprostszyc... najczęściej modyfikowanych kształtów AQForm. Oprawy TUBA przybrały już niemal każdy z kolorów palety RAL, różne długości i uzyskiwały strumienie świetlne od niespełna 400lm po przeszło 15 000lm w najbardziej ekstremalnych wersjach. O walcu można powiedzieć wiele, ale temu jednemu najwyraźniej nie sposób zarzucić spowszednienia.



luminaire family

 [p.120 / 122](#)

 [p.192](#)

 [p.320](#)

standard type

TUBA 111 QRLED track

aqform.com/TU0066

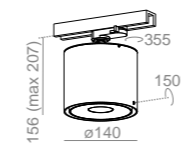

CRI>90 | 3000K | 38° | non dim

power	flux	cat. no
6.0W	880lm	12547-L930-F1-00-__
9.0W	1200lm	12547-M930-F1-00-__



TUBA 111 QRLED 230V track

aqform.com/TU0166

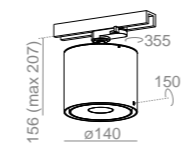

CRI>90 | 3000K | 38° | Phase-Control

power	flux	cat. no
8.0W	620lm	12546-M930-F1-PH-__
12.0W	920lm	12546-H930-F1-PH-__

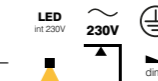

TUBA 111 track

aqform.com/16233

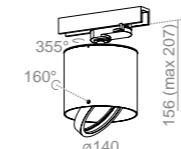

AR111, 12V AC | G53 | Phase-Control

power	cat. no
max: 35.0W, LED 12.5W	16233-0000-T8-PH-__

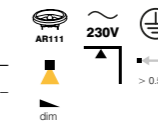

TUBA 111 230V track

aqform.com/16243

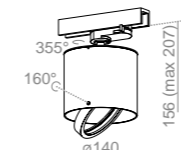

ES111, 230V | GU10 | Phase-Control

power	cat. no
max: 35.0W	16243-0000-U8-PH-__

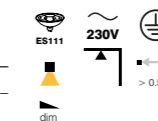

finishes

standard matt structure



additional



additional gloss



additional multicolour

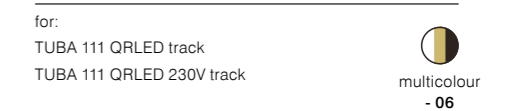

all versions

Configure your product using the fold-out or our website.

LED integrated

power: 6.0W | 9.0W
CRI: CRI>90
CCT: 2700K | 3000K | 4000K
beam angle: 38°
dimming optional: DALI | Phase-Control

LED 230V integrated

power: 8.0W | 12.0W
CRI: CRI>90
CCT: 2700K | 3000K | 4000K
beam angle: 38°
dimming standard: Phase-Control

AR111, 12V AC

power: max: 35.0W, LED 12.5W
dimming standard: Phase-Control
 light source not included

ES111, 230V

power: max: 35.0W
dimming standard: Phase-Control
 light source not included

KARI

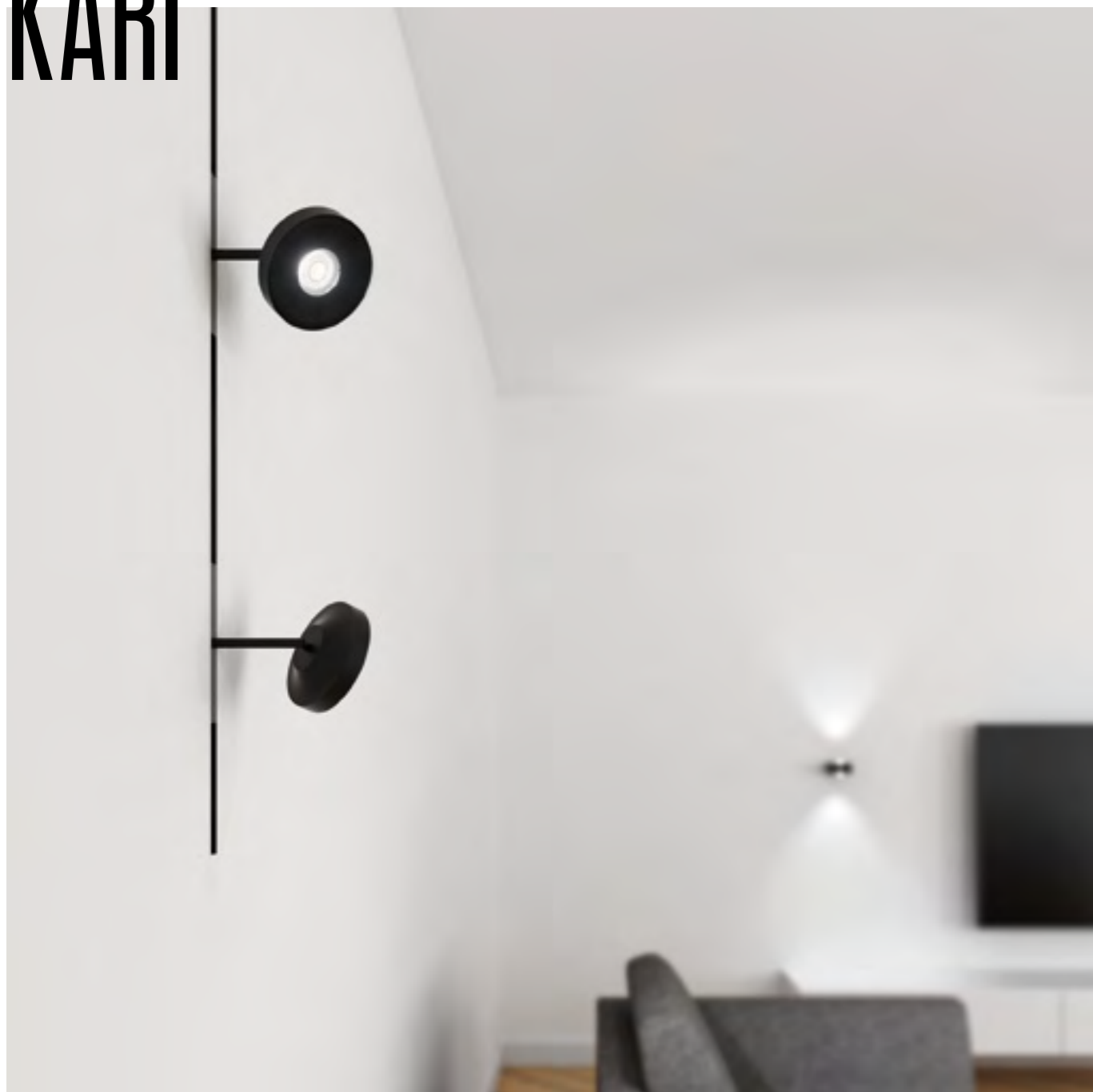



Accent lighting solutions in apartments, restaurants and offices should look good on their own. Small size of the minimalist KARI form complements such spaces very well. Delicate mechanical elements, elegant finish, balanced form – these few features make KARI an accent luminaire, which is an elegant addition itself. Thanks to this, it looks good even when mounted at eye level.

Oświetlenie akcentowe w mieszkaniach, restauracjach i biurach samo w sobie powinno dobrze wyglądać. Niewielki rozmiar minimalistycznej formy KARI dobrze uzupełnia takie przestrzenie. Delikatne elementy mechaniczne, eleganckie wykończenie, wyważona forma – tych kilka cech powoduje, że KARI to oprawa akcentowa, która sama jest eleganckim dodatkiem. Dzięki temu dobrze prezentuje się zamocowana nawet na linii wzroku.



luminaire family

-  [p.190](#)
-  [p.392](#)

standard type

KARI LED 230V spot

aqform.com/KA0071

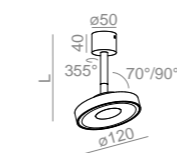

CRI>90 | 3000K | 36° | Phase-Control

length	power	flux	cat. no
110mm	8.0W	620lm	10042-M930-F1-PH-__
170mm	8.0W	620lm	10051-M930-F1-PH-__
250mm	8.0W	620lm	10053-M930-F1-PH-__

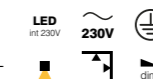

QS black
QS white

KARI 17x2 LED 230V spot

aqform.com/KA4071

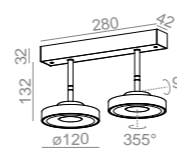

CRI>90 | 3000K | 36° | Phase-Control

power	flux	cat. no
16.0W	1240lm	16334-M930-F1-PH-__

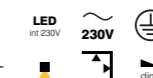

KARI 11 LED multitrack

aqform.com/KA0017

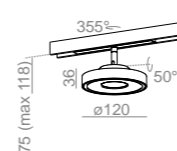

CRI>90 | 3000K | 36° | non dim

power	flux	cat. no
9.0W	1200lm	16340-M930-F1-00-__



KARI LED suspended multitrack

aqform.com/KA0517



CRI>90 | 3000K | 36° | non dim

power	flux	cat. no
9.0W	1200lm	16343-M930-F1-00-__



KARI LED 230V track

aqform.com/KA0076

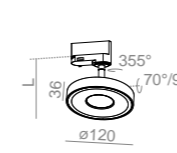

CRI>90 | 3000K | 36° | Phase-Control

length	power	flux	cat. no
110mm	8.0W	620lm	10041-M930-F1-PH-__
170mm	8.0W	620lm	10050-M930-F1-PH-__
250mm	8.0W	620lm	10052-M930-F1-PH-__

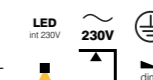

QS black
QS white

KARI LED DALI track

aqform.com/KA0096

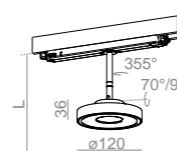

CRI>90 | 3000K | 36° | DALI

length	power	flux	cat. no
110mm	9.0W	1200lm	16327-M930-F1-DA-__
170mm	9.0W	1200lm	16328-M930-F1-DA-__
250mm	9.0W	1200lm	16329-M930-F1-DA-__

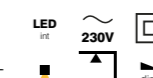

finishes

standard matt structure

QS from 01.2021

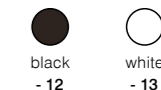

additional

for multitrack on request

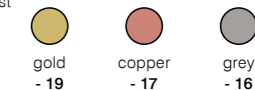

additional multicolour

for multitrack on request



all versions

Configure your product using the fold-out or our website.

LED integrated

power: 9.0W
CRI: CRI>90
CCT: 2700K | 3000K | 4000K
beam angle: 36°
dimming:
optional DALI (AQsmart compatible) —
KARI 11 LED multitrack
KARI LED suspended multitrack
standard DALI —
KARI LED DALI track

LED 230V integrated

power: dependent on version
CRI: CRI>90
CCT: 2700K | 3000K | 4000K
beam angle: 36°
dimming standard: Phase-Control



AQLED



The AQLED luminaire is distinguished by a slightly futuristic form of a truncated cone. This shape allows you to mount two types of optics that offer different lighting effects. The luminaire with a wider beam angle spotlight is well suited for general lighting, while the version with a lens performs as accent lighting in the space. Thanks to this, using one form of AQLED, you can design consistent lighting for various tasks – from general lighting to accent lighting for your favorite plant or shelf.

Oprawę AQLED wyróżnia nieco futurystyczna forma ściętego stożka. Opracowany kształt umożliwia zamocowanie dwóch rodzajów optyki, które oferują zróżnicowane efekty świetlne. Oprawa z reflektorem o szerszym kącie dobrze nadaje się do oświetlenia ogólnego, podczas gdy wersja z soczewką sprawdza się do akcentowania przestrzeni światłem. Dzięki temu, wykorzystując jedną formę AQLED, można zaprojektować spójne oświetlenie do różnych zadań – od oświetlenia ogólnego do akcentów świetlnych na ulubionej roślinie czy regale.



standard type

AQLED lens 230V track

aqform.com/AQ0146

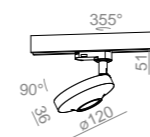

CRI>90 | 3000K | 27° | Phase-Control

power	flux	cat. no
8.0W	620lm	16357-M930-F3-PH-__

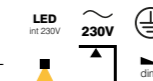

AQLED move lens 230V spot

aqform.com/AL8041

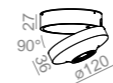

CRI>90 | 3000K | 27° | Phase-Control

power	flux	cat. no
8.0W	620lm	10028-M930-F3-PH-__

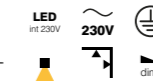

AQLED move spot

aqform.com/AL8051

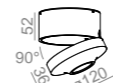

CRI>90 | 3000K | 38° | non dim

power	flux	cat. no
6.0W	880lm	10029-L930-F1-00-__
9.0W	1200lm	10029-M930-F1-00-__

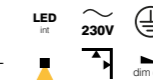

finishes

standard matt structure

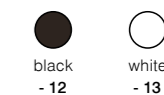

additional

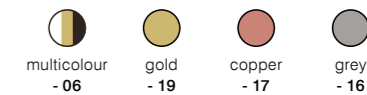

additional gloss

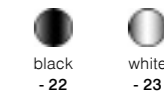

all versions

Configure your product using the fold-out or our website.

LED integrated

power: 6.0W | 9.0W
 CRI: CRI>90
 CCT: 2700K | 3000K | 4000K
 beam angle: 38°
 dimming optional: Phase-Control

LED 230V integrated

power: 8.0W
 CRI: CRI>90
 CCT: 2700K | 3000K | 4000K
 beam angle: 27°
 dimming standard: Phase-Control

ROLL

new



A wide range of motion, high power, CRI>90 and ability to control – this is what defines practical exhibition lighting. ROLL meets all these requirements. Therefore, it is a good solution primarily for shops, displays, exhibitions, and for high and large rooms. The size of the radiator depends on the chosen power variant. Optimization of the material used allowed to optimize the cost of the luminaire itself. ROLL is available in the DALI version, which lets you create advanced lighting scenes. This is especially valuable in the changing conditions of exhibition spaces.

Szeroki zakres ruchu, wysoka moc, CRI>90 oraz możliwość sterowania definiują praktyczne oświetlenie ekspozycyjne. ROLL spełnia wszystkie te wymagania. Dlatego to dobre rozwiązanie przede wszystkim do sklepów, na wystawy i ekspozycje oraz do wysokich i dużych pomieszczeń. Wielkość radiatora zależy od wybranego wariantu mocy. Optymalizacja wykorzystanego materiału pozwala zoptymalizować koszt samej oprawy. ROLL występuje w wersji DALI, która umożliwia tworzenie zaawansowanych scen świetlnych. Jest to szczególnie cenne w zmiennych warunkach przestrzeni wystawienniczych.

standard type

ROLL simple LED spot

aqform.com/RL1011

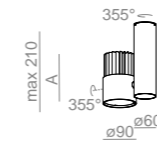

CRI>90 | 3000K | 48° | non dim

power	flux	cat. no
11.5W	1640lm	10054-L930-W1-00-__
24.0W	3140lm	10054-M930-W1-00-__
31.5W	3940lm	10054-H930-W1-00-__



AQsmart

ROLL simple LED track

aqform.com/RL1016

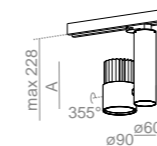

CRI>90 | 3000K | 48° | non dim

power	flux	cat. no
11.5W	1640lm	10055-L930-W1-00-__
24.0W	3140lm	10055-M930-W1-00-__
31.5W	3940lm	10055-H930-W1-00-__



ROLL simple LED DALI track

aqform.com/RL1016

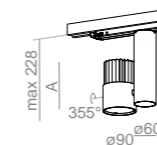

CRI>90 | 3000K | 48° | DALI

power	flux	cat. no
11.5W	1640lm	10055-L930-W1-DA-__
24.0W	3140lm	10055-M930-W1-DA-__
31.5W	3940lm	10055-H930-W1-DA-__



ROLL radiator



power L



power M



power H

ROLL radiators size depends on luminaire power variant. Radiator is always black.

Rozmiar radiatorów ROLL zależy od oprawy wariantu mocy. Radiator jest zawsze czarny.

finishes

standard matt structure



additional



all versions

Configure your product using the fold-out or our website.

LED integrated

power: 11.5W | 24.0W | 31.5W

CRI: CRI>90

CCT: 3000K | 4000K

beam angle: 48°

dimming:

optional DALI | switchDIM —

ROLL simple LED spot

optional DALI | AQsmart¹ | switchDIM —

ROLL simple LED track

standard DALI —

ROLL simple LED DALI track

¹ with AQsmart control luminaire has different adapter and 2nd protection class

RAFTER

new



RAFTER is both functionality and comfort. This family comes in two variants: with a set of recessed spotlights in the luminaire and with a cover. The version with spotlights allows to significantly reduce UGR by recessing light sources and using black, mirror finishes. It is the perfect task lighting to accentuate the space or increase the light intensity on the work surface. Moreover, softly diffused light of the version with a cover works well as general lighting. There are five mounting options: spotlight, wall lamp, suspended, surface-mounted and recessed.

RAFTER to funkcjonalność i komfort. Ta rodzina występuje w dwóch wariantach: z zestawem reflektorów zagłębionych w oprawie oraz z przesłoną. Wersja z reflektorami pozwala znacząco ograniczyć UGR dzięki cofnięciu źródeł światła i wykorzystaniu czarnych, lustrzanych wykończeń. To idealne oświetlenie zadaniowe do zaakcentowania przestrzeni lub podniesienia natężenia oświetlenia na powierzchni roboczej. Z kolei miękko rozproszone światło wersji z przesłoną dobrze sprawdza się jako oświetlenie ogólne. Dostępnych jest aż pięć opcji montażu: reflektor, kinkiet, oprawy wiszące, natynkowe oraz wpuszczane.



function

luminaire family

-  [p.094](#)
-  [p.158](#)
-  [p.216](#)
-  [p.336](#)
-  [p.422](#)

standard type

RAFTER 29 LED multitrack

aqform.com/RA0017

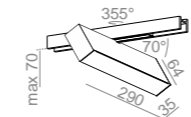

CRI>90 | 3000K | non dim

power	flux	cat. no
12.5W	1620lm	16342-M930-D9-00-__



RAFTER points LED multitrack

aqform.com/RA1017

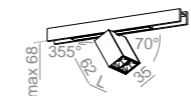

CRI>90 | 3000K | 50° | non dim

length	power	flux	cat. no
60mm	2.0W	240lm	16350-M930-W1-00-__
140mm	5.0W	610lm	16341-M930-W1-00-__

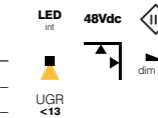

AQsmart RAFTER LED track

aqform.com/RA0016

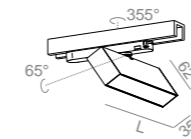

CRI>90 | 3000K | non dim

length	power	flux	cat. no
290mm	12.0W	1560lm	16335-M930-D9-00-__
430mm	18.0W	2340lm	16336-M930-D9-00-__



AQsmart RAFTER points LED track

aqform.com/RA1016

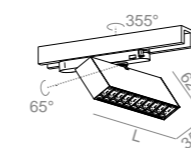

CRI>90 | 3000K | 50° | non dim

length	power	flux	cat. no
270mm	19.0W	2050lm	16323-M930-W1-00-__
400mm	28.5W	3080lm	16326-M930-W1-00-__

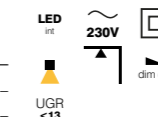

QS Q3 2020 black

finishes

standard matt structure



additional

for multitrack on request



all versions

Configure your product using the fold-out or our website.

LED integrated

- power:** dependent on version
- CRI:** CRI>90
- CCT:** 2700K | 3000K | 4000K
- beam angle:** 37° | 50° — RAFTER points
- dimming optional:** DALI (AQsmart compatible) — RAFTER 29 LED multitrack RAFTER points LED multitrack DALI | AQsmart — RAFTER LED track RAFTER points LED track



SET TRU mini

new



Most of the rooms, apart from accent lighting – which highlights selected elements – also need soft, general lighting. Such light should gently flow around the interior without causing expressive shadows. Thanks to the opal or micro-prismatic diffuser, the shapely line of SET TRU mini diffuses the light in a pleasant way. Therefore, it is a great complement to the linear MULTITRACK compositions. Moreover, versions with microprismatic optics expand the possibilities of the MULTITRACK system by task lighting for workplaces.

Większość pomieszczeń, oprócz oświetlenia akcentującego – które podkreśla wybrane elementy – potrzebuje też miękiego oświetlenia ogólnego. Takie światło powinno delikatnie opływać wnętrzu nie powodując przy tym wyrazistych cieni. Dzięki mlecznej lub mikropryzmatycznej przesłonie zgrabna linia SET TRU mini rozprasza światło w przyjemny dla oka sposób. Dlatego też jest świetnym uzupełnieniem liniowych kompozycji MULTITRACK. Z kolei wersje z mikropryzmatyczną optyką rozszerzają możliwości systemu MULTITRACK o oświetlenie zadaniowe dla miejsc pracy.

function



luminaire family

-  [p.098](#)
-  [p.164](#)
-  [p.218](#)
-  [p.332](#)
-  [p.378](#)
-  [p.416](#)

standard type

SET TRU mini LED multitrack

aqform.com/SR3017

length	power	flux	cat. no
570mm	9.0W	1000lm	16374-M930-D9-00-__
1140mm	18.5W	2010lm	16375-M930-D9-00-__

CRI>90 | 3000K | non dim

LED int 48Vdc dim opt

SET TRU PRO mini LED multitrack

aqform.com/SR3017

length	power	flux	cat. no
570mm	9.0W	1000lm	16377-M930-D5-00-__
1140mm	18.5W	2010lm	16378-M930-D5-00-__

CRI>90 | 3000K | non dim

LED int 48Vdc dim opt UGR <19

SET TRU mini points LED multitrack

aqform.com/SR3117

length	power	flux	cat. no
280mm	6.5W	800lm	16379-M930-W1-00-__
560mm	13.0W	1600lm	16380-M930-W1-00-__
840mm	19.5W	2400lm	16381-M930-W1-00-__

CRI>90 | 3000K | 68° | non dim

LED int 48Vdc dim opt

finishes

standard matt structure

-  black - 12
-  white - 13

all versions

Configure your product using the fold-out or our website.

LED integrated

power: dependent on version
 CRI: CRI>90
 CCT: 3000K | 4000K
 dimming optional:
 DALI (AQSsmart compatible)

LU TRACK

With the use of track systems, one can easily change the amount, location and even the type of luminaires installed indoors. It is possible to adjust the interior lighting without making additional changes to the ceiling structure or electrical installation. Track systems are made of aluminum profile varnished in selected colours. **The inside copper wires are placed in guideway made of self-extinguishing polycarbonate which also insulates wires from aluminium body. Fire resistance class – V0.**

Dzięki szynoprzewodom niemalże jednym ruchem można zmienić ilość, miejsce, a nawet rodzaj zamontowanych we wnętrzu opraw. Dopasowanie oświetlenia do funkcji wnętrza nie wymaga wprowadzania dodatkowych zmian w strukturze sufitu czy instalacji elektrycznej. Szynoprzewody wykonane są z profilu aluminiowego lakierowanego na wybrane kolory. **Znajdujące się w środku miedziane przewody umieszczone są w przewodnicach z samogasnącego poliwęglanu izolującego od aluminium. Klasa ognioodporności – V0.**

Nominal values / Wartości nominalne

250/400 VAC, 16 A, 50 Hz, I class

Wires / Przewody

Three phase wires (L1, L2, L3) and a neutral wire (N) – all with a cross-section of 2.5mm². The protective wire (PE) maintains the continuity and safety of the entire track system.

Trzy przewody fazowe (L1, L2, L3), przewód neutralny (N), wszystkie o przekroju 2.5mm². Przewód ochronny (PE) zachowuje ciągłość i bezpieczeństwo całego szynoprzewodu.

Finishes / Wykończenia

● alu (anodised) ● black (RAL9005) ○ white (RAL9010)¹

Mounting holes / Otwory montażowe

Mounting holes are located inside the track system every 500mm. Dimensions of the hole: 6x12mm.

Otwory montażowe znajdują się wewnątrz szynoprzewodów co 500mm. Wymiary otworu: 6x12mm.

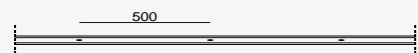

Recommended distance between all mounting brackets max. 1000mm. Zalecana odległość pomiędzy wszelkimi mocowaniami max. 1000mm.

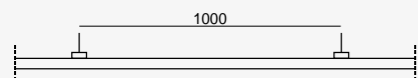

The maximum load on the track system is 30 kg/m. The maximum point load cannot be greater than 5kg.

Maksymalne obciążenie szynoprzewodu wynosi 30 kg/m.

Maksymalne punktowe obciążenie nie może być większe niż 5kg.

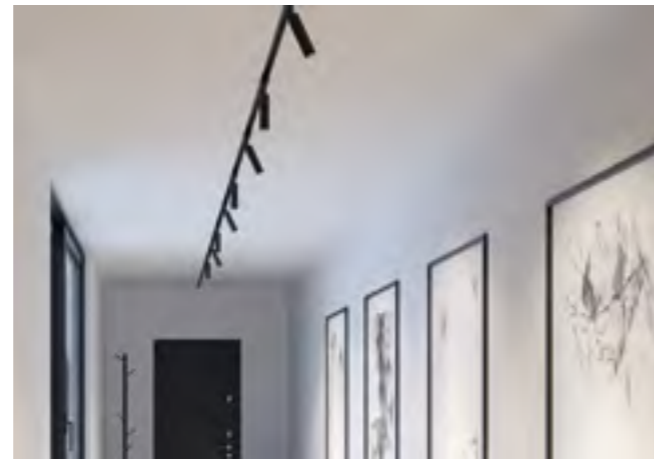
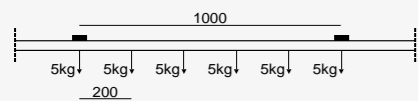

Lu Track / Szynoprzewód

recessed / wpuszczany

length	colour	3F
1000 mm	alu	T31FG-01
	black	T31FB-02
	white	T31FW-03
2000 mm	alu	T32FG-01
	black	T32FB-02
	white	T32FW-03
3000 mm	alu	T33FG-01
	black	T33FB-02
	white	T33FW-03

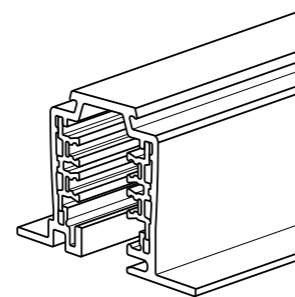

surface / suspended / natynkowy / zwieszany

length	colour	3F	3F DALI
1000 mm	alu	T31G-01	
	black	T31B-02	
	white	T31W-03	
2000 mm	alu	T32G-01	
	black	T32B-02	TC32B-02
	white	T32W-03	TC32W-03
3000 mm	alu	T33G-01	
	black	T33B-02	TC33B-02
	white	T33W-03	TC33W-03

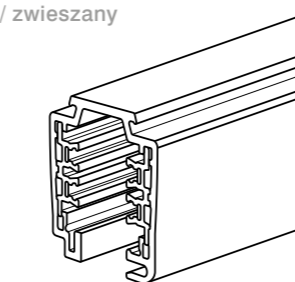

The track can be cut to given dimensions at the installation site. The cut surface or copper line of standard 3F track does not require bending or any other special treatment after the cut. Copper lines of 3F DALI track need to be trimmed after the cut.

Podczas montażu szynoprzewodu można go dociąć do odpowiedniej długości. W miejscu przecięcia standardowego szynoprzewodu 3F nie ma potrzeby zaginania ani jakiegokolwiek innej obróbki przewodów miedzianych. W szynie 3F DALI po docięciu niezbędne jest przycięcie przewodów miedzianych.

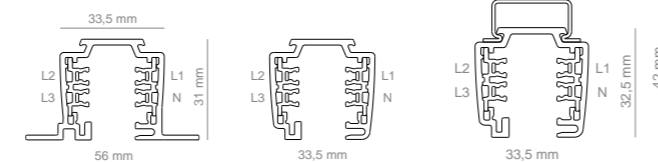

LU TRACK recessed LU TRACK surface LU TRACK suspended

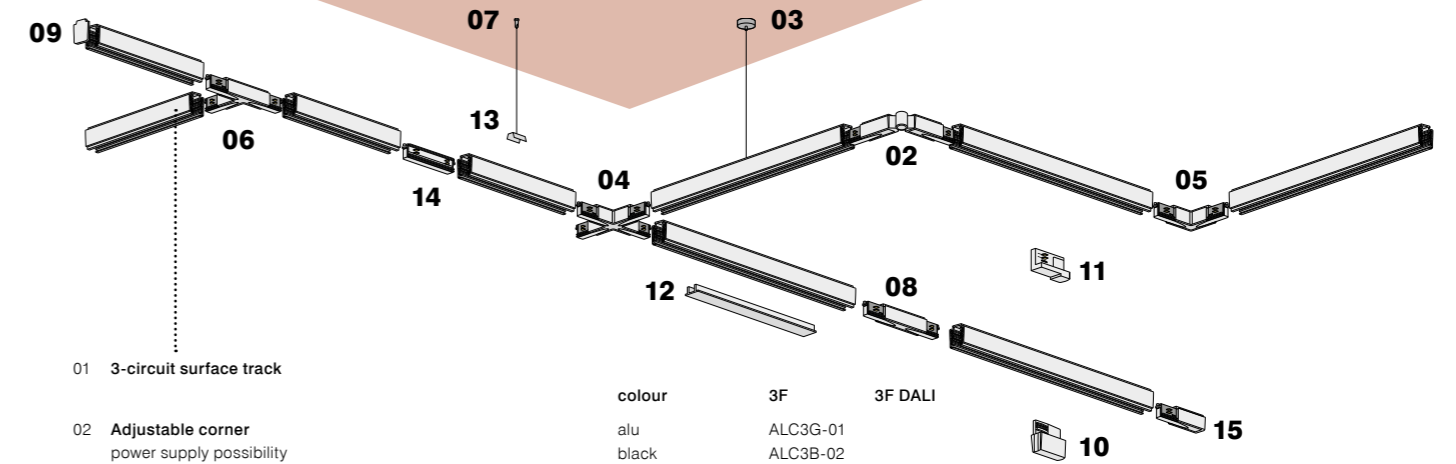

01 3-circuit surface track

02 Adjustable corner power supply possibility

03 Power feed kit power feed kit includes wire wire length: 1400mm

04 X-piece power supply possibility placement of grounding elements

05 L-corner universal power supply possibility it is possible to adjust the ground by the fitter

06 T-piece power supply possibility placement of grounding elements:

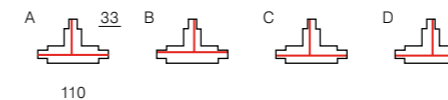

07 Wire suspension catalogue number of one wire suspension wire suspension length: 1400mm

08 Middle connection unit power supply possibility

09 End cup

10 Power take-off adapter power supply possibility

11 Adapter A75

12 Cover strip

13 Ceiling bracket

14 Middle connection unit

15 Connection unit power supply possibility placement of grounding elements:



Cover plate plastic cover plate only for recessed system it can be customized for straight and 'L', 'T', 'X' connectors

colour		3F	3F DALI
alu		ALC3G-01	
	black	ALC3B-02	
	white	ALC3W-03	
alu		90002-01	
	black	90002-02	
	white	90002-03	
alu		XA3G-01	
	black	XA3B-02	
	white	XA3W-03	
alu		LC3G-01	
	black	LC3B-02	CLC3B-02
	white	LC3W-03	CLC3W-03
black	A	TA3AG-01	
	B	TA3BG-01	
	C	TA3CG-01	
	D	TA3DG-01	
black	A	TA3AB-02	CTA3AB-02
	B	TA3BB-02	
	C	TA3CB-02	
	D	TA3DB-02	
white	A	TA3AW-03	CTA3AW-03
	B	TA3BW-03	
	C	TA3CW-03	
	D	TA3DW-03	
		90001	
alu		MCU3G-01	
	black	MCU3B-02	CMCU3B-02
	white	MCU3W-03	CMCU3W-03
alu		EC3G-01	
	black	EC3B-02	CEC3B-02
	white	EC3W-03	CEC3W-03
alu		A100G-01	
	black	A100B-02	
	white	A100W-03	
alu		1459016-01	
	black	1459016-02	
	white	1459016-03	
black		CS3B	
	white	CS3W	
	alu		CB3G-01
black		CB3B-02	
white		CB3W-03	
universal		JU3W	CJU3
alu	A	CU3AG-01	
	B	CU3BG-01	
		CU3AB-02	CCU3AB-02
black	A	CU3AB-02	
	B	CU3BB-02	
		CU3AW-03	CCU3AW-03
white	A	CU3AW-03	
	B	CU3BW-03	
		CP3G-01	
alu		CP3G-01	
	black	CP3B-02	
	white	CP3W-03	

adapter mounting

NOTE: The installation should be performed with the power OFF. UWAGA: Instalacja powinna być wykonywana przy WYŁĄCZONYM zasilaniu.

1.

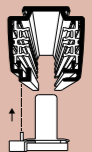

Insert the adapter properly into the track system. Włóż adapter w odpowiedni sposób do szynoprzewodu.

2.



Block the adapter by sliding the safety lock. Zablokuj adapter poprzez przesunięcie zamka zabezpieczającego.

3.



Properly installed adapter. Poprawnie zainstalowany adapter.

4.



Set the knob to the correct position. Ustaw pokrętko w odpowiedniej pozycji.

Pay attention to the direction of fitting the luminaire adapter and the power adapter - incorrect placement may result in breakage of a component.

Należy zwrócić uwagę na kierunek zakładania adaptera oprawy oraz adaptera zasilającego - niewłaściwe założenie może skutkować uszkodzeniem mechanicznym lub elektrycznym.



system MULTITRACK

modern lighting tracks

Lighting tracks are a flexible solution. The possibility to supply many luminaires from one electrical point and the ease of changing their arrangement within the track provides great flexibility at the design stage. When used in interior, it gives an option to easily adapt the lighting to changing needs. The MULTITRACK safe 48V voltage allows you to create compositions within easy reach. And so, effective compositions that transfer lighting from the ceiling to the wall are now at hand.

Luminaires for the MULTITRACK system are available in two control variants: On-Off and DALI (which is also compatible with AQsmart). Thanks to that you can not only physically change the placement of lighting but also dim or set lighting scenes, even remotely.

Szynoprzewody oświetleniowe to elastyczne rozwiązanie. Możliwość zasilania wielu opraw z jednego punktu elektrycznego i łatwość zmiany ich rozmieszczenia w obrębie szyny zapewnia dużą elastyczność już na etapie projektowania. W trakcie użytkowania wnętrza – daje możliwość łatwego dostosowania oświetlenia do zmieniających się potrzeb. Bezpieczne napięcie 48V wewnątrz MULTITRACK pozwala tworzyć kompozycje nawet w zasięgu ręki. Umożliwia to tworzenie efektownych układów przenoszących oświetlenie z sufitu na ścianę.

Oprawy dedykowane do systemu MULTITRACK dostępne są w dwóch wariantach sterowania: On-Off (włącz-wyłącz) oraz DALI, który jest kompatybilny z AQsmart. Dostępność sterowania przenosi elastyczność tego systemu na kolejny poziom. Można nie tylko fizycznie zmieniać rozkład oświetlenia, ale też ściemniać czy ustawiać sceny świetlne, również zdalnie.

Track / Szynoprzewód

recessed / wpuszczany

length	colour	cat. no
1000mm	black	MTT31FB-02
2000mm	black	MTT32FB-02
1000mm	white	MTT31FW-03
2000mm	white	MTT32FW-03

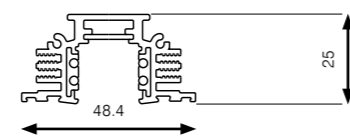

surface / natynkowy

length	colour	cat. no
1000mm	black	MTT31B-02
2000mm	black	MTT32B-02
1000mm	white	MTT31W-03
2000mm	white	MTT32W-03

suspended / zwieszany

length	colour	cat. no
1000mm	black	MTT31SB-02
2000mm	black	MTT32SB-02
1000mm	white	MTT31SW-03
2000mm	white	MTT32SW-03

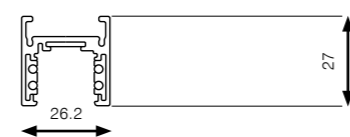

Maximum load / Maksymalne obciążenie szyny

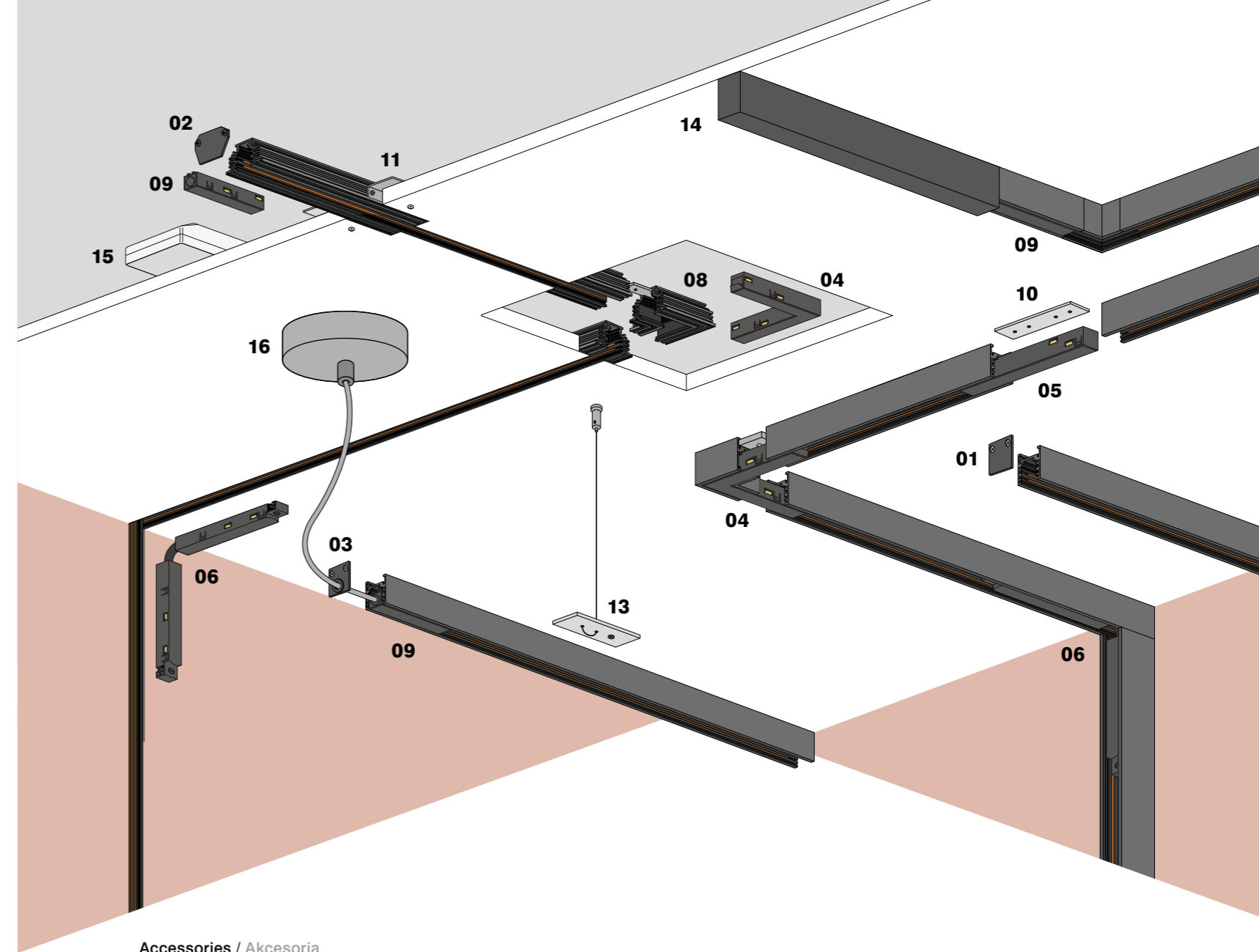
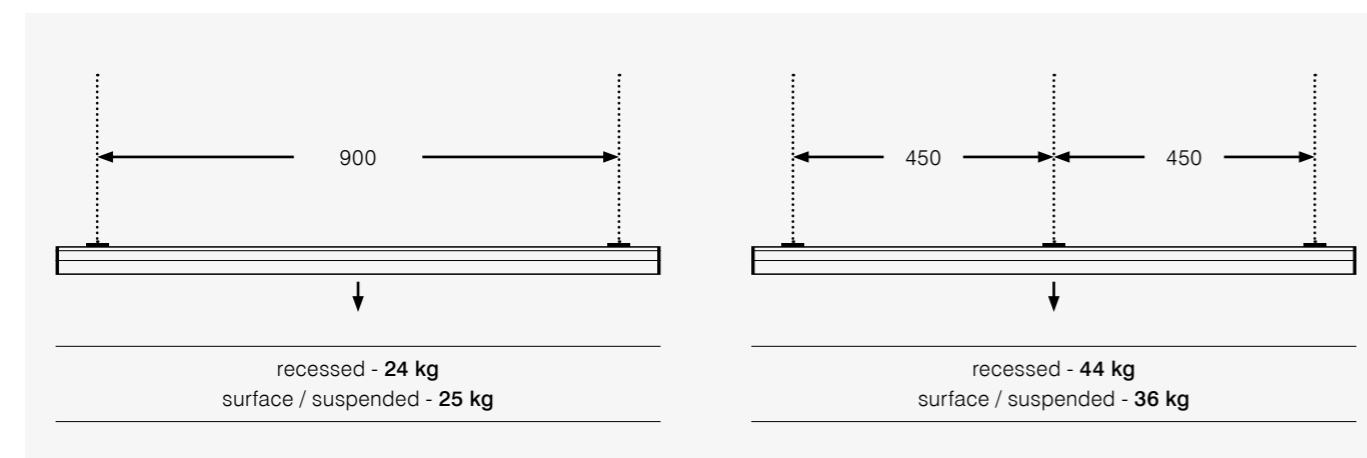

Accessories / Akcesoria

product	colour	cat. no	product	colour	cat. no
01 End cap surface/suspended	black	MTEC3B-02	09 Power supply	black	MTCU3B-02
01 End cap surface/suspended	white	MTEC3W-03	09 Power supply	white	MTCU3W-03
02 End cap recessed	black	MTEC2B-02	10 Bracket for suspensions surface/suspended		MTCB4
02 End cap recessed	white	MTEC2W-03	11 Bracket for trimless set 2pcs.		MT315
03 End cap with hole for cable surface/suspended	black	MTEC4B-02	12 Bracket for trimless use of jointing connector		MT314
03 End cap with hole for cable surface/suspended	white	MTEC4W-03	13 Suspension set 140cm suspended		81022
04 'L' corner internal	black	MTLC3B-02	14 Box with the power supply 100W 48V surface	black	81023-B
04 'L' corner internal	white	MTLC3W-03	14 Box with the power supply 100W 48V surface	white	81023-W
05 Jointing connector internal	black	MTJU3B-02	15 Power supply 60W 48V		81024
05 Jointing connector internal	white	MTJU3W-03	15 Power supply 100W 48V		81025
06 Adjustable corner internal	black	MTRGB	15 Power supply 150W 48V		81026
06 Adjustable corner internal	white	MTRGW	Power supply for DIN 120W 48V		81027
07 Cover for L joint surface/suspended	black	MTLC4B-02	16 Lamp canopy F1100 + cable 2x0.75mm ² 1.4m	black	81028-B
07 Cover for L joint surface/suspended	white	MTLC4W-03	16 Lamp canopy F1100 + cable 4x0.75mm ² 1.4m	black	81029-B
08 'L' corner recessed	black	MTLC5B-02	16 Lamp canopy F1100 + cable 2x0.75mm ² 1.4m	white	81028-W
08 'L' corner recessed	white	MTLC5W-03	16 Lamp canopy F1100 + cable 4x0.75mm ² 1.4m	white	81029-W
AQsmart AQsmart module – multitrack system can be controlled wirelessly. For wireless control AQsmart module is needed for each group of luminaires connected to the track. Regardless of AQsmart module, the luminaire must be in the DALI version.		AQSMT	Cutting tool for track conductors		81030

Connecting tracks / Łączenie szynoprzewodów

MTT3_4 FW-__1 recessed track / szynoprzewód wpuszczany

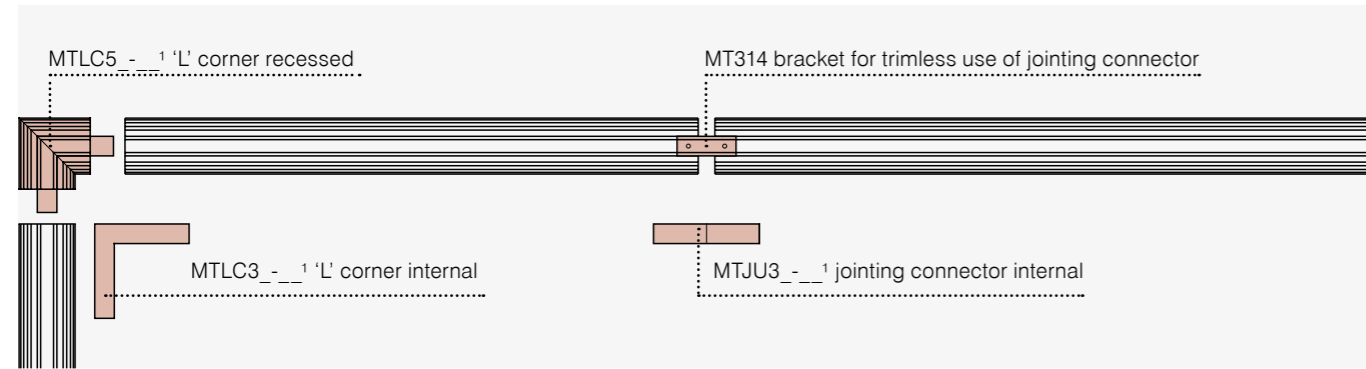

MTT3_4 W-__1 surface track / szynoprzewód natynkowy / MTT3_3 SW-__1 suspended track / szynoprzewód zwieszany

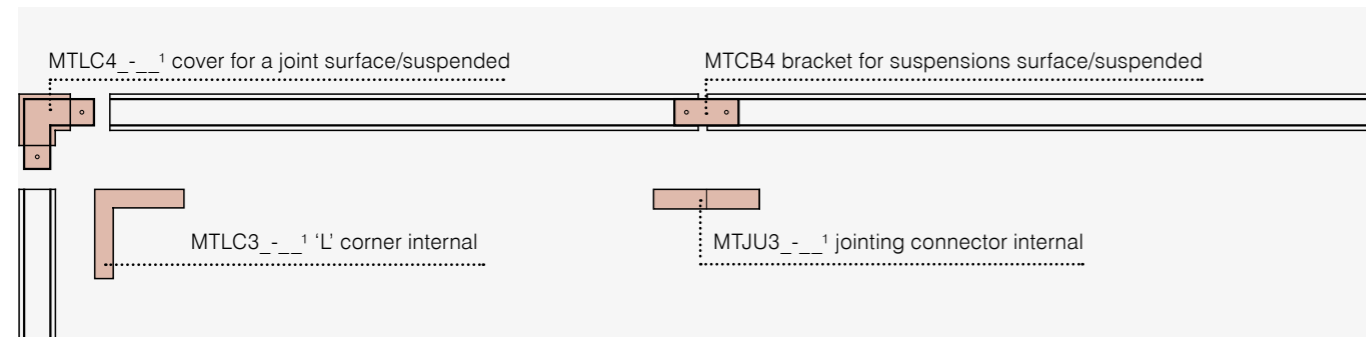

Connecting ceiling-wall transitions / Połączenia ściana-sufit

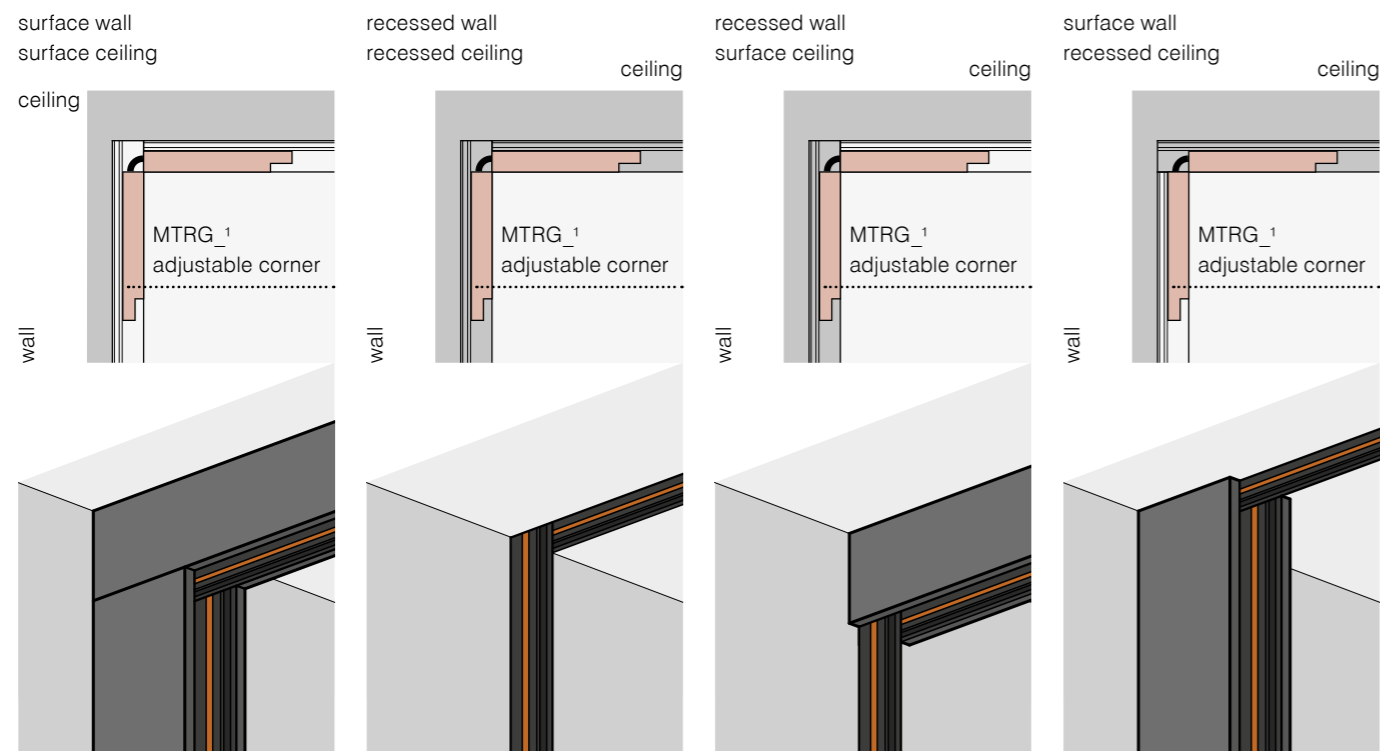

Possibilities of connecting profiles with different types of power supplies / Możliwości łączenia profili z różnymi typami zasilaczy

recessed track + recessed power supply / szynoprzewód wpuszczany + zasilacz wpuszczany

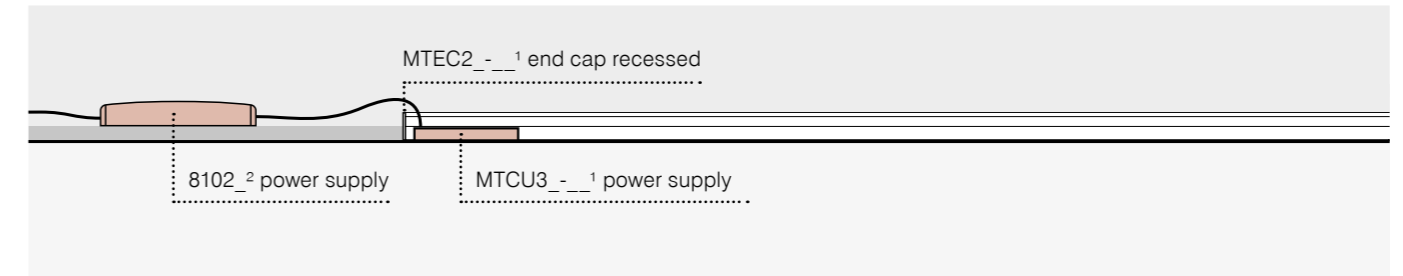

surface track + surface power supply / szynoprzewód natynkowy + zasilacz natynkowy

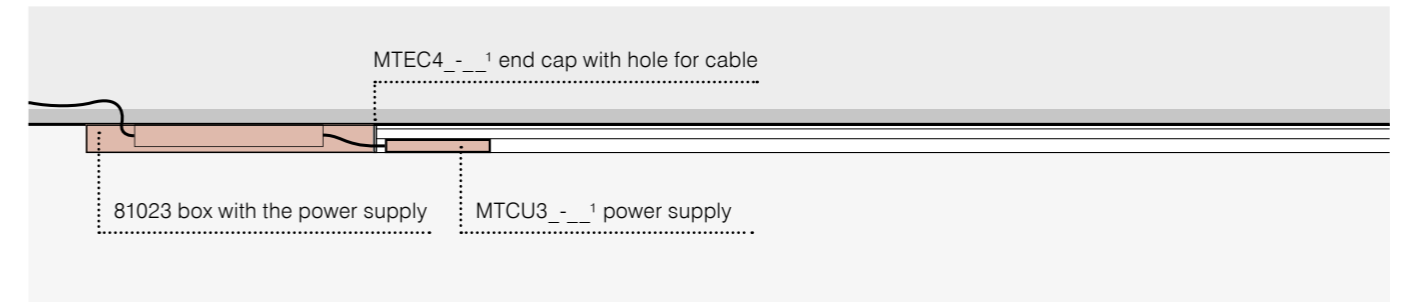

surface track + recessed power supply / szynoprzewód natynkowy + zasilacz wpuszczany

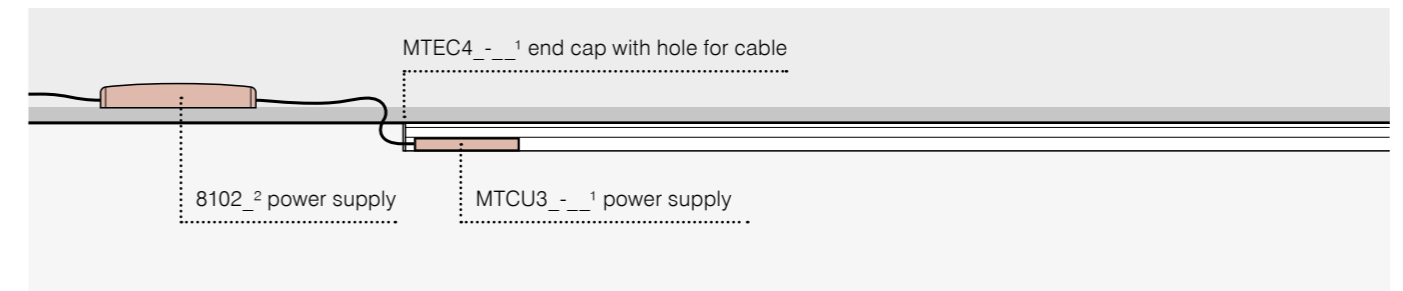

suspended track + recessed power supply / szynoprzewód zwieszany + zasilacz wpuszczany

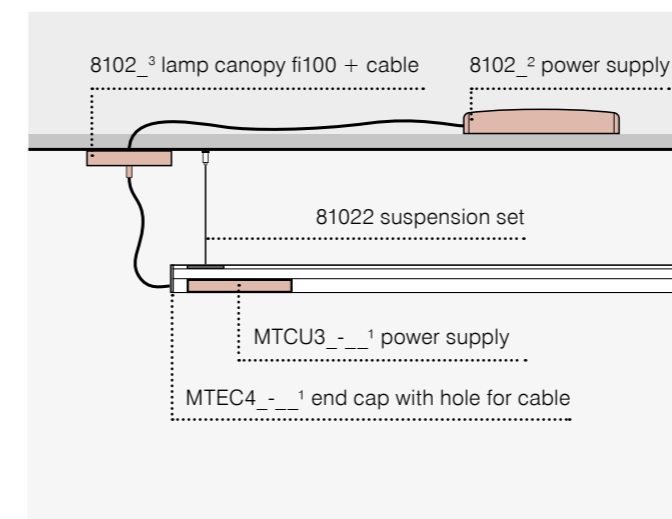

suspended track + surface power supply / szynoprzewód zwieszany + zasilacz natynkowy

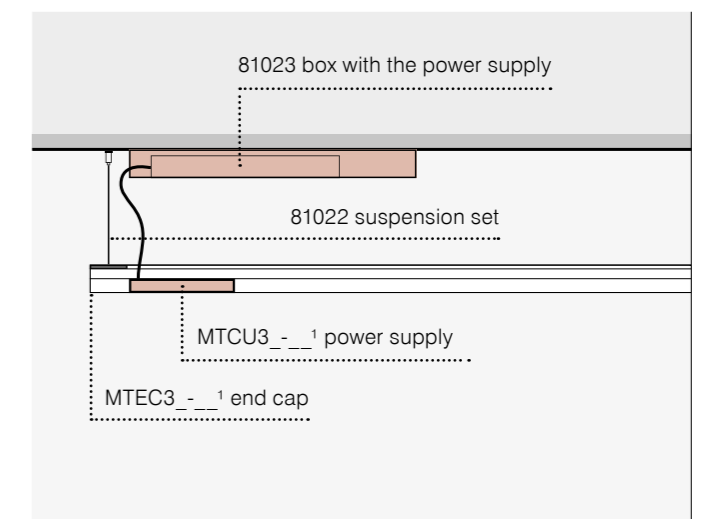

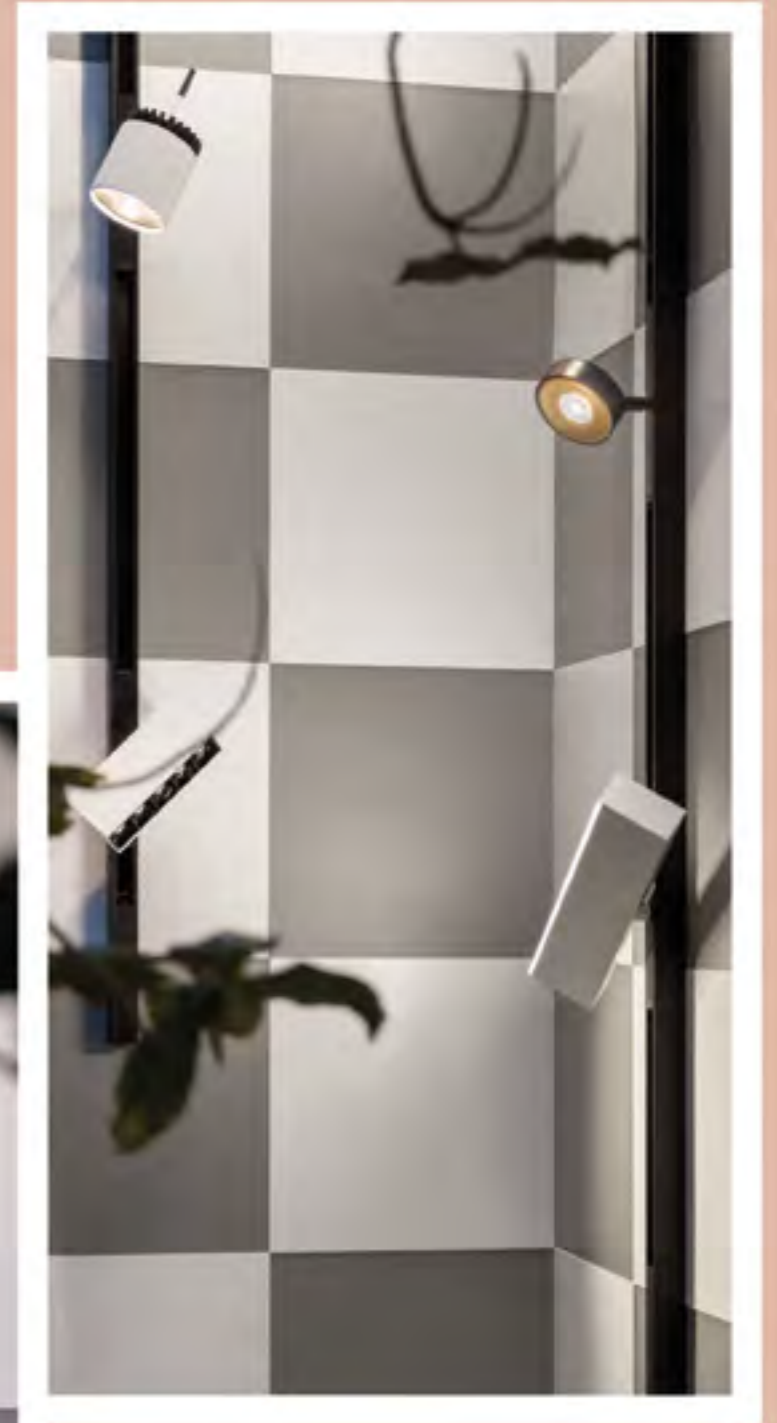

WALL

WALL

MODERN BALL
[p. 288](#)



new

MODERN BALL x2
[p. 288](#)

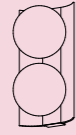

new

MODERN GLASS Tube
[p. 292](#)



GOLO
[p. 294](#)

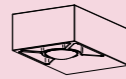

new

CAMBER mini square
[p. 298](#)



new

PET micro move
[p. 300](#)

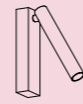

new

equilibra DIRECT 17
[p. 338](#)

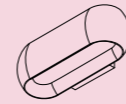

equilibra DIRECT
[p. 338](#)

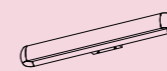

equilibra SOFT
[p. 338](#)

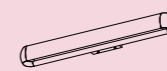

THIN TUBE
[p. 342](#)



SET RAW mini move
[p. 302](#)



new

SET RAW mini
[p. 302](#)



MAXI POINT round
[p. 306](#)

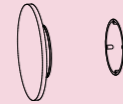

MAXI POINT square
[p. 306](#)

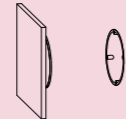

LEDPOINT round
[p. 308](#)

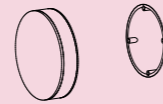

LEDPOINT square
[p. 308](#)

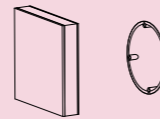

POCKET mini
[p. 312](#)

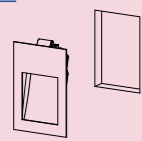

QUPET mini
[p. 314](#)



MINI CUBE
[p. 316](#)

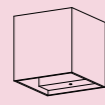

MAXI CUBE
[p. 316](#)

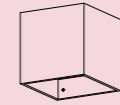

TUBA
[p. 320](#)

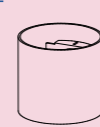

GRAPH
[p. 322](#)

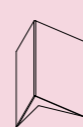

SLEEK 111x1 QRLED
[p. 324](#)

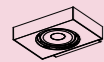

SLEEK 111x2 QRLED
[p. 324](#)

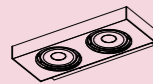

SLEEK 111x1
[p. 324](#)

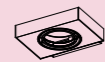

SLEEK 111x2
[p. 324](#)

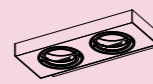

CADRA 111x1
[p. 326](#)

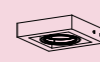

CADRA 111x2
[p. 326](#)

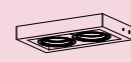

BASET
[p. 328](#)

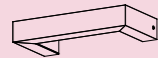

SMART PANEL GL oval
[p. 330](#)

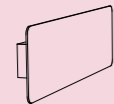

SMART PANEL GL square
[p. 330](#)

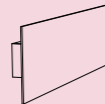

SET TRU up&down
[p. 332](#)



SET TRU
[p. 332](#)



RAFTER
[p. 336](#)



MODERN BALL

Designed in collaboration with DECHEM

new

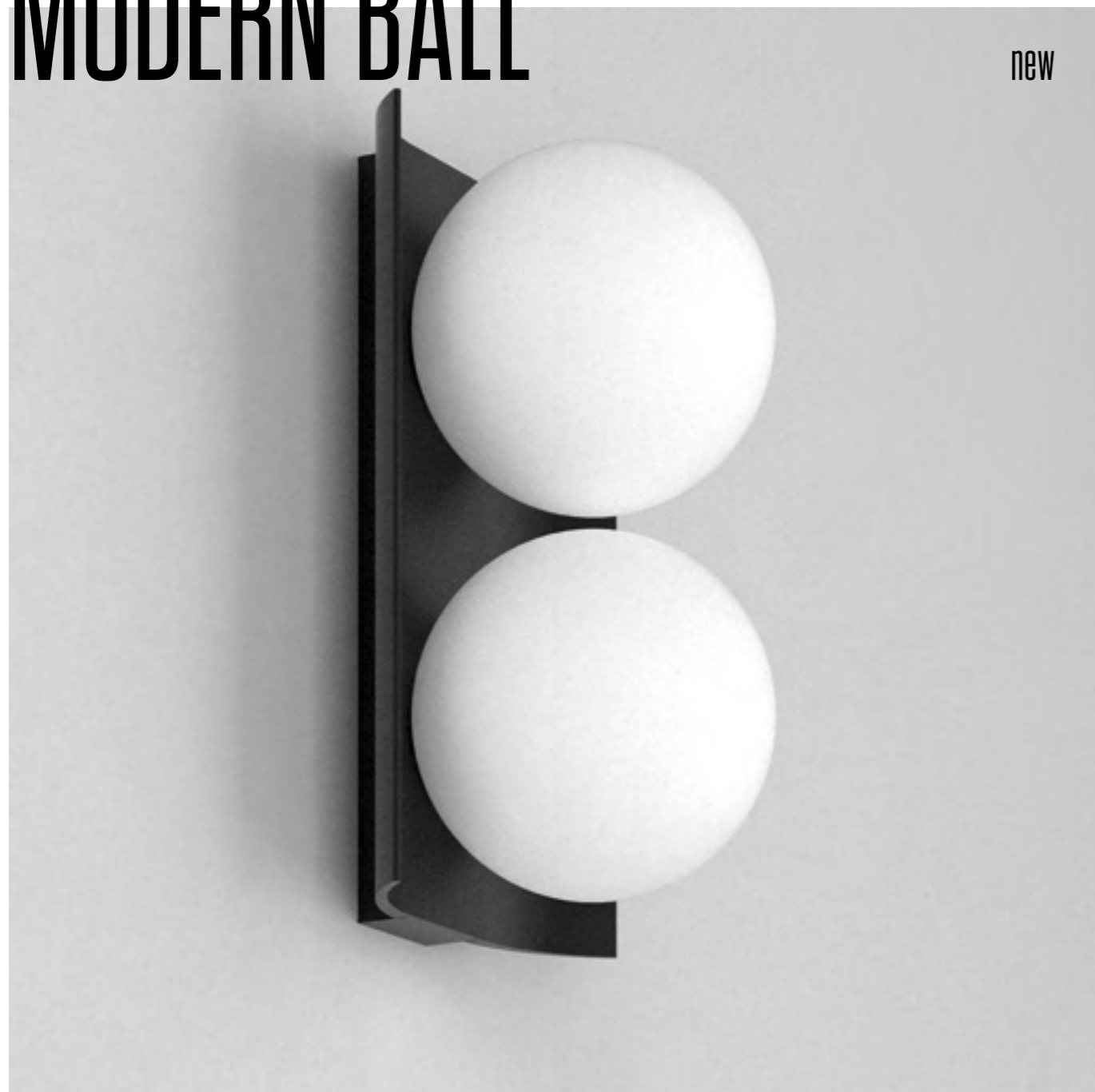

The ball is said to be the perfect shape. How about a lit ball? It is definitely a great addition to any stylish interior. Softly lit, perfect in its curves MODERN BALL combines a decorative function with comfortable lighting. Milk-glass hides an efficient source of light from the viewer's eyes. The large luminous surface helps to reduce glare. MODERN BALL luminaires mounted on the ceiling work well as general lighting, as well as mood side lighting mounted on the wall.

Mówi się, że kula to kształt doskonały. A rozświetlona kula? Zdecydowanie jest doskonałym dodatkiem do każdego stylowego wnętrza. Miętko rozświetlona, idealna w swoich krągłościach MODERN BALL łączy funkcję ozdobną z komfortowym oświetleniem. Mleczne szkło skrywa przed wzrokiem obserwatora wydajne źródło światła LED. Duża powierzchnia świecąca pomaga ograniczyć przykre oślnienie. Oprawy MODERN BALL zamocowane na suficie sprawdzają się jako oświetlenie ogólne, jak również jako klimatyczne oświetlenie boczne montowane na ścianie.



luminaire family

 [p.104](#)

 [p.170](#)

standard type

MODERN BALL WP LED surface

aqform.com/MB1014



CRI>90 | 3000K | non dim

power	flux	cat. no
6.0W	880lm	46970-L930-D0-00-__
9.0W	1200lm	46970-M930-D0-00-__

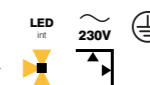

MODERN BALL WP x2 LED surface

aqform.com/MB2014

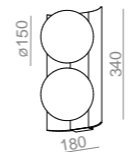

CRI>90 | 3000K | non dim

power	flux	cat. no
12.5W	1770lm	46971-L930-D0-00-__
18.0W	2410lm	46971-M930-D0-00-__

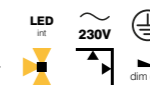

finishes

standard matt structure

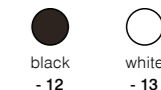

additional

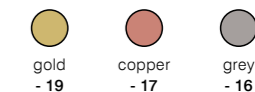

all versions

Configure your product using the fold-out or our website.

LED integrated

power: dependent on version
CRI: CRI>90
CCT: 2700K | 3000K | 4000K
dimming optional:
 DALI —
 MODERN BALL WP x2 LED surface



MODERN GLASS



Glass gracefully harmonizes with the light. That is why MODERN GLASS wall lamps are an interesting idea for decorative lighting in any room that needs some atmosphere – LED light reflects off the wall creating a pleasant atmosphere, and the glass shade is an extremely aesthetic addition. Available finishes give different visual and lighting effects: smooth lampshade (TP) transmits light and shows a minimalist interior of the luminaire, on the rhombus version (TR) the light creates more reflections, smoked lampshade (SP) gives more subtle light, and milky glass (WP) softly and evenly illuminates itself.

Szkoło wdzięcznie współgra ze światłem. Dlatego kinkiety MODERN GLASS to ciekawy pomysł na dekoracyjne oświetlenie każdego pomieszczenia, któremu potrzeba odrobiny nastroju – światło LED odbija się od ściany tworząc przyjemną atmosferę, a szklany klosz to wyjątkowo estetyczny dodatek. Dostępne wykończenia dają różne efekty wizualne i oświetleniowe: gładki klosz (TP) przepuszcza światło i ukazuje minimalistyczne wnętrze oprawy, na wersji romb (TR) światło tworzy więcej refleksów, klosz smoked (SP) daje światło bardziej subtelne, a mleczne szkło (WP) miękko i równomiernie rozświetla się w całości.



luminaire family

-  [p.110](#)  [p.392](#)
-  [p.176](#)
-  [p.352](#)

standard type

MODERN GLASS Tube TP LED 230V wall

aqform.com/MG3012

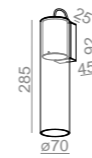

CRI>90 | 3000K | Phase-Control

power	flux	cat. no
6.0W	500lm	20233-M930-D9-PH-__

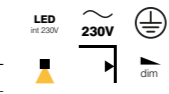

MODERN GLASS Tube SP LED 230V wall

aqform.com/MG3012

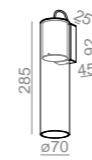

CRI>90 | 3000K | Phase-Control

power	flux	cat. no
6.0W	500lm	20235-M930-D9-PH-__

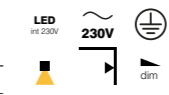

MODERN GLASS Tube TR LED 230V wall

aqform.com/MG3412

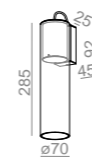

CRI>90 | 3000K | Phase-Control

power	flux	cat. no
6.0W	500lm	20234-M930-D9-PH-__

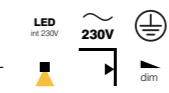

NEW MODERN GLASS Tube WP LED 230V wall

aqform.com/MG3012

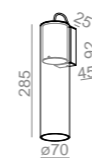

CRI>90 | 3000K | Phase-Control

power	flux	cat. no
6.0W	500lm	26496-M930-D9-PH-__

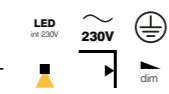

glass finishes



finishes

standard matt structure

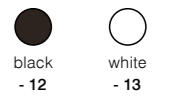

additional



all versions

Configure your product using the fold-out or our website.

LED integrated

power: 6.0W
CRI: CRI>90
CCT: 2700K | 3000K | 4000K
dimming standard: Phase-Control

GOLO

new



Compact, modern shape and expressive up and down light are the hallmarks of GOLO. This small wall lamp can single-handedly liven up a completely empty wall by 'painting' it with light. Such luminous patterns work well both on smooth surfaces where light plays a major role, and on texture walls where chiaroscuro emphasizes the three-dimensionality of their material. GOLO wall lamp can also be used as bathroom lighting due to IP44 protection class.

Kompaktowy kształt, nowoczesna bryła i ekspresyjne światło góra-dół to cechy charakterystyczne GOLO. Ten niewielki kinkiet nawet w pojedynkę potrafi ożywić całkiem pustą ścianę „malując” ją światłem. Takie świetlne wzory sprawdzają się zarówno na gładkich powierzchniach, na których światło gra główną rolę, jak i na ścianach ze strukturą, gdzie światłocien podkreśla trójwymiarowość materiału. Dzięki podwyższonej klasie szczelności IP44, kinkiet GOLO można stosować również jako oświetlenie do łazienek.



standard type

GOLO LED hermetic wall

aqform.com/GL0012

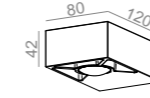

CRI>90 | 3000K | 65° | non dim

power	flux	cat. no
1.5W	180lm	26495-L930-W3-00-__
3.0W	350lm	26495-M930-W3-00-__



UGR <13

QS black

QS white

finishes

standard matt structure

QS from 01.2021



additional



all versions

Configure your product using the fold-out or our website.

LED integrated

power: dependent on version

CRI: CRI>90

CCT: 2700K | 3000K | 4000K

beam angle: 65°



CAMBER mini

new



The simple form of CAMBER means that it can be fitted into almost any interior. The location of the light source enables the lamp to lit the wall without glaring the user. This effect works both in home interiors, where it allows you to create a relaxing atmosphere, as well as in offices or restaurants – there, soft side light warms and enlivens the atmosphere. Due to its small dimensions, CAMBER works as a subtle light accent.

Dzięki prostej formie kinkiet CAMBER można wpasować w niemal dowolne wnętrze. Umieszczenie źródła światła powoduje, że lampa rozświetla ścianę nie oślepiając przy tym użytkownika. Taki efekt sprawdza się zarówno we wnętrzach domowych, gdzie pozwala stworzyć relaksacyjny klimat, jak i w biurach czy restauracjach – tam miękkie światło boczne ociepla i ożywia atmosferę. Dzięki niewielkim wymiarom, CAMBER sprawdza się jako subtelny akcent świetlny.



standard type

CAMBER square mini LED wall

aqform.com/CA1112

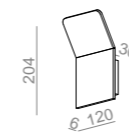

CRI>90 | 3000K | non dim

power	flux	cat. no
6.0W	880lm	26503-L930-D9-00-__

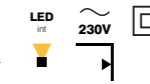

finishes

standard matt structure



additional



all versions

Configure your product using the fold-out or our website.

LED integrated

power: 6.0W

CRI: CRI>90

CCT: 2700K | 3000K | 4000K

PET micro

new



Luminaires with focused light, which can be directed in the desired direction, work well as reading lights at the bedside or favorite armchair. Especially if steering is reachable by hand and the luminaire is small. That's exactly what PET micro wall is like. It will light the page of the book, but thanks to its precise optics it will not light up too much the surrounding space.

Oprawy ze światłem skupionym, które można skierować w wybranym kierunku, dobrze sprawdzają się jako oświetlenie do czytania, szczególnie przy łóżku. Zwłaszcza, jeżeli kierowanie jest dostępne na wyciągnięcie ręki, a oprawa ma niewielki rozmiar. Właśnie taki jest PET micro wall. Dobrze oświetli stronę książki, a dzięki precyzyjnej optyce nie rozświetli zanadto przestrzeni wokół.



standard type

PET micro move LED wall

aqform.com/PE2012

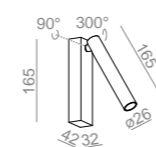

CRI>90 | 3000K | 32° | non dim

power	flux	cat. no
2.0W	130lm	26504-M930-F3-00-__

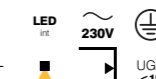

QS Q4 2020 white

finishes

standard matt structure



additional

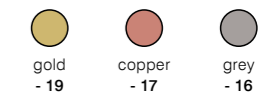

all versions

Configure your product using the fold-out or our website.

LED integrated

power: 2.0W
 CRI: CRI>90
 CCT: 2700K | 3000K
 beam angle: 32°

SET RAW mini

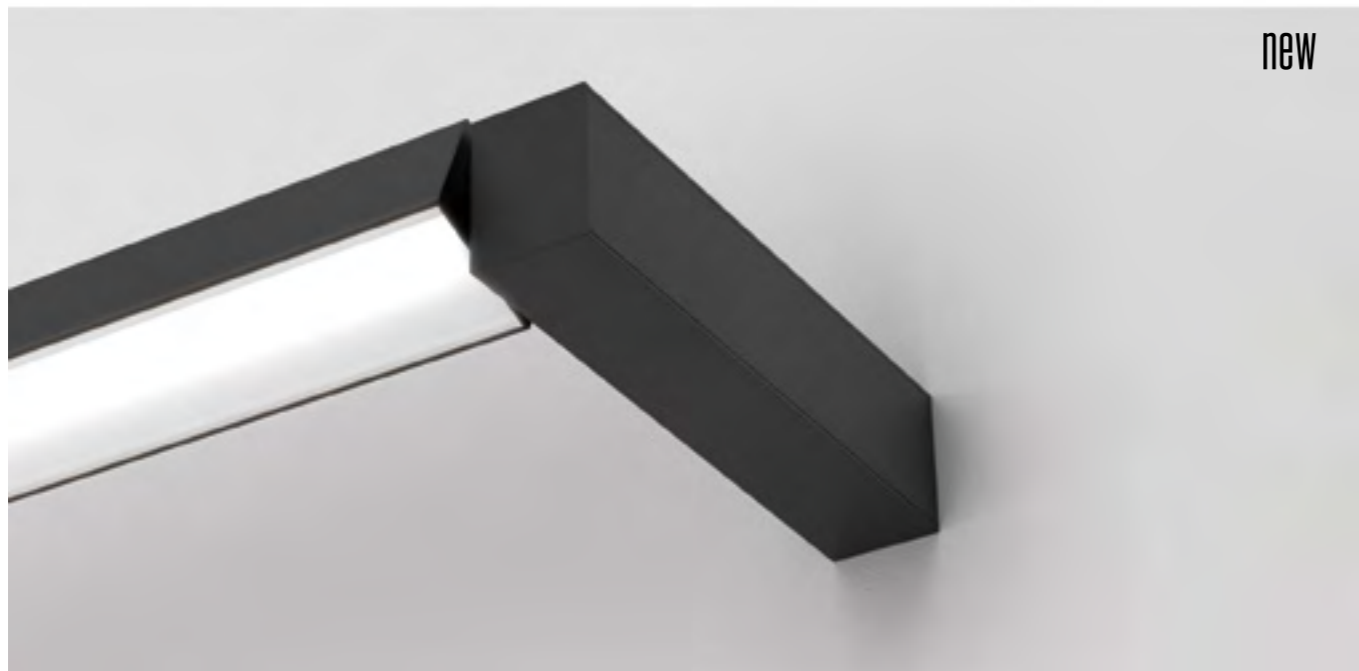
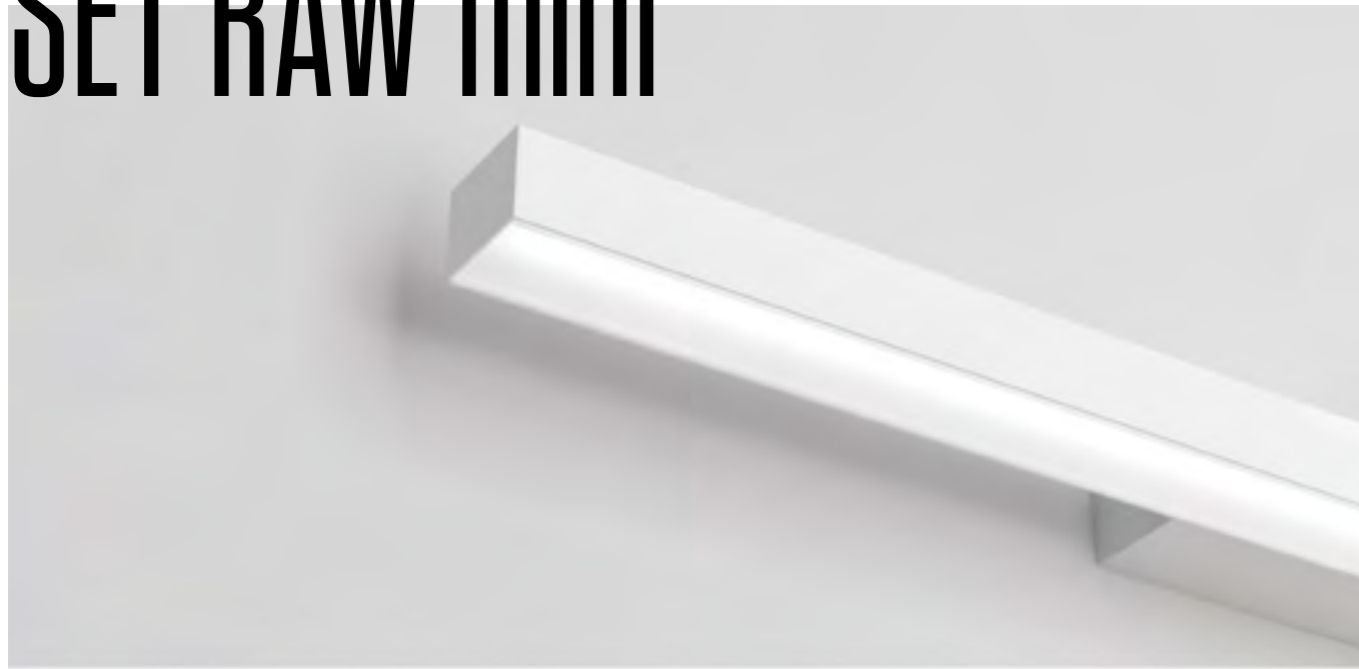

new

Don't let the shapely SET RAW mini line fool you. This slim frame is full of power. SET RAW mini, despite the delicate dimensions, can illuminate a large space (e.g. a recessed version with a length of 87cm can handle a 1.5x3x3m landing). What's more, with the new move version of this wall lamp, it is possible to direct the light in the selected direction. Such linear lighting full of grace works great as an effective highlighting of the entrance, leisure or communication zones.

Zgrabna linia SET RAW mini nie powinna uśpić naszej czujności. Ta smukła oprawa jest pełna mocy. SET RAW mini, pomimo filigranowych wymiarów, potrafi oświetlić sporą przestrzeń (np. ze spoczynkiem o wymiarach 1.5x3x3m poradzi sobie nawet wersja wpuszczana o długości 87cm). Co więcej z nową wersją kinkietu move możliwe jest skierowanie światła w wybraną stronę. Takie liniowe oświetlenie pełne gracji świetnie sprawdza się jako efektowne podkreślenie stref wejściowych, wypoczynkowych czy komunikacyjnych.



luminaire family

-  [p.086](#)
-  [p.156](#)
-  [p.214](#)
-  [p.376](#)
-  [p.414](#)

standard type

new

SET RAW mini move LED wall

aqform.com/SR2012

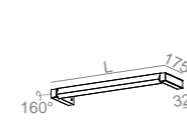

CRI>90 | 3000K | non dim

length	power	flux	cat. no
670mm	9.0W	1210lm	26501-L930-D9-00-__
970mm	13.0W	1820lm	26502-L930-D9-00-__

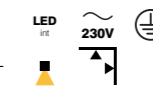

AQsmart

SET RAW mini LED wall

aqform.com/SR1012



CRI>90 | 3000K | non dim

length	power	flux	cat. no
580mm	9.0W	1210lm	26428-L930-D9-00-__
720mm	11.0W	1520lm	20212-L930-D9-00-__
870mm	13.0W	1820lm	26430-L930-D9-00-__
1010mm	15.5W	2120lm	20213-L930-D9-00-__
1150mm	17.5W	2430lm	26432-L930-D9-00-__

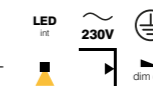

AQsmart

SET RAW mini LED hermetic wall

aqform.com/SR1812

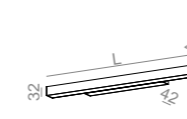

CRI>90 | 3000K | non dim

length	power	flux	cat. no
580mm	9.0W	1210lm	26346-L930-D9-00-__
720mm	11.0W	1520lm	20214-L930-D9-00-__
870mm	13.0W	1820lm	26348-L930-D9-00-__
1010mm	15.5W	2120lm	20215-L930-D9-00-__
1150mm	17.5W	2430lm	26350-L930-D9-00-__

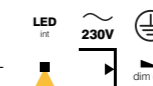

IP44
QS white

finishes

standard matt structure

QS from 01.2021



additional



additional gloss

for

SET RAW mini LED wall

SET RAW mini LED hermetic wall



all versions

Configure your product using the fold-out or our website.

LED integrated

power:

- SET RAW mini LED wall ¹ —
- 580mm — 9.0W | 17.5W
- 720mm — 11.0W | 22.0W
- 870mm — 13.0W | 26.0W
- 1010mm — 15.5W | 30.5W
- 1150mm — 17.5W | 35.0W
- 1430mm — 22.0W | 43.5W
- 1710mm — 26.5W | 52.0W
- 1990mm — 31.0W | 61.0W

CRI: CRI>90

CCT: 2700K | 3000K | 4000K

dimming optional:

DALI | switchDIM | AQsmart —

SET RAW mini LED wall from length 870mm

SET RAW mini LED hermetic wall from length 870mm

¹ same lengths and power variants are also available for SET RAW mini LED hermetic wall



private apartment, Lublin | design: Piękne Wnętrza Agata Smolińska



MAXI POINT

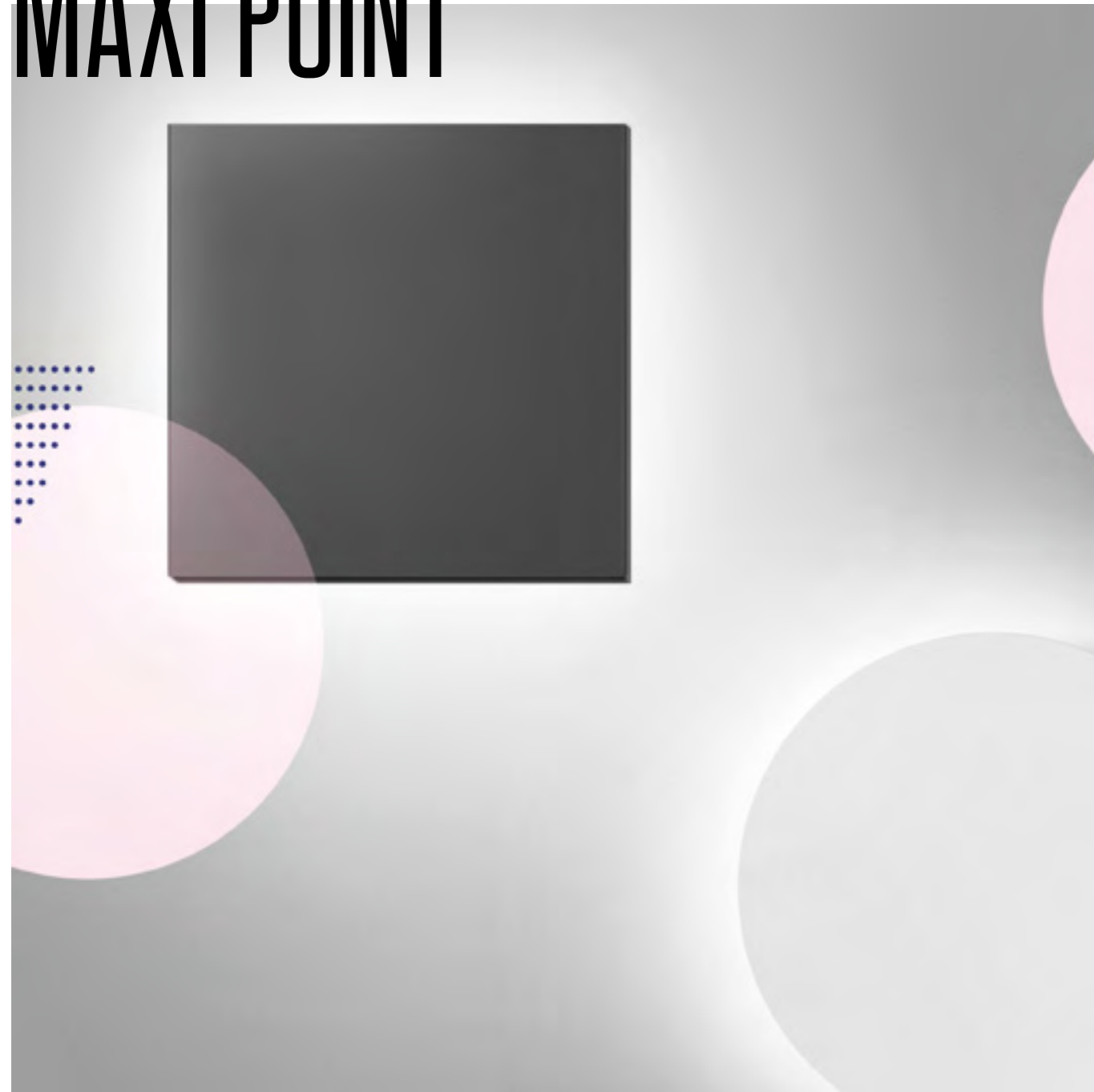

Circle or square? Softly illuminated MAXI POINT open a wide field to exercise your imagination. You can arrange them in compositions, linearly or use as individual accents. MAXI POINT light smoothly spreads sideways, so it can be used as an aesthetic background that complements the general lighting or as a subtle light signpost in communication spaces.

Kółko czy kwadrat? Miętko rozświetlone punkty MAXI POINT otwierają szerokie pole do popisu wyobraźni. Można ułożyć je w kompozycje, rozmieścić liniowo lub zastosować jako pojedyncze akcenty. Światło MAXI POINT płynnie rozchodzi się na boki, dlatego może posłużyć jako estetyczne tło, które uzupełnia oświetlenie ogólne lub jako subtelny świetlny drogowskaz w przestrzeniach komunikacyjnych.



luminaire family

[p.392](#)

standard type

MAXI POINT round LED 230V wall

aqform.com/MP0172

CRI>90 3000K Phase-Control		LED int. 230V		230V	dim
power	flux	cat. no			
4.0W	310lm	20087-L930-D9-PH-__			
6.0W	500lm	20087-M930-D9-PH-__			

MAXI POINT round LED 230V G/K wall

aqform.com/MP6172

CRI>90 3000K Phase-Control		LED int. 230V		230V	dim
power	flux	cat. no			
4.0W	310lm	20092-L930-D9-PH-__			
6.0W	500lm	20092-M930-D9-PH-__			

⌀52mm Hmin: 55mm

MAXI POINT square LED 230V wall

aqform.com/MP0272

CRI>90 3000K Phase-Control		LED int. 230V		230V	dim
power	flux	cat. no			
4.0W	310lm	20088-L930-D9-PH-__			
6.0W	500lm	20088-M930-D9-PH-__			

MAXI POINT square LED 230V G/K wall

aqform.com/MP6272

CRI>90 3000K Phase-Control		LED int. 230V		230V	dim
power	flux	cat. no			
4.0W	310lm	20093-L930-D9-PH-__			
6.0W	500lm	20093-M930-D9-PH-__			

⌀52mm Hmin: 55mm

MAXI POINT round LED 230V spider wall

aqform.com/M10172

In spider version lamp canopies are available for up to three, five or eight modules.		More info: aqform.com and at page 392.			
---	--	--	--	--	--

MAXI POINT square LED 230V spider wall

aqform.com/M10272

In spider version lamp canopies are available for up to three, five or eight modules.		More info: aqform.com and at page 392.			
---	--	--	--	--	--

finishes

standard matt structure



additional



additional gloss



all versions

Configure your product using the fold-out or our website.

LED integrated

power: 4.0W | 6.0W
CRI: CRI>90
CCT: 2700K | 3000K | 4000K
dimming standard: Phase-Control

LEDPOINT



Glowing objects attract our attention like a magnet – it is worth knowing for example, when indicating the direction with light. That is why wall lamps work well as an emphasis of communication zones in a building. LEDPOINT wall luminaires are great for this function, as they can be easily arranged into larger compositions, arranged along the corridor or staircase. They will facilitate movement, and thanks to their compact size they will not reduce the space optically.

Świejące obiekty przyciągają naszą uwagę jak magnes – warto to wykorzystać na przykład wskazując światłem kierunek. Dlatego kinkiety dobrze sprawdzają się jako podkreślenie stref komunikacyjnych w budynku. Do tej funkcji świetnie nadają się oprawy ścienne LEDPOINT, które łatwo można ułożyć w większe kompozycje, rozmieścić wzdłuż korytarza lub klatki schodowej. Ułatwią poruszanie się, a dzięki swoim kompaktowym rozmiarom nie zmniejszą optycznie przestrzeni.



standard type

LEDPOINT round 230V wall

aqform.com/LP0112

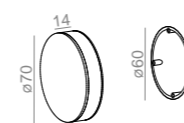

CRI>90 | 3000K | Phase-Control

power	flux	cat. no
4.0W	310lm	36710-M930-D9-PH-__

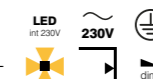

LEDPOINT round 230V G/K wall

aqform.com/LP6112

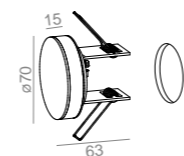

CRI>90 | 3000K | Phase-Control

power	flux	cat. no
4.0W	310lm	36712-M930-D9-PH-__

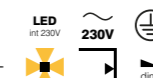

ø52mm Hmin: 55mm

LEDPOINT square 230V wall

aqform.com/LP0212

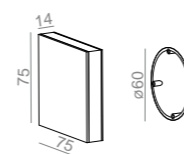

CRI>90 | 3000K | Phase-Control

power	flux	cat. no
4.0W	310lm	36706-M930-D9-PH-__

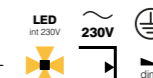

QS black

LEDPOINT square 230V G/K wall

aqform.com/LP6212

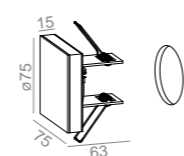

CRI>90 | 3000K | Phase-Control

power	flux	cat. no
4.0W	310lm	36708-M930-D9-PH-__

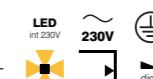

ø52mm Hmin: 55mm

finishes

standard matt structure

QS from 01.2021



additional

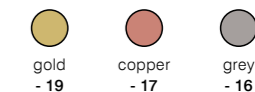

additional gloss

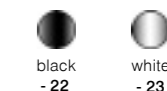

all versions

Configure your product using the fold-out or our website.

LED integrated

power: 4.0W

CRI: CRI>90

CCT: 2700K | 3000K | 4000K

dimming standard: Phase-Control



POCKET



The POCKET light is directed straight towards the floor. That's why POCKET can successfully act as the 'evening guide'. Flushed with the wall, it does not take up the space of the passageway, but instead it brightens the floor of the corridor or the surface of the stairs. Thanks to the illumination of the tread, it is easier to navigate the staircase, and the visual effect is much better.

Światło POCKET skierowane jest prosto w kierunku podłogi. Dlatego właśnie POCKET może z powodzeniem pełnić rolę „wieczornego przewodnika”. Zlicowany ze ścianą nie zajmuje przestrzeni ciągu komunikacyjnego, za to dobrze rozświetla podłogę korytarza czy powierzchnię stopni schodów. Dzięki podświetleniu stopnicy łatwiej poruszać się po klatce schodowej, o lepszym efekcie wizualnym nie wspominając.



function

standard type

POCKET mini LED wall

aqform.com/PC1012

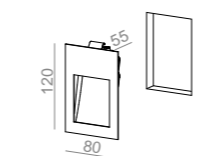

68x112mm Hmin: 60mm

CRI>90 | 3000K | non dim

power	flux
3.5W	340lm

cat. no

20145-M930-D0-00-__



accessories

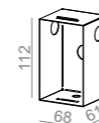

box

cat. no

mounting box for POCKET

81023-11

The mounting box is only necessary for mounting in concrete.
Puszka montażowa jest niezbędna tylko do montażu w betonie.

finishes

standard matt structure



additional

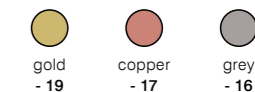

additional natural aluminium

for mounting box



all versions

Configure your product using the fold-out or our website.

LED integrated

power: 3.5W

CRI: CRI>90

CCT: 3000K | 4000K

dimming optional: Phase-Control

QUPET mini





A small wall lamp is a simple way to add variety to your interior. The vertical QUPET mini line works well in places where we want to emphasize the vertical design disposition. Due to its small size, the QUPET mini works well in smaller rooms as a single luminaire. By combining several fixtures in the composition, you can get a light effect that will also be impressive in a larger interiors.

Mały kinkiet to prosty sposób na urozmaicenie wnętrza. Wertykalna linia QUPET mini dobrze sprawdza się w miejscach, w których zależy nam na podkreśleniu pionowej dyspozycji projektu. Ze względu na niewielkie gabaryty QUPET mini jako pojedyncza oprawa dobrze radzi sobie w mniejszych pomieszczeniach. Przy połączeniu kilku opraw w kompozycji można uzyskać efekt świetlny, który będzie imponujący również w większym wnętrzu.

function



luminaire family

-  [p.130](#)
-  [p.196](#)
-  [p.246](#)

standard type

QUPET mini LED wall

aqform.com/QU1012



CRI>90 | 3000K | 36° | non dim

power	flux
3.0W	380lm

cat. no
20082-M930-F1-00-__

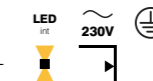

finishes

standard matt structure

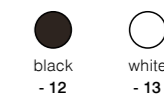

additional

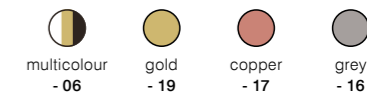

additional gloss

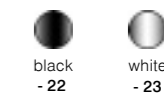

all versions

Configure your product using the fold-out or our website.

LED integrated

power: 3.0W

CRI: CRI>90

CCT: 2700K | 3000K | 4000K

beam angle: 20° | 36°

MINI CUBE / MAXI CUBE



Up and down light emitted by a shapely cube is a classic with an undeniable charm. After all, cubes are a 'little black dress' of design, that always works and never goes out of style. MINI CUBE and MAXI CUBE with a cubic shape offer universal functionality in a timeless form. Both designs look particularly good in groups because of the lighting effect they create together. Using these luminaires is the easiest way to have a night light scene in a residential interior or in a restaurant. Moreover, individual 'cubes' work well as a light accent.

Światło góra-dół emitowane przez zgrabną kostkę to klasyka, której trudno odmówić uroku. W końcu kubiki to „mała czarna” projektowania, która zawsze się sprawdza i nigdy nie wychodzi z mody. MINI CUBE i MAXI CUBE o sześciennym bryle proponują uniwersalną funkcjonalność w ponadczasowej formie. Oba wzory szczególnie dobrze prezentują się w grupach ze względu na efekt oświetleniowy jaki wspólnie tworzą. To z takich opraw najłatwiej utworzyć nocną scenę świetlną we wnętrzu mieszkalnym lub w restauracji. Z kolei pojedyncze „kostki” dobrze spisują się w roli akcentu świetlnego.



luminaire family

[p.368](#)

standard type

MINI CUBE LED 230V wall

aqform.com/MC1012

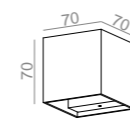

CRI>90 | 3000K | Phase-Control

power	flux	cat. no
4.0W	310lm	25671-M930-Y6-PH-__

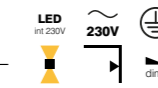

QS Q3 2020 black

QS Q3 2020 white

MINI CUBE LED 230V G/K wall

aqform.com/MC6012

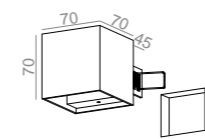

CRI>90 | 3000K | Phase-Control

power	flux	cat. no
4.0W	310lm	25673-M930-Y6-PH-__

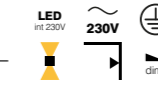

50x45mm Hmin: 70mm

accessories



cover	cat. no
cover 0	20178-__
cover 1	20179-__
cover 2	20180-__

MAXI CUBE LED 230V wall

aqform.com/MC0012

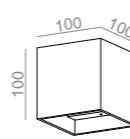

CRI>90 | 3000K | Phase-Control

power	flux	cat. no
4.0W	310lm	26336-L930-Y6-PH-__
8.0W	620lm	26336-M930-Y6-PH-__

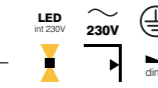

MAXI CUBE wall

aqform.com/22411

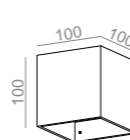

H-PIN, 230V | G9 | Phase-Control

power	cat. no
max: 48.0W	22411-0000-U8-PH-__



accessories



cover	cat. no
cover 0	22490-__
cover 1	22492-__
cover 2	22493-__

finishes

standard matt structure



additional



additional gloss



all versions

Configure your product using the fold-out or our website.

LED integrated

power: dependent on version
CRI: CRI>90
CCT: 2700K | 3000K | 4000K
dimming standard: Phase-Control

H-PIN, 230V

power: max: 48.0W
dimming standard: Phase-Control
light source not included

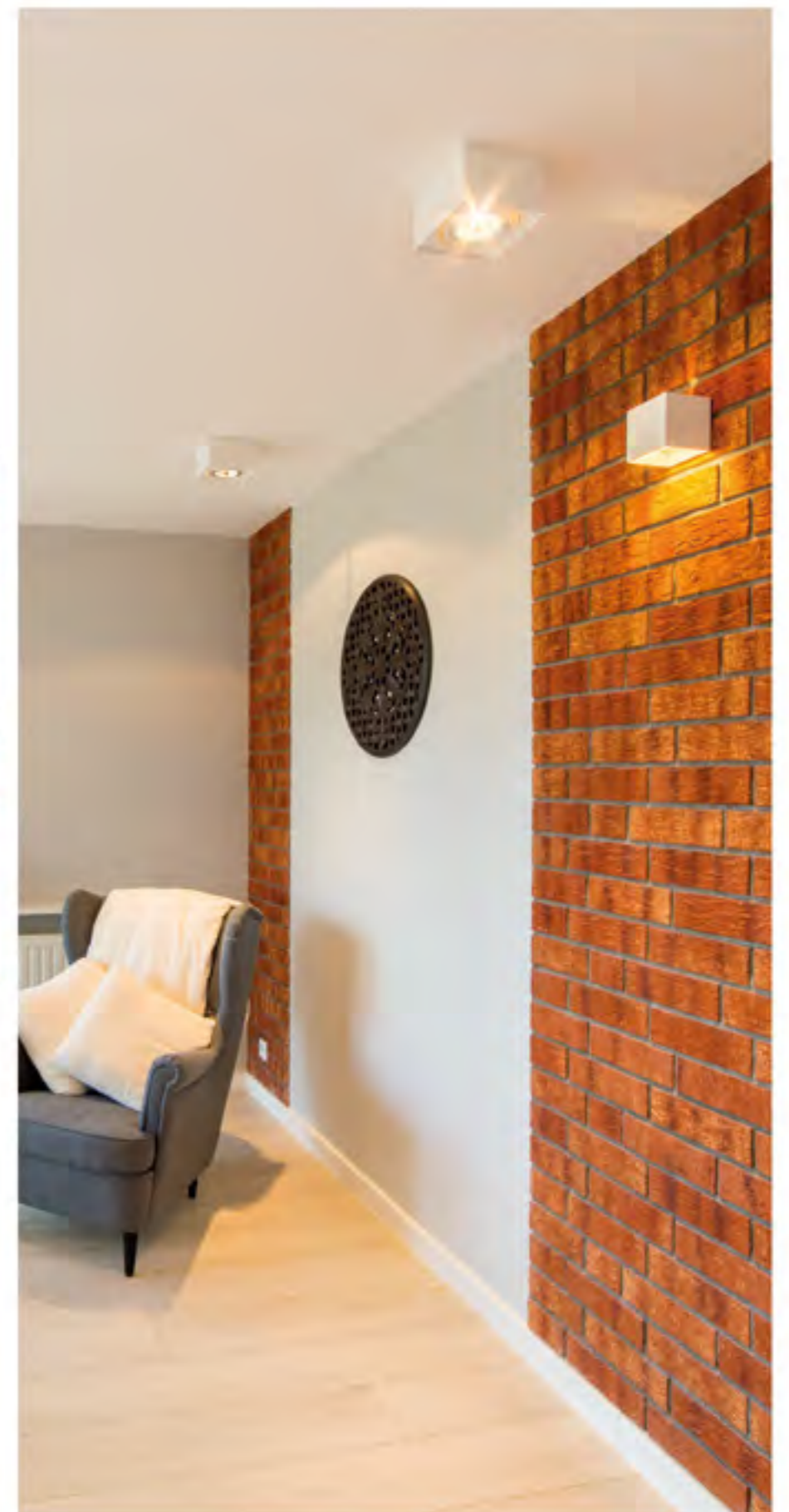
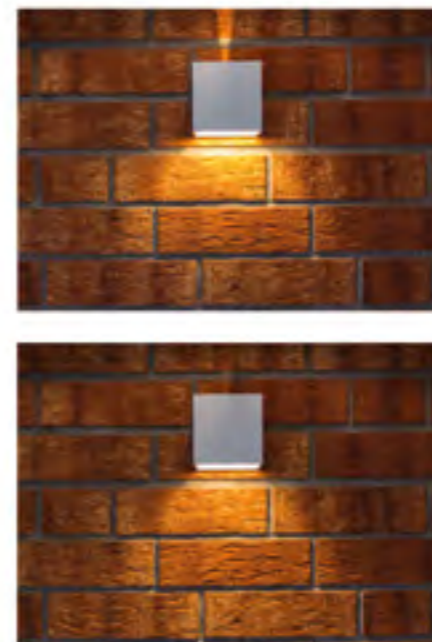
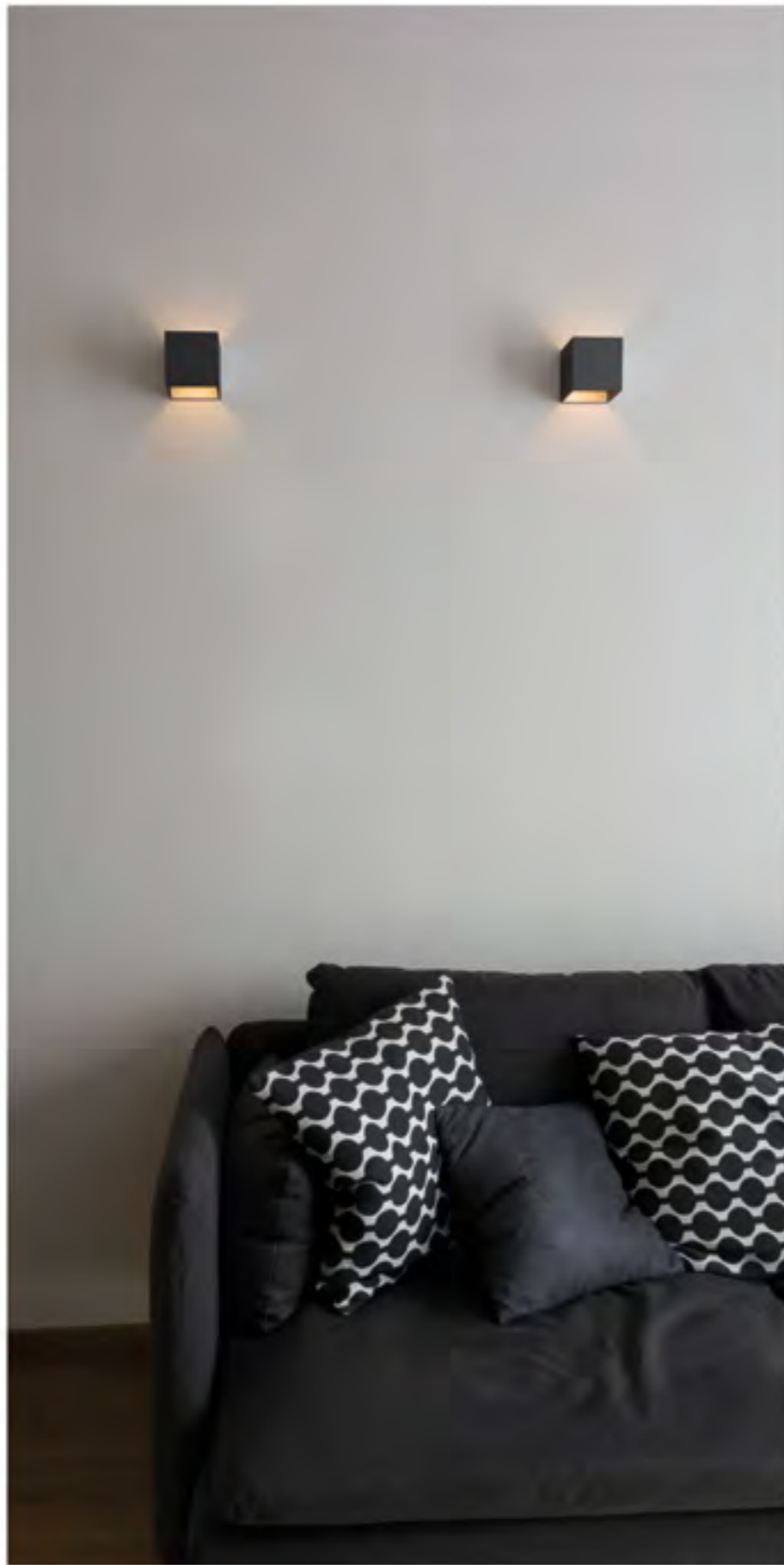

TUBA





private apartment, Lublin | design: Piękne Wnętrza Agata Smolińska

TUBA with a balanced, cylindrical shape enjoys unquestionable popularity. At the same time it is both comfortable and elegant. The light of this wall lamp flows over the wall and gently illuminates the room. It allows you to easily reach for a snack while watching a movie or during an afternoon coffee, while enjoying the cozy atmosphere. The round shape of the TUBA wall lamp fits well with various arrangements, and with a carefully selected finish it can become the leading accent of the design.

TUBA o wyważonym, walcowatym kształcie cieszy się niekwestionowaną popularnością. Równocześnie wygodna i elegancka. Światło tego kinkieta obmywa ścianę i delikatnie rozświetla pomieszczenie. Na tyle, aby podczas oglądania filmu czy popołudniowej kawy łatwo dało się sięgnąć po przekąskę, ciesząc się przy tym nastrojową atmosferą. Obły kształt kinkieta TUBA dobrze wpisuje się w różnorodne aranżacje, a przy pieczołowicie dobranym wykończeniu może stać się wiodącym akcentem projektu.



luminaire family

-  [p.122](#)
-  [p.192](#)
-  [p.258](#)

standard type

TUBA wall

aqform.com/20102

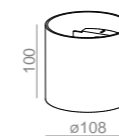

H-PIN, 230V | G9 | Phase-Control

power
max: 48.0W

cat. no

20102-0000-U8-PH-__

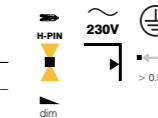

accessories



cover	cat. no
cover 0	20181-__
cover 1	20182-__
cover 2	20183-__

finishes

standard matt structure

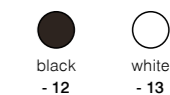

additional

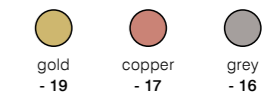

additional gloss

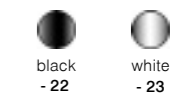

all versions

Configure your product using the fold-out or our website.

H-PIN, 230V

power: max: 48.0W

dimming standard: Phase-Control
light source not included

GRAPH



Simplicity does not mean boredom and GRAPH is a perfect example of it. Its dynamic shape is almost changing right before our eyes: balanced symmetry from the front, expressive slants from the side. Thanks to this, the very form of this wall lamp is intriguing, even when the luminaire is turned off. After turning on the light, the sharp edges fully present their potential: a beautiful light pattern is created on the wall. In a modern interior, the expressive form of GRAPH allows you to break the monotony. In more traditional spaces, it easily enters into a dialogue with decorative elements.

Prostota nie oznacza nudy i GRAPH jest tego doskonałym przykładem. Dynamiczna bryła niemal zmienia się na naszych oczach: od frontu wyważona symetria, od boku wyraziste skosy. Dzięki temu sama forma kinkietu jest intrygującym dodatkiem, nawet gdy oprawa jest wyłączona. Po zapaleniu światła, ostre krawędzie w pełni prezentują swój potencjał: na ścianie powstaje piękny świetlny wzór. W nowoczesnym wnętrzu wyrazista forma GRAPH pozwala przelać monotonię. W bardziej tradycyjnych przestrzeniach z łatwością wchodzi w dialog z elementami dekoracyjnymi.



standard type

GRAPH LED 230V wall

aqform.com/GRO012

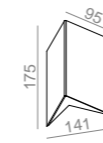

CRI>90 | 3000K | Phase-Control

power	flux	cat. no
8.0W	630lm QS	20080-M930-D9-PH-__

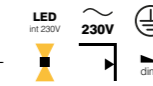

QS black
QS white

finishes

standard matt structure

QS from 01.2021



additional



additional gloss



all versions

Configure your product using the fold-out or our website.

LED integrated

power: 8.0W

CRI: CRI>90

CCT: 2700K | 3000K | 4000K

dimming standard: Phase-Control

SLEEK



SLEEK wall lamps keep a distance from the wall. Thanks to this, their light can be easily guided towards a selected direction – towards paintings or objects under the luminaire. That is why such lighting is often chosen to accent the space. SLEEK wall lamps are available in a variant for one or two points of light in the LED integrated version and for retrofit lamps.

Kinkiety SLEEK trzymają dystans od ściany. Dzięki temu ich światło można łatwo skierować w wybranym kierunku – w stronę obrazów czy obiektów znajdujących się pod oprawą. Dlatego takie oświetlenie chętnie wybierane jest do akcentowania przestrzeni. Kinkiety SLEEK dostępny jest w wariantach na jeden lub dwa punkty świetlne w wersji LED zintegrowanej oraz na wymienne źródła światła.



luminaire family

— p.072

— p.138

standard type

SLEEK 11x1 QRLED wall

aqform.com/SL3062

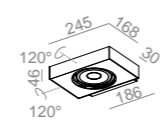

CRI>90 | 3000K | 38° | non dim

power	flux	cat. no
6.0W	880lm	20110-L930-F1-00-__
9.0W	1200lm	20110-M930-F1-00-__

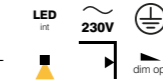

SLEEK 11x2 QRLED wall

aqform.com/SL4062

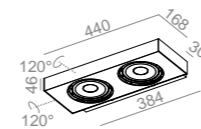

CRI>90 | 3000K | 38° | non dim

power	flux	cat. no
12.5W	1770lm	20112-L930-F1-00-__
18.0W	2410lm	20112-M930-F1-00-__

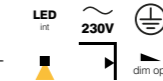

SLEEK 11x1 wall

aqform.com/26313

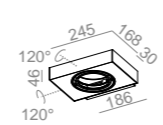

AR111, 12V AC | G53 | Phase-Control

power	cat. no
max: 50.0W, LED 12.5W	26313-0000-T8-PH-__

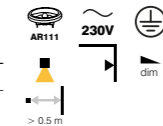

SLEEK 11x2 wall

aqform.com/26314

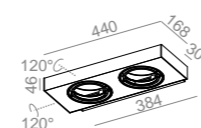

AR111, 12V AC | G53 | Phase-Control

power	cat. no
max: 2x 50.0W, LED 12.5W	26314-0000-T8-PH-__

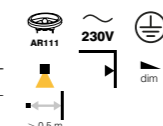

finishes

standard matt structure



additional



additional gloss



additional multicolour



all versions

Configure your product using the fold-out or our website.

LED integrated

power: dependent on version
CRI: CRI>90
CCT: 2700K | 3000K | 4000K
beam angle: 38°
dimming optional:
 Phase-Control —
 SLEEK 11x1 QRLED wall
 SLEEK 11x2 QRLED wall
 DALI | switchDIM —
 SLEEK 11x2 QRLED wall

AR111, 12V AC

power: max: 50.0W, LED 12.5W
dimming standard: Phase-Control
 light source not included

CADRA



Among those who like technical accents, CADRA enjoys unabated interest. It allows you to emphasize the texture of the wall or accent the objects under it. The double ring enables directing the lamp in a wide range. The coherent and aesthetic form facilitates the use of the fitting in many interiors.

Wśród tych, którzy lubią techniczne akcenty, CADRA cieszy się nieustającym zainteresowaniem. Pozwala podkreślić fakturę ściany lub zaakcentować przedmioty znajdujące się pod nią. Podwójny pierścień pozwala na kierowanie lampy w szerokim zakresie, a spójna i estetyczna forma ułatwia stosowanie oprawy w wielu wnętrzach.



luminaire family

[p.198](#)

standard type

CADRA 111x1 230V wall

aqform.com/24311

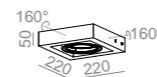

ES111, 230V | GU10 | Phase-Control

power
max: 50.0W

cat. no

24311-0000-U8-PH-__

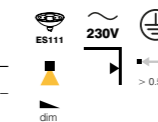

CADRA 111x2 230V wall

aqform.com/24412



ES111, 230V | GU10 | Phase-Control

power
max: 2x 50.0W

cat. no

24412-0000-U8-PH-__

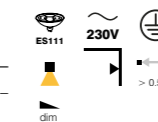

finishes

standard matt structure

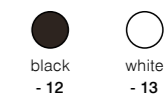

additional

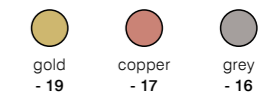

additional gloss

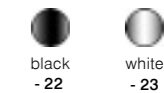

additional multicolour

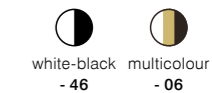

all versions

Configure your product using the fold-out or our website.

ES111, 230V

power: max: 50.0W

dimming standard: Phase-Control
light source not included

BASET

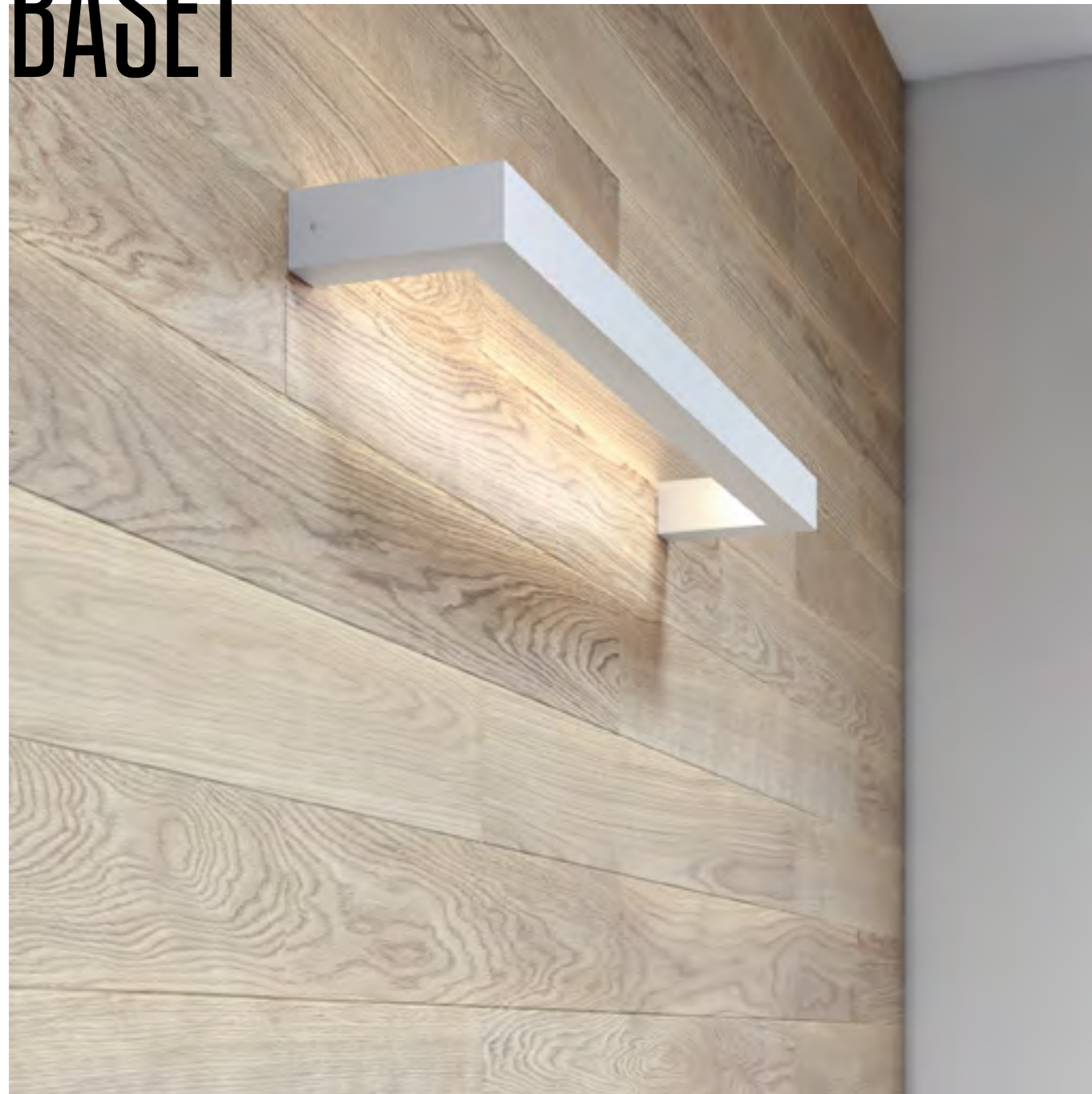

The sharp BASET line contrasts in an interesting way with its soft light. By directing the source towards the wall, the light gently reflects off its surface. This type of lighting creates good conditions for afternoon rest or conversation in the office. The illuminated wall at once becomes the background for the shape of the luminaire itself. Thanks to this, the shapely BASET line is both a comfortable light source and an aesthetic complement to the design.

Wyrazista kreska BASET w ciekawy sposób kontrastuje z jego miękkim światłem. Dzięki skierowaniu źródła w stronę ściany, światło delikatnie odbija się od jej powierzchni. Taki rodzaj oświetlenia tworzy dobre warunki do popołudniowego wypoczynku lub rozmowy w biurze. Rozświetlona ściana równocześnie staje się tłem dla samego kształtu oprawy. Dzięki temu zgrabna linia BASET jest jednocześnie komfortowym źródłem światła i estetycznym uzupełnieniem projektu.



standard type

BASET LED wall

aqform.com/BA0012

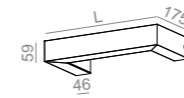

CRI>90 | 3000K | non dim

length	power	flux	cat. no
360mm	4.5W	600lm	25731-L930-D9-00-__
680mm	9.0W	1210lm	25732-L930-D9-00-__
980mm	13.0W	1820lm	25733-L930-D9-00-__

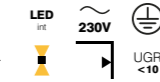

finishes

standard matt structure



additional



additional gloss

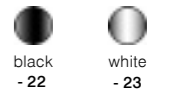

all versions

Configure your product using the fold-out or our website.

LED integrated

power:

360mm — 4.5W | 8.5W
680mm — 9.0W | 17.5W
980mm — 13.0W | 26.0W

CRI: CRI>90

CCT: 2700K | 3000K | 4000K

SMART PANEL



Linear wall lamps shining up and down are an interesting idea for breaking the flat surface. The uniform surface of the external cover is responsible for aesthetics and at the same time protects the observer's eye from glare. Thanks to this, the light spreads softly to the wall and enlivens the room in a pleasant way. This action works in any type of interior.

Liniowe kinkiety świecące w górę i w dół to ciekawy pomysł na przełamanie płaskiej powierzchni ściany. Jednolita powierzchnia zewnętrznej przesłony odpowiada za estetykę i równocześnie chroni oko obserwatora przed olśnieniem. Dzięki temu światło miękko rozchodzi się na ścianę i w miły dla oka sposób ożywia pomieszczenie. To zabieg, który sprawdza się w każdym rodzaju wnętrza.



standard type

SMART PANEL GL oval LED wall

aqform.com/SP9712

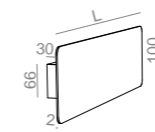

CRI>90 | 3000K | non dim

length	power	flux	cat. no
350mm	9.0W	1210lm	26328-L930-D9-00-__
640mm	17.5W	2430lm	26329-L930-D9-00-__

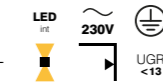

SMART PANEL GL square LED wall

aqform.com/SP9212

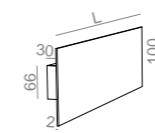

CRI>90 | 3000K | non dim

length	power	flux	cat. no
350mm	9.0W	1210lm	26330-L930-D9-00-__
640mm	17.5W	2430lm	26331-L930-D9-00-__

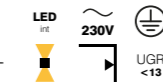

accessories

covers comparison
porównanie przesłon



finishes

standard matt structure



additional



additional gloss

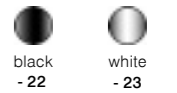

all versions

Configure your product using the fold-out or our website.

LED integrated

power:
350mm — 9.0W | 17.5W
640mm — 17.5W | 35.0W
CRI: CRI>90
CCT: 2700K | 3000K | 4000K

SET TRU



Simple, elegant and efficient. In particular in the up&down version, it works well in offices and high communication spaces. Especially that it allows the use of almost any control protocol – for example, in the AQsmart version, you can wirelessly turn on, off or dim even several lamps at the same time. A very convenient solution, especially in large spaces. In the comfort of your home, the efficiency and effectiveness of the SET TRU wall lamp will be a good solution. After all, energy saving and aesthetics are important everywhere.

Prosty, elegancki i wydajny. Zwłaszcza w wersji up&down świetnie sprawdza się w biurach i wysokich przestrzeniach komunikacyjnych. Tym bardziej, że pozwala na wykorzystanie niemal dowolnego protokołu sterowania – na przykład w wersji AQsmart bezprzewodowo można zaświecić, zgasić lub ściemnić nawet kilkanaście lamp równocześnie. Bardzo wygodne rozwiązanie, szczególnie w dużych przestrzeniach. W domowym zaciszu efektywność i efektywność kinkieta SET TRU odnajdą się równie dobrze. W końcu i oszczędność energii i estetyka są ważne w każdym miejscu.



luminaire family

-  [p.098](#)  [p.272](#)
-  [p.164](#)  [p.378](#)
-  [p.218](#)  [p.416](#)

standard type

AQsmart

SET TRU up&down LED wall

aqform.com/ST2012

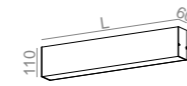

CRI>90 | 3000K | non dim

length	power	flux	cat. no
570mm	17.5W	2430lm	26458-L930-D9-00-__
860mm	26.5W	3640lm	26460-L930-D9-00-__
1140mm	35.0W	4860lm	26462-L930-D9-00-__
1420mm	44.0W	6080lm	26464-L930-D9-00-__
1700mm	53.0W	7290lm	26466-L930-D9-00-__

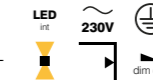

AQsmart

SET TRU LED wall

aqform.com/B00022

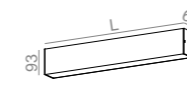

CRI>90 | 3000K | non dim

length	power	flux	cat. no
290mm	4.5W	430lm	24233-L930-D9-00-__
570mm	9.0W	1210lm	24235-L930-D9-00-__
860mm	13.0W	1820lm	24237-L930-D9-00-__
1140mm	17.5W	2430lm	24239-L930-D9-00-__
1420mm	22.0W	3040lm	24241-L930-D9-00-__

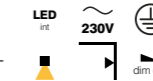

finishes

standard matt structure



additional



additional gloss



all versions

Configure your product using the fold-out or our website.

LED integrated

power:

SET TRU up&down LED wall
 570mm — 17.5W | 35.0W
 860mm — 26.5W | 52.0W
 1140mm — 35.0W | 69.5W
 1420mm — 44.0W | 87.0W
 1700mm — 53.0W | 104.5W
 1980mm — 61.5W | 122.0W

SET TRU LED wall

290mm — 4.5W | 8.5W
 570mm — 9.0W | 17.5W
 860mm — 13.0W | 26.0W
 1140mm — 17.5W | 35.0W
 1420mm — 22.0W | 43.5W
 1700mm — 26.5W | 52.0W
 1980mm — 31.0W | 61.0W

CRI: CRI>90

CCT: 2700K | 3000K | 4000K | 2700-6500K¹

dimming optional:

DALI | switchDIM | AQsmart —
 for all lengths except 290mm

¹ 2700-6500K from length 1140mm



RAFTER







The RAFTER wall lamp mounting method enabled minimizing the distance between the light and the wall. Thanks to this, the surface on which it is mounted is lit directly under the luminaire. It is a very aesthetic and comfortable solution: the milky diffuser evenly spreads the light, thanks to which the surface illuminated by the RAFTER wall is softly illuminated. Such warm light flowing around the wall does not distract attention and allows the eyes to rest.

Sposób montażu kinkieta RAFTER pozwolił zminimalizować dystans pomiędzy światłem a ścianą. Dzięki temu powierzchnia, na której jest zamocowany, rozświetlana jest bezpośrednio pod oprawą. To bardzo estetyczne i komfortowe rozwiązanie: mleczny dyfuzor równomiernie rozprasza światło, dzięki czemu powierzchnia oświetlona kinkietem RAFTER miękko się rozświetla. Takie ciepłe światło opływające ścianę nie rozprasza uwagi i pozwala odpocząć oczom.



function

luminaire family

-  [p.094](#)
-  [p.268](#)
-  [p.158](#)
-  [p.422](#)
-  [p.216](#)

standard type

AQsmart RAFTER LED wall

aqform.com/RA0012



CRI>90 | 3000K | non dim

length	power	flux	cat. no
290mm	8.5W	1210lm	20225-M930-D9-00-__
570mm	17.5W	2430lm	20226-M930-D9-00-__
860mm	26.0W	3640lm	20227-M930-D9-00-__
1140mm	35.0W	4860lm	20228-M930-D9-00-__

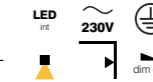

finishes

standard matt structure



additional



additional gloss



all versions

Configure your product using the fold-out or our website.

LED integrated

power:

290mm — 4.5W | 8.5W | 12.5W
 570mm — 9.0W | 17.5W | 25.0W
 860mm — 13.0W | 26.0W | 37.5W
 1140mm — 17.5W | 35.0W | 50.0W

CRI: CRI>90

CCT: 2700K | 3000K | 4000K

dimming optional:

DALI | switchDIM | AQsmart —
 from length 570mm

equilibra

Designed in collaboration with Piotr Jagiellovicz Design





The equilibra family is a design sophisticated in every inch. The collection was created in cooperation with Polish designer Piotr Jagiellovicz. Precisely selected roundings, developed proportions and refined detail create a form that is solid and soft at the same time. Thanks to this, the equilibra mounted on the wall itself becomes a work of art. It is also very functional and a mirror or wall illuminated with this luminaire become truly beautiful.

Rodzina equilibra to design dopracowany w każdym calu. Kolekcja powstała we współpracy z polskim projektantem Piotrem Jagielloviczem. Precyzyjnie dobrane zaokrąglenia, wypracowane proporcje i doszlifowany detal tworzą bryłę, która w odbiorze jest solidna i równocześnie miękka. Dzięki temu equilibra zamocowana na ścianie sama staje się swoistym dziełem sztuki. Do tego bardzo funkcjonalnym, a lustro czy ściana rozświetlone tą oprawą pięknieją w oczach.



luminaire family

 [p.146](#)

 [p.204](#)

standard type

equilibra DIRECT 17 LED 230V wall

aqform.com/EQ1012

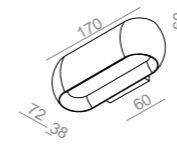

CRI>90 | 3000K | Phase-Control

power	flux	cat. no
8.0W	630lm	20053-M930-D9-PH-__

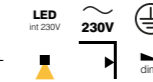

equilibra DIRECT LED wall

aqform.com/EQ0033

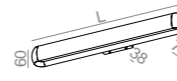

CRI>90 | 3000K | non dim

length	power	flux	cat. no
360mm	8.5W	1210lm	20054-M930-D9-00-__
640mm	17.5W	2430lm	20055-M930-D9-00-__
920mm	26.0W	3640lm	20056-M930-D9-00-__
1200mm	35.0W	4860lm	20057-M930-D9-00-__
1480mm	43.5W	6070lm	20058-M930-D9-00-__

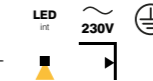

equilibra SOFT LED wall

aqform.com/EQ0023

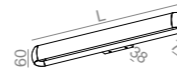

CRI>90 | 3000K | non dim

length	power	flux	cat. no
360mm	9.0W	1000lm	20040-M930-D0-00-__
640mm	18.5W	2010lm	20041-M930-D0-00-__
920mm	27.5W	3020lm	20042-M930-D0-00-__
1200mm	37.0W	4030lm	20043-M930-D0-00-__
1480mm	46.0W	5040lm	20044-M930-D0-00-__



finishes

standard matt structure



additional



additional gloss



all versions

Configure your product using the fold-out or our website.

LED integrated

power:

equilibra DIRECT LED wall
 360mm — 4.5W | 8.5W
 640mm — 9.0W | 17.5W
 920mm — 13.0W | 26.0W
 1200mm — 17.5W | 35.0W
 1480mm — 22.0W | 43.5W

equilibra SOFT LED wall

360mm — 9.0W
 640mm — 18.5W
 920mm — 27.5W
 1200mm — 37.0W
 1480mm — 46.0W

CRI: CRI>90

CCT:

2700K | 3000K | 4000K —
 equilibra DIRECT 17 LED 230V wall
 equilibra DIRECT LED wall
 3000K | 4000K —
 equilibra SOFT LED wall

LED 230V integrated

power: 8.0W

CCT: 2700K | 3000K | 4000K

dimming standard: Phase-Control



private apartment, Ruda Śląska | design: Modus Architekci, Zabrze | photo: Noysei



THIN TUBE

Designed in collaboration with Piotr Jagiellowicz Design



This neat wall lamp with a diameter of just 4cm offers great possibilities. The slim design with a round cross-section guarantees visual lightness, and LED sources – efficiency. Thanks to this one wall lamp you can illuminate a mirror with a width of up to 150cm. THIN TUBE luminaires are available in gloss finish, which harmonizes well with ceramics, wood or architectural concrete. The minimalist form and linear disposition of THIN TUBE are hard to resist.

Ten zgrabny kinkiet o średnicy zaledwie 4cm oferuje nie lada możliwości. Smukła konstrukcja o okrągłym przekroju gwarantuje wizualną lekkość, a efektywne źródła LED – wydajność. Dzięki temu jednym kinkietem można oświetlić lustro o szerokości nawet 150cm. Oprawy THIN TUBE są dostępne w wykończeniu połysk, które świetnie współgra z ceramiką, drewnem czy betonem architektonicznym. Minimalistycznej formie i liniowej dyspozycji THIN TUBE trudno się oprzeć.

function



luminaire family

 [p.222](#)

 [p.382](#)

standard type

THIN TUBE LED wall

aqform.com/TT0012

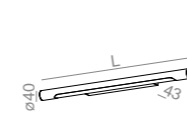

CRI>90 | 3000K | non dim

length	power	flux	cat. no
400mm	4.5W	600lm	26408-L930-D9-00-__
680mm	9.0W	1210lm	26410-L930-D9-00-__
960mm	13.0W	1820lm	26412-L930-D9-00-__
1240mm	17.5W	2430lm	26414-L930-D9-00-__
1520mm	22.0W	3040lm	26416-L930-D9-00-__

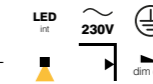

finishes

standard matt structure



additional



additional gloss



all versions

Configure your product using the fold-out or our website.

LED integrated

power:

400mm — 4.5W | 8.5W
680mm — 9.0W | 17.5W
960mm — 13.0W | 26.0W
1240mm — 17.5W | 35.0W
1520mm — 22.0W | 43.5W

CRI: CRI>90

CCT: 2700K | 3000K | 4000K







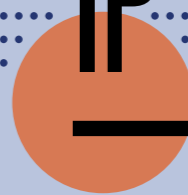
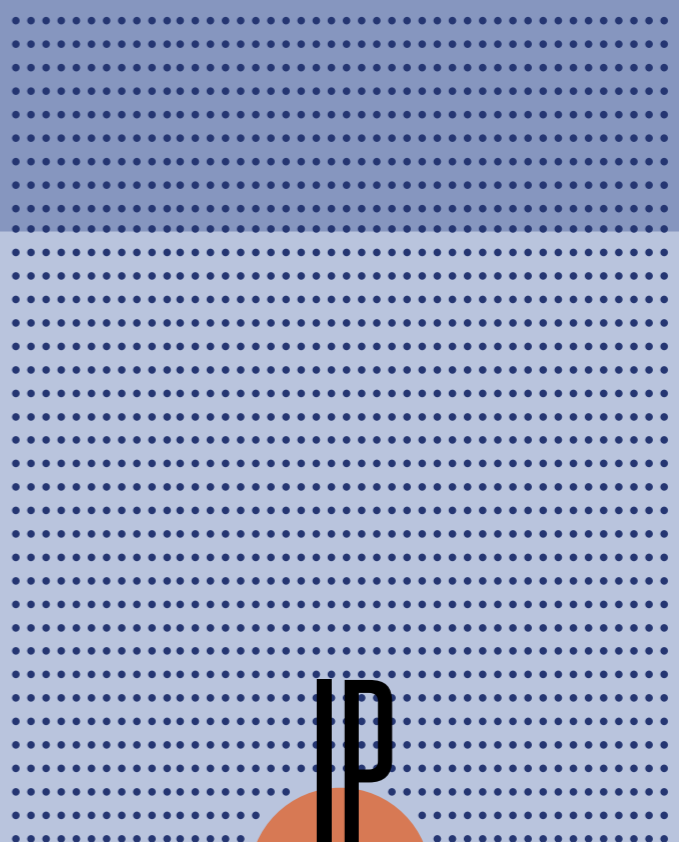



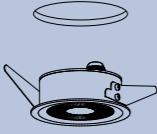
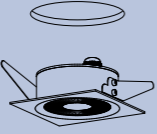

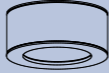
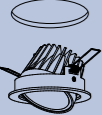

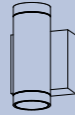
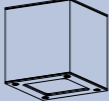
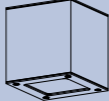
dimming:

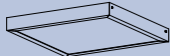
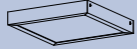
DALI | switchDIM —
from length 680mm



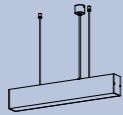

IP RATED

GOLD wall p. 350 	MODERN GLASS Tube wall p. 352 	ONLY round mini recessed p. 356 	ONLY square mini recessed p. 356 	ONLY round mini surface p. 356 	ONLY round surface p. 356 
LED EYE recessed p. 358 	PET surface p. 362 	PEX wall p. 364 	PEX up&down wall p. 364 	MAXI CUBE surface p. 368 	MAXI CUBE wall p. 368 
BLOS 2 surface p. 370 	BLOS surface p. 370 	BLOS mini surface p. 370 	BLOS round surface p. 370 	SLIMMER surface p. 374 	SLIMMER wall p. 374 
SET RAW mini wall p. 376 	SET TRU surface p. 378 	SET TRU suspended p. 378 	SET TRU wall p. 378 	THIN TUBE wall p. 382 	

Illustrative presentation of ingress protection zones

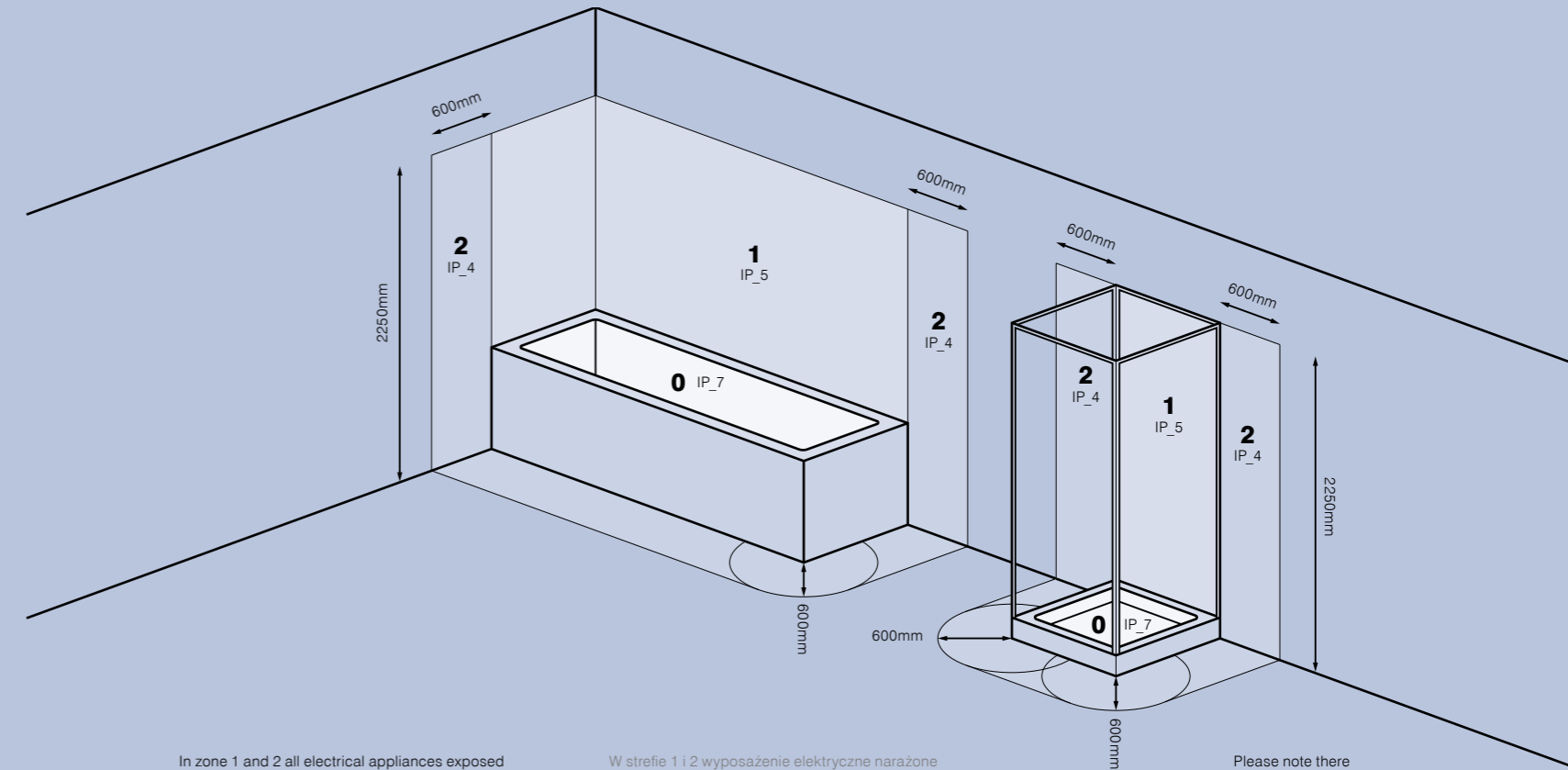

In zone 1 and 2 all electrical appliances exposed to direct water jets require minimum IPX5.

based on PN-HD 60364-7-701: 2010

Rooms containing bathtub or a shower require certain ingress protection in luminaires, which depends on localisation in all appliances. Ingress Protection Rating (IP) usually contains two digits. First one tells you how well a luminaire is protected against solids ingress. Second one is most important in case of bathrooms and tells how water-proof a luminaire is.

Please note, that normative references describe minimum requirements. Thus, it is crucial to regard both purpose and maintenance of the room. It is also important to take aggressive conditions under consideration. It could be steam condensation, constant high humidity or even overly curious kids.

W strefie 1 i 2 wyposażenie elektryczne narażone na strumienie wody ma wymóg IPX5.

na podstawie PN-HD 60364-7-701: 2010

W pomieszczeniach z wanną lub prysznicem, w zależności od lokalizacji urządzeń, wymagane jest zapewnienie odpowiedniej klasy szczelności opraw oświetleniowych. Klasa szczelności (IP) jest najczęściej opisana dwiema cyframi. Pierwsza określa stopień odporności urządzeń na przedostawanie się ciał stałych. Druga, najważniejsza w przypadku łazienek, określa stopień ochrony przed wodą.

Należy pamiętać, że normy określają minimalne wymagania, stąd ważne jest branie pod uwagę zarówno przeznaczenia pomieszczenia, jak i sposobu jego konserwacji. Trzeba również uwzględnić warunki agresywne np. możliwość skraplania się pary wodnej, utrzymującą się wysoką wilgotność, a nawet ciekawskie dzieci.

Please note there are national deviations. Examples below:

- Spain, Czech Republic: zone 2 over zone 1 extended to 300cm
- Netherlands: 225cm dimension changes to 260cm
- Ireland: there is zone 3 240cm from zone 2 horizontally and 75cm above zones 1 and 2
- France: zone 2 IPX3, there is zone 3 that extends 240cm from zone 2 horizontally

GOLO

new



Expressive up&down light is the GOLO's hallmark. It is not difficult to imagine the nice atmosphere created by GOLO nearby bathtub or a mirror. This is possible thanks to the IP44 protection rating, which allows this fixture to be used even in the II protection zone in bathrooms. The metal body with a glass lens and beautiful light create an extremely elegant trio. This combination will work in both residential and commercial interiors.

Wyraziste światło góra-dół to wizytówka GOLO. Nietrudno wyobrazić sobie klimat jaki stworzy zamocowany w pobliżu wanny czy lustra. Jest to możliwe dzięki klasie szczelności IP44, która pozwala zastosować GOLO nawet jako oświetlenie w II strefie ochrony w łazienkach. Metalowy korpus ze szklaną soczewką i pięknym światłem tworzą wyjątkowo eleganckie trio. To połączenie, które sprawdzi się zarówno we wnętrzach mieszkalnych, jak i tych o charakterze komercyjnym.



standard type

GOLO LED hermetic wall

aqform.com/GL0012

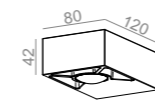

CRI>90 | 3000K | 65° | non dim

power	flux	cat. no
1.5W	180lm	26495-L930-W3-00-__
3.0W	350lm	26495-M930-W3-00-__



QS black
QS white

finishes

standard matt structure

QS from 01.2021

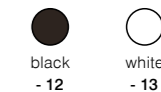

additional

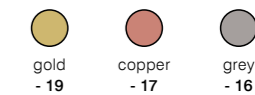

all versions

Configure your product using the fold-out or our website.

LED integrated

power: dependent on version

CRI: CRI>90

CCT: 2700 | 3000K | 4000K

beam angle: 65°

MODERN GLASS

new



It is worth taking care of the aesthetic accessories in the interior, because details build the atmosphere. Especially if they emit light. Glass fixtures work very well in this role. The MODERN GLASS wall gives you the option of choosing a glass finish: matt, transparent, smoked or with a rhombus texture. The milky-matt lampshade additionally protects against glare, which translates into higher visual comfort. Mounted in the bathroom on both sides of the mirror will correctly light up the face, aligning the shadows. Other, more transparent variants of glass will brighten the wall more strongly, creating a decorative effect.

Warto zadbać o estetyczne dodatki we wnętrzu, w końcu to detale budują atmosferę. Szczególnie, jeśli emitują światło. W tej roli świetnie sprawdzają się szklane oprawy. Kinkiet MODERN GLASS daje możliwość wyboru wykończenia szkła: matowe, transparentne, dymione lub z fakturą romb. Matowo-mleczny klosz dodatkowo chroni przed olśnieniem, co przekłada się na wyższy komfort wizualny. Zamontowany w łazience, po dwóch stronach lustra, poprawnie oświetli twarz, wyrównując cienie. Pozostałe, bardziej transparentne warianty szkła, mocniej rozświetlą ścianę, tworząc dekoracyjny efekt.



luminaire family

-  [p.110](#)
-  [p.176](#)
-  [p.292](#)
-  [p.392](#)

standard type

MODERN GLASS Tube TP LED 230V hermetic wall

aqform.com/MG3812

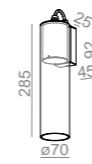

CRI>90 | 3000K | Phase-Control

power	flux	cat. no
6.0W	500lm	26498-M930-D9-PH-__

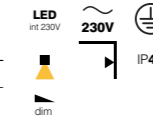

MODERN GLASS Tube SP LED 230V hermetic wall

aqform.com/MG3812

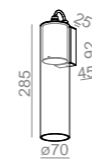

CRI>90 | 3000K | Phase-Control

power	flux	cat. no
6.0W	500lm	26499-M930-D9-PH-__

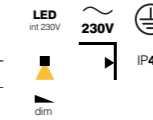

MODERN GLASS Tube TR LED 230V hermetic wall

aqform.com/MG3812

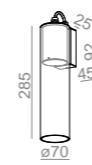

CRI>90 | 3000K | Phase-Control

power	flux	cat. no
6.0W	500lm	26497-M930-D9-PH-__

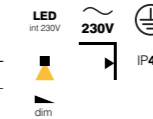

MODERN GLASS Tube WP LED 230V hermetic wall

aqform.com/MG3812

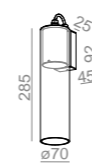

CRI>90 | 3000K | Phase-Control

power	flux	cat. no
6.0W	500lm	26500-M930-D9-PH-__

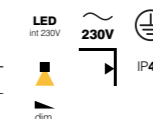

glass finishes Tube



TP

SP

TR

WP

new

finishes

standard matt structure



additional



all versions

Configure your product using the fold-out or our website.

LED 230V integrated

power: 6.0W
CRI: CRI>90
CCT: 2700 | 3000K | 4000K
dimming standard: Phase-Control



ONLY



Small dimensions with high ingress protection rating is a big advantage of the ONLY mini hermetic family. Thanks to IP65 it can be used even above an open shower cabin, over a bathtub and outside the house. The surface-mounted variant is available in two lengths (6cm, 10cm), and the recessed version is dedicated to bathrooms with a suspended ceiling. The luminaire optics is optimized for use in small spaces. Thanks to this, lighting design even in small toilets or shower cabins using the ONLY family is extremely easy.

Niewielkie gabaryty przy wysokiej klasie szczelności to duża zaleta rodziny ONLY mini hermetic. Dzięki IP65 można ją stosować nawet nad otwartą kabiną prysznicową, nad wanną oraz na zewnątrz domu. Wariant natynkowy jest dostępny w dwóch długościach (6cm, 10cm), a do łazienek z sufitem podwieszanym dedykowana jest wersja wpuszczana. Optyka oprawy jest zoptymalizowana do stosowania w niewielkich pomieszczeniach. Dzięki temu dobór oświetlenia nawet w małych toaletach czy kabinach prysznicowych przy wykorzystaniu rodziny ONLY jest niezwykle łatwy.



luminaire family

[p.116](#)

standard type

NEW

ONLY round mini LED 230V hermetic recessed

aqform.com/ON1873

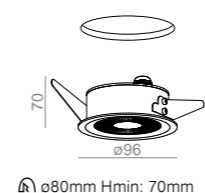

CRI>90 | 3000K | 32° | Phase-Control

power	flux	cat. no
8.0W	620lm	37951-M930-F3-PH-__

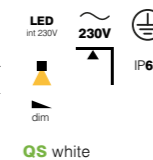

ø80mm Hmin: 70mm

NEW

ONLY square mini LED 230V hermetic recessed

aqform.com/ON2873



CRI>90 | 3000K | 32° | Phase-Control

power	flux	cat. no
8.0W	620lm	37952-M930-F3-PH-__

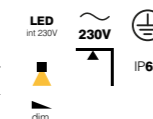

ø80mm Hmin: 70mm

ONLY round mini LED 230V hermetic surface

aqform.com/ON1874

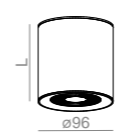

CRI>90 | 3000K | 32° | Phase-Control

length	power	flux	cat. no
60mm	6.0W	500lm	40438-M930-F3-PH-__
100mm	8.0W	620lm	40422-M930-F3-PH-__

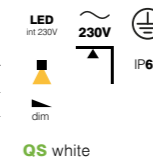

ONLY round 6 LED 230V hermetic surface

aqform.com/ON1814

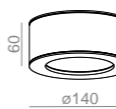

CRI>90 | 3000K | Phase-Control

power	flux	cat. no
8.0W	620lm	40017-L930-P7-PH-__
12.0W	920lm	40017-M930-P7-PH-__

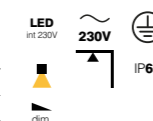

finishes

standard matt structure

QS from 01.2021



additional

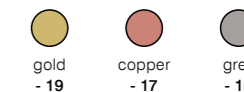

all versions

Configure your product using the fold-out or our website.

LED 230V integrated

power: dependent on version

CRI: CRI>90

CCT: 2700 | 3000K | 4000K

beam angle:

32° —

ONLY round mini LED 230V hermetic recessed

ONLY square mini LED 230V hermetic recessed

ONLY round mini LED 230V hermetic surface

dimming standard: Phase-Control

LED EYE



Bathroom requires high ingress protection from the lighting equipment, as well as good colour rendering and small size. The LED EYE family has them all. Additionally, thanks to the possibility of movement, LED EYE luminaires allow to light up every nook of the interior – just point the spotlight in the right direction. Arranged evenly, they work well as general lighting. They can also be used as a 'bathroom spotlight' – when inclined, they will accent shelves with cosmetics or a wall of an interesting texture.

Łazienka wymaga od sprzętu oświetleniowego szczelności, dobrego odwzorowania barw i niewielkich rozmiarów. Rodzina LED EYE ma je wszystkie. Dodatkowo, dzięki możliwości ruchu, oprawy LED EYE pozwalają doświetlić wszystkie zakamarki wnętrza – wystarczy skierować reflektor w odpowiednią stronę. Rozmieszczone równomiernie sprawdzą się jako oświetlenie ogólne. Można je wykorzystać też w roli „łazienkowego reflektora” – wychylone zaakcentują półki z kosmetykami lub ścianę o ciekawej fakturze.



standard type

LED EYE hermetic recessed

aqform.com/LE0803

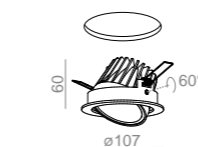

∅92mm Hmin: 70mm

CRI>90 | 3000K | 36° | non dim

power	flux	cat. no
6.0W	880lm QS	30416-L930-F1-00-__
9.0W	1200lm	30416-M930-F1-00-__

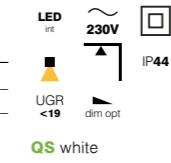

finishes

standard matt structure

QS from 01.2021



additional



additional gloss



all versions

Configure your product using the fold-out or our website.

LED integrated

power: dependent on version
 CRI: CRI>90
 CCT: 2700 | 3000K | 4000K
 beam angle: 36°
 dimming optional: DALI



PET





Simple forms are timeless. That's what PET family is. The unquestioned popularity of this collection meant that the version with increased ingress protection must have been around the corner. Style counts everywhere, also in bathrooms or on terraces. Thanks to the work of engineers, it was possible to obtain an IP65, which allows the use of the luminaire also outside the building as well as directly above the shower. We can ensure timeless minimalism in any place, regardless of its purpose.

Proste formy są ponadczasowe. Taka jest rodzina PET. Niekwestionowana popularność tej kolekcji spowodowała, że nie mogło zabraknąć wersji o podwyższonej szczelności. Styl liczy się wszędzie, również w łazienkach czy na tarasach. Dzięki pracy inżynierów udało się uzyskać stopień szczelności IP65, który pozwala na wykorzystanie oprawy również na zewnątrz budynku oraz bezpośrednio nad kabiną prysznicową. Możemy zadbać o ponadczasowy minimalizm w każdym miejscu, niezależnie od przeznaczenia przestrzeni.



function

luminaire family

-  [p.106](#)  [p.392](#)
-  [p.174](#)
-  [p.228 / 230](#)

standard type

PET LED 230V hermetic surface

aqform.com/PE0874



CRI>90 | 3000K | 27° | Phase-Control

power	flux	cat. no
8.0W	620lm	40420-M930-F3-PH-__

QS

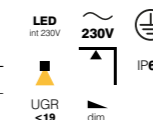

QS Q3 2020 black

QS Q3 2020 white

finishes

standard matt structure



additional



additional gloss

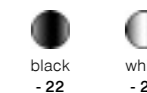

all versions

Configure your product using the fold-out or our website.

LED 230V integrated

power: 8.0W
 CRI: CRI>90
 CCT: 2700 | 3000K | 4000K
 beam angle: 27°
 dimming standard: Phase-Control

PEX



After dark, light can beautifully shape the facade of a building. Properly selected, aside from the good outlook, it can bring a significant value in use – indicate the direction or light the pathway. PEX wall offers two-way or one-way lighting. Thanks to this, you can charm out comprehensive (and beautiful) illuminations on the single-family houses facades. It is worth taking care of such evening scenery – well designed lighting solution can bring out the beauty of a building at night.

Po zmroku światło potrafi pięknie kształtować elewację budynku. Odpowiednio dobrane, obok walorów wizualnych, może nieść ze sobą istotną wartość użytkową – wskazywać kierunek czy oświetlać drogę. Kinkiety PEX oferuje świecenie dwukierunkowe lub jednokierunkowe. Dzięki temu pozwala wyczarować kompleksowe (i piękne) iluminacje na fasadach domów jednorodzinnych. Warto zadbać o taką wieczorną scenę – dobrze zaprojektowane światło potrafi wydobyć nocną porą piękno każdego budynku.



standard type

PEX LED 230V hermetic wall

aqform.com/PX0012

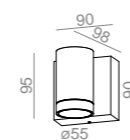

CRI>80 | 3000K | 35° | Phase-Control

power	flux	cat. no
8.0W	710lm	20141-M830-F1-PH-18

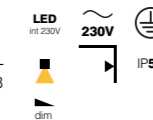

PEX up&down LED 230V hermetic wall

aqform.com/PX1012

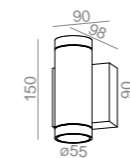

CRI>80 | 3000K | 35° | Phase-Control

power	flux	cat. no
11.5W	1160lm	20147-M830-F1-PH-18

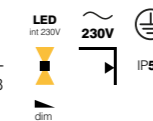

light distribution

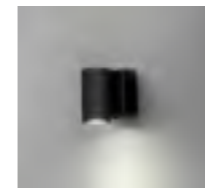

down



up&down

finishes

standard matt structure



all versions

Configure your product using the fold-out or our website.

LED 230V integrated

power: dependent on version
CRI: CRI>80
CCT: 3000K | 4000K
beam angle: 35°
dimming standard: Phase-Control

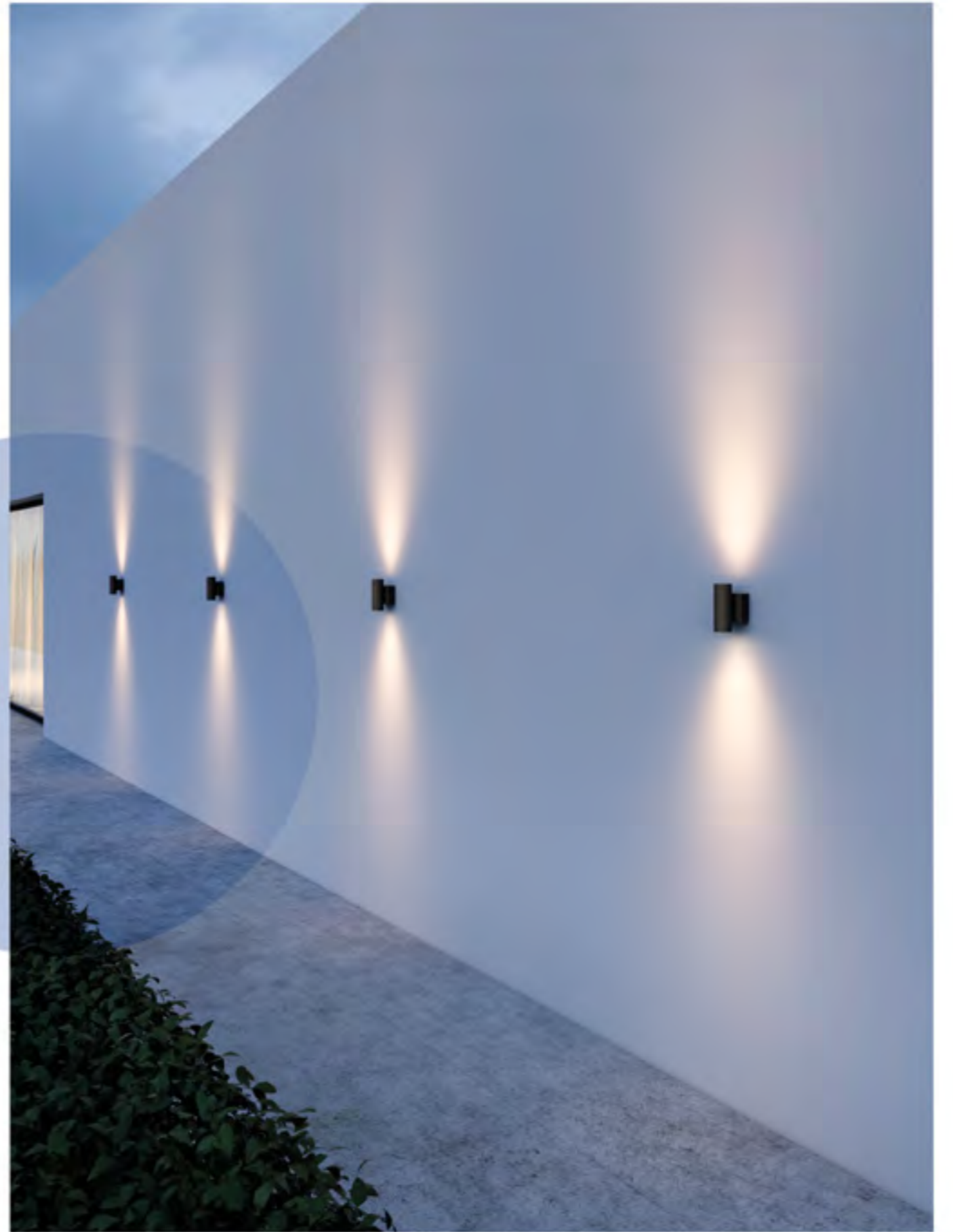

MAXI CUBE



The MAXI CUBE hermetic collection with cubic shape is particularly popular as lighting for facades, terraces and patios. The up&down light proposed by this wall luminaire, especially in rhythmic composition, perfectly emphasizes dynamic, vertical forms. A single MAXI CUBE can accent the entrance or highlight the building number. The surface-mounted version softly lights the floor below. Used together, these luminaires complement their functions by creating a comprehensive, functional and eye-catching evening light scene.

Kolekcja MAXI CUBE hermetic o kubicznej bryle cieszy się szczególnym powodzeniem jako oświetlenie elewacji, tarasów czy patio. Światło góra-dół proponowane przez kinkiet, szczególnie w rytmicznej kompozycji, znakomicie podkreśla dynamiczne, wertykalne formy. Pojedyncza oprawa może zaakcentować wejście czy oświetlić numer budynku. Wersja natynkowa miękko rozświetla drogę poniżej. Oprawy te zastosowane razem uzupełniają swoje funkcje tworząc kompleksową, funkcjonalną i miłą dla oka wieczorną scenę świetlną.



luminaire family

— | [p.316](#)

standard type

MAXI CUBE LED 230V hermetic surface

aqform.com/MC0814

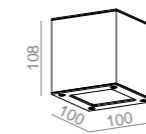

CRI>90 | 3000K | Phase-Control

power	flux	cat. no
8.0W	620lm	40514-M930-P7-PH-__

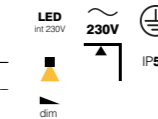

MAXI CUBE LED 230V hermetic wall

aqform.com/MC0812

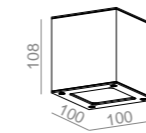

CRI>90 | 3000K | Phase-Control

power	flux	cat. no
8.0W	630lm	25661-L930-P7-PH-__
16.0W	1240lm	25661-M930-P7-PH-__

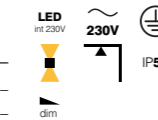

finishes

standard matt structure



additional



all versions

Configure your product using the fold-out or our website.

LED 230V integrated

power: dependent on version
CRI: CRI>90
CCT: 2700K | 3000K | 4000K
dimming standard: Phase-Control

BLOS



The BLOS collection softly lights the interior without creating thick shadows. This is possible thanks to the cover which diffuses the light emitted by the lamp. Its small height (only 6cm) makes the BLOS family also work well in lower rooms. Photometric parameters in combination with an ingress protection class of at least IP44 make BLOS luminaires ideal for general lighting for bath-rooms, including very spacious ones.

Kolekcja BLOS miękko rozświetla wnętrza nie powodując powstawania gęstych cieni. Jest to możliwe dzięki przesłonie, która rozprasza światło emitowane przez oprawę. Niewielka wysokość obudowy (zaledwie 6cm) powoduje, że rodzina BLOS sprawdza się też w niższych pomieszczeniach. Parametry fotometryczne w połączeniu z klasą szczelności co najmniej IP44 sprawiają, że oprawy BLOS świetnie nadają się jako oświetlenie ogólne łazienek, również tych bardzo przestronnych.



standard type

BLOS round 32 LED hermetic surface

aqform.com/BL1114

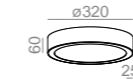

CRI>90 | 3000K | non dim

power	flux	cat. no
18.5W	2430lm	44211-L930-D9-00-__
38.0W	4870lm	44211-M930-D9-00-__



GS Q1 2021 white

AQsmart BLOS round 40 LED hermetic surface

aqform.com/BL2114

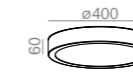

CRI>90 | 3000K | non dim

power	flux	cat. no
25.0W	3240lm	44315-L930-D9-00-__
50.0W	6490lm	44315-M930-D9-00-__



dim opt

BLOS mini LED hermetic surface

aqform.com/BL1014

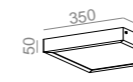

CRI>90 | 3000K | non dim

power	flux	cat. no
10.5W	1570lm	44591-L930-D9-00-__
16.0W	2180lm	44591-M930-D9-00-__



dim opt

AQsmart BLOS LED hermetic surface

aqform.com/BL0014



CRI>90 | 3000K | non dim

power	flux	cat. no
25.0W	3650lm	44611-L930-D9-00-__
42.0W	5580lm	44611-M930-D9-00-__

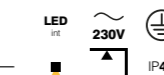

dim opt

BLOS 2 LED hermetic surface

aqform.com/BL2014

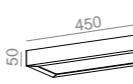

CRI>90 | 3000K | non dim

power	flux	cat. no
12.5W	1620lm	44212-L930-D9-00-__
25.0W	3240lm	44212-M930-D9-00-__

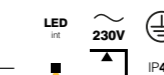

dim opt

finishes

standard matt structure



additional



additional gloss



all versions

Configure your product using the fold-out or our website.

LED integrated

power: dependent on version

CRI: CRI>90

CCT:

2700K | 3000K | 4000K —

BLOS round 32 LED hermetic surface

BLOS round 40 LED hermetic surface

BLOS LED hermetic surface

BLOS 2 LED hermetic surface

3000K | 4000K —

BLOS mini LED hermetic surface

dimming optional:

DALI | switchDIM | AQsmart —

BLOS round 40 LED hermetic surface

BLOS LED hermetic surface

DALI | switchDIM —

BLOS mini LED hermetic surface

BLOS 2 LED hermetic surface



SLIMMER



SLIMMER is a series of compact luminaires for general lighting purposes in areas exposed to humidity. In addition to the IP54 ingress protection class, they also have a low height – only 46mm. Despite their small dimensions, the surface-mounted versions will cope with general lighting, and the wall lamps will additionally allow the walls to be brightened with soft light. It is a perfect solution for people who value indirect lighting. In the case of wall lamps, mounting them upside down is also a very good idea.

SLIMMER to seria kompaktowych opraw do oświetlenia ogólnego w strefach zagrożonych wilgocią. Poza klasą szczelności IP54 charakteryzują się również niewielką wysokością – tylko 46mm. Pomimo niewielkich gabarytów, wersje natynkowe poradzą sobie z oświetleniem ogólnym, a kinkiety dodatkowo pozwolą obmyć ściany miękkim światłem. To doskonale rozwiązanie dla osób ceniących sobie oświetlenie pośrednie. W przypadku kinkietów montaż do góry nogami bywa bardzo trafnym pomysłem.

standard type

SLIMMER 17 LED hermetic surface

aqform.com/SM1814

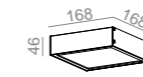

CRI>90 | 3000K | non dim

power	flux	cat. no
6.0W	810lm	40174-L930-D9-00-__
12.5W	1620lm	40174-M930-D9-00-__



SLIMMER 30 LED hermetic surface

aqform.com/SM2814

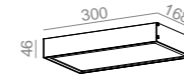

CRI>90 | 3000K | non dim

power	flux	cat. no
12.5W	1620lm	40176-L930-D9-00-__
25.0W	3240lm	40176-M930-D9-00-__



SLIMMER 17 LED hermetic wall

aqform.com/SM1812

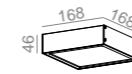

CRI>90 | 3000K | non dim

power	flux	cat. no
6.0W	810lm	20174-L930-D9-00-__
12.5W	1620lm	20174-M930-D9-00-__

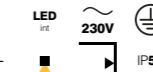

SLIMMER 30 LED hermetic wall

aqform.com/SM2812

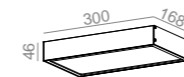

CRI>90 | 3000K | non dim

power	flux	cat. no
12.5W	1620lm	20176-L930-D9-00-__
25.0W	3240lm	20176-M930-D9-00-__



finishes

standard matt structure



additional



additional gloss



all versions

Configure your product using the fold-out or our website.

LED integrated

power: dependent on version
 CRI: CRI>90
 CCT: 2700K | 3000K | 4000K

SET RAW mini







private apartment, Lublin | design: Piękne Wnętrza Agata Smolińska

Linear wall luminaires placed over the edge of the mirror are one of the most popular solutions used in bathrooms. Fixtures mounted at the appropriate height (approx. 200cm from the floor) light up the face well and add precision to care treatments. It's no secret that it is much easier to see details in the light than in the shade. SET RAW mini easily allows one luminaire to light a mirror up to 200cm long. And all this with such filigree dimensions – the height of the luminaire is little over 3cm!

Liniowe kinkiety umieszczone nad krawędzią lustra to jedno z najpopularniejszych rozwiązań stosowanych w łazienkach. Oprawy zamocowane na odpowiedniej wysokości (ok. 200cm od podłogi) dobrze doświetlają twarz dodając precyzji zabiegom pielęgnacyjnym. Nie jest tajemnicą, że dużo łatwiej dostrzega się szczegóły w świetle niż w cieniu. SET RAW mini bez problemu pozwala jedną oprawą oświetlić lustro o długości nawet do 200cm. A wszystko to przy tak filigranowych wymiarach – wysokość oprawy to niewiele ponad 3cm!



luminaire family

-  [p.086](#)
-  [p.158](#)
-  [p.214](#)
-  [p.302](#)
-  [p.414](#)

standard type

AQsmart

SET RAW mini LED hermetic wall

aqform.com/SR1812

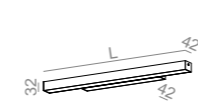

CRI>90 | 3000K | non dim

length	power	flux	cat. no
580mm	9.0W	1210lm	26346-L930-D9-00-__
720mm	11.0W	1520lm	20214-L930-D9-00-__
870mm	13.0W	1820lm	26348-L930-D9-00-__
1010mm	15.5W	2120lm	20215-L930-D9-00-__
1150mm	17.5W	2430lm	26350-L930-D9-00-__
1430mm	22.0W	3040lm	26352-L930-D9-00-__
1710mm	26.5W	3640lm	26305-L930-D9-00-__
1990mm	31.0W	4250lm	26307-L930-D9-00-__

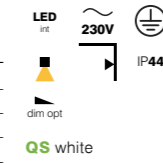

finishes

standard matt structure

QS from 01.2021



additional



additional gloss



all versions

Configure your product using the fold-out or our website.

LED integrated

power:

580mm — 9.0W | 17.5W
 720mm — 11.0W | 22.0W
 870mm — 13.0W | 26.0W
 1010mm — 15.5W | 30.5W
 1150mm — 17.5W | 35.0W
 1430mm — 22.0W | 43.5W
 1710mm — 26.5W | 52.0W
 1990mm — 31.0W | 61.0W

CRI: CRI>90

CCT: 2700K | 3000K | 4000K

dimming standard:

DALI | switchDIM | AQsmart — from length 870mm

SET TRU



The SET TRU family is a classic among lighting solutions with increased ingress protection. Several mounting options, several lengths, different powers – thanks to this, using one collection you can design lighting both in small and spacious bathrooms. SET TRU works well also as a general toilet lighting in a public facility. It all depends on how you configure the parameters of the luminaire. Extensive lighting with a minimalist form is an extremely versatile solution – comfortable and nice looking.

Rodzina SET TRU to klasyk wśród oświetlenia o podwyższonej szczelności. Kilka wariantów montażu, kilka długości, różne moce – dzięki temu z tą jedną kolekcją można zaprojektować zarówno oświetlenie niewielkiej łazienki jak i przestronnego pokoju kąpielowego. SET TRU sprawdzi się nawet jako ogólne oświetlenie toalety w obiekcie użyteczności publicznej. Wszystko zależy od tego, jak skonfigurujemy parametry oprawy. Wszechstronne oświetlenie o minimalistycznej formie to wyjątkowo udane rozwiązanie – i wygodnie, i ładnie.



luminaire family

-  [p.098](#)  [p.272](#)
-  [p.164](#)  [p.332](#)
-  [p.218](#)  [p.416](#)

standard type

AQsmart SET TRU LED hermetic surface aqform.com/ST0814

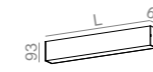

CRI>90 | 3000K | non dim

length	power	flux	cat. no
570mm	17.5W	2430lm	40082-M930-D9-00-__
860mm	26.0W	3640lm	40084-M930-D9-00-__
1140mm	35.0W	4860lm	40086-M930-D9-00-__
1420mm	43.5W	6070lm	40088-M930-D9-00-__
1700mm	52.0W	7290lm	40027-M930-D9-00-__

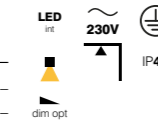

AQsmart SET TRU LED hermetic suspended aqform.com/ST0815

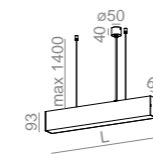

CRI>90 | 3000K | non dim

length	power	flux	cat. no
570mm	17.5W	2430lm	50192-M930-D9-00-__
860mm	26.0W	3640lm	50194-M930-D9-00-__
1140mm	35.0W	4860lm	50196-M930-D9-00-__
1420mm	43.5W	6070lm	50198-M930-D9-00-__
1700mm	52.0W	7290lm	50240-M930-D9-00-__

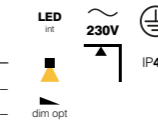

AQsmart SET TRU LED hermetic wall aqform.com/ST0812

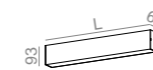

CRI>90 | 3000K | non dim

length	power	flux	cat. no
570mm	9.0W	1210lm	26363-L930-D9-00-__
860mm	13.0W	1820lm	26365-L930-D9-00-__
1140mm	17.5W	2430lm	26367-L930-D9-00-__
1420mm	22.0W	3040lm	26369-L930-D9-00-__
1700mm	26.5W	3640lm	26397-L930-D9-00-__

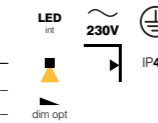

finishes

standard matt structure



additional



additional gloss



all versions

Configure your product using the fold-out or our website.

LED integrated

power:

570mm — 9.0W | 17.5W
 860mm — 13.0W | 26.0W
 1140mm — 17.5W | 35.0W
 1420mm — 22.0W | 43.5W
 1700mm — 26.5W | 52.0W

CRI: CRI>90

CCT: 2700K | 3000K | 4000K | 2700-6500K¹

dimming optional: DALI | switchDIM | AQsmart

¹ 2700-6500K from length 1140mm



THIN TUBE





The THIN TUBE collection with its aesthetic roundness is often chosen as bathroom mirror lighting solution. Finished in gloss, with raw details at both ends, it harmonizes perfectly with modern ceramics, architectural concrete and wooden finishes. The wide range of the available lengths means that one luminaire can light mirrors with a width from 40cm up to 150cm. The perfect top of a stylish bathroom – like the icing on the cake.

Kolekcja THIN TUBE ze swoją estetyczną krągłością często wybierana jest jako oświetlenie lustra w łazience. Wykończona w polysku, z surowymi detalami na obu końcach, znakomicie współgra z nowoczesną ceramiką, betonem architektonicznym czy wykończeniami drewnianymi. Szeroki wybór dostępnych długości powoduje, że jedną oprawą można oświetlić lustro o szerokości od 40cm aż do 150cm. Idealne zwieńczenie stylowej łazienki – jak wisienka na torcie.



function

luminaire family

-  [p.222](#)
-  [p.342](#)

standard type

THIN TUBE LED hermetic wall

aqform.com/TT0812

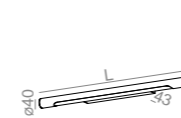

CRI>90 | 3000K | non dim

length	power	flux	cat. no
400mm	4.5W	600lm	20216-L930-D9-00-__
680mm	9.0W	1210lm	20217-L930-D9-00-__
960mm	13.0W	1820lm	20218-L930-D9-00-__
1240mm	17.5W	2430lm	20219-L930-D9-00-__
1520mm	22.0W	3040lm	20220-L930-D9-00-__

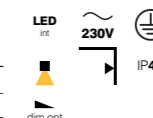

finishes

standard matt structure

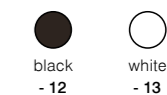

additional

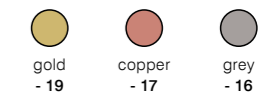

additional gloss

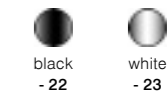

all versions

Configure your product using the fold-out or our website.

LED integrated

power:

400mm — 4.5W | 8.5W
 680mm — 9.0W | 17.5W
 960mm — 13.0W | 26.0W
 1240mm — 17.5W | 35.0W
 1520mm — 22.0W | 43.5W

CRI: CRI>90

CCT: 2700K | 3000K | 4000K

dimming optional:

DALI | switchDIM — from length 680mm

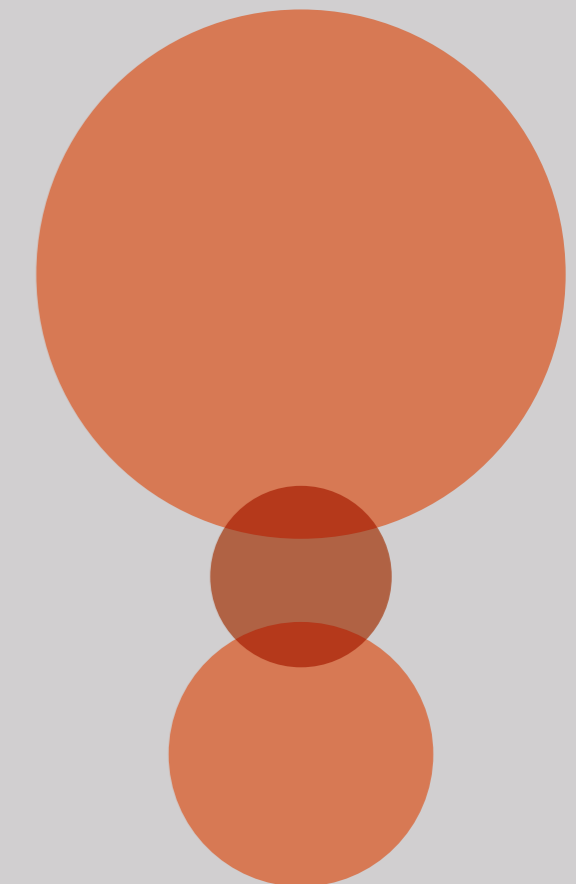

SYSTEMS

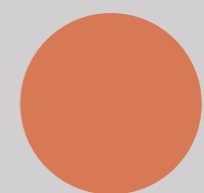

SYSTEMS

SPIDER
[p. 392](#)



RAW mini
[p. 414](#)

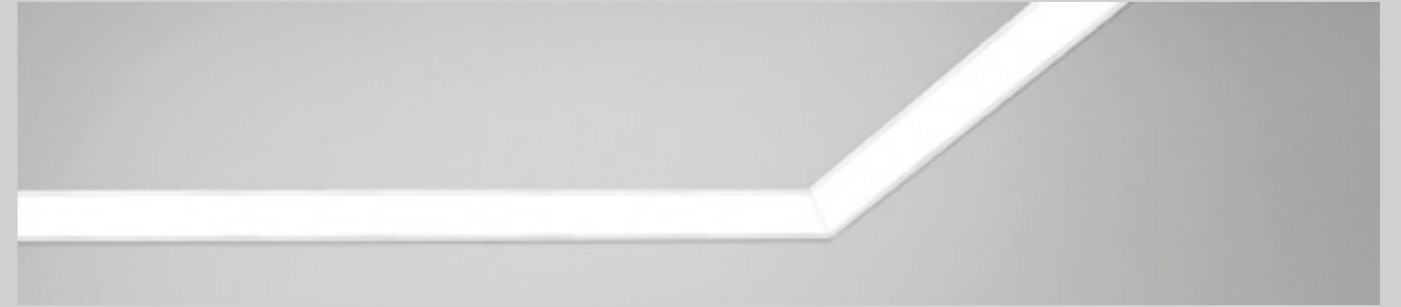

MIXLINE
[p. 402](#)



TRU
[p. 416](#)



Other solutions
needed? Check
out RAFTER (p.422)
or contact us

Custom-made solutions

Tailored lighting required?
No problem! We can do that.

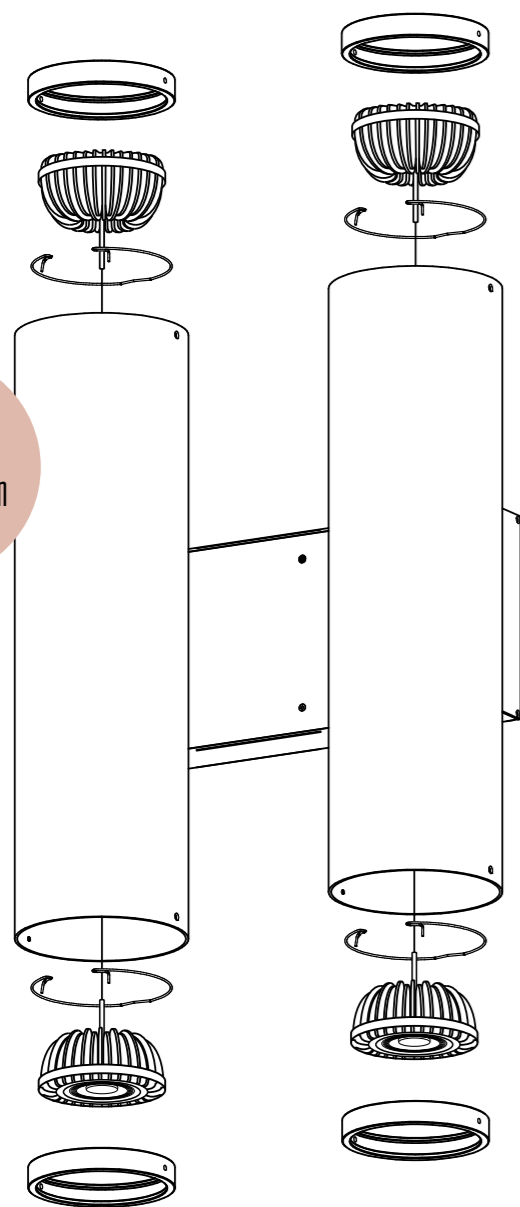

lamp

power: 4x 38W
luminous flux: 4x 4300 lm
CRI: CRI>80
CCT: 3000K

Illustration shows customized version of TUBA wall luminaire
Ilustracja pokazuje niestandardową wersję kinkieta TUBA

System luminaires are a tailored solution for specific needs. The ability to combine them into almost any lines or forms allows you to maintain a consistent style of the interior, while giving it an individual character. A 15m long corridor highlighted with one fixture along the entire length? An impressive lighting composition in the lobby connecting 14 lamps on one lamp canopy? A conference table for 20 people light up by one luminaire?

With custom-made products, everything is possible. We present most popular solutions in the system luminaires section, and if the project requires a non-standard approach – please contact us. We also realize unusual projects, due to our flexible production.

Oprawy systemowe to rozwiązanie szyte na miarę konkretnych potrzeb. Możliwość łączenia ich w niemal dowolne linie lub formy pozwala zachować spójny styl wnętrza, nadając mu zarazem indywidualny charakter. Korytarz długi na 15m podkreślony jedną oprawą wzdłuż całego biegu? Imponująca kompozycja oświetleniowa w lobby łącząca 14 lamp na jednej podsufitce? Stół konferencyjny dla 20 osób oświetlony jedną oprawą?

Z produktami tworzonymi na zamówienie to wszystko jest możliwe. Najpopularniejsze rozwiązania prezentujemy w dziale opraw systemowych, a jeśli projekt wymaga niestandardowego podejścia – zapraszamy do kontaktu. Dzięki elastycznej produkcji, realizujemy również projekty nietypowe.



One of the popular system solutions is tracks. More information about them can be found on p. 274. It is also worth knowing that most of our suspended luminaires can be adapted to be mounted on a track if needed – just like MODERN GLASS in this interior.

Jednym z popularnych rozwiązań systemowych są szynoprzewody. Więcej informacji o nich można znaleźć na str. 274. Warto też wiedzieć, że większość z naszych opraw wiszących może być, w razie potrzeby, dostosowana do montażu na szynoprzewodzie – tak, jak MODERN GLASS w tej realizacji.



If you want to effectively light an exhibition, waiting room or representative space, think about the specificity of this type of interior. System luminaires cope well with such arrangements, while ensuring the visual comfort of users, as well as maintaining high light efficiency. Such possibilities are offered for example by the combination of suspended SET TRU luminaires. More details on p. 416.

Chcąc skutecznie oświetlić ekspozycję, poczekalnię lub przestrzeń reprezentacyjną, należy pamiętać o specyfice tego typu wnętrz. Oprawy systemowe doskonale radzą sobie w takich aranżacjach, dbając jednocześnie o komfort wizualny użytkowników, a także zachowując wysoką wydajność świetlną. Takie możliwości daje np. kombinacja zwieszanych opraw SET TRU. Więcej szczegółów na str. 416.



private apartment, Kraków

The combination of several system luminaires in the recessed version will emphasize the modern character of any interior. Parallel or harmonious arrangement is possible, as well as an artistic asymmetry. MIXLINE recessed luminaires give us full freedom. Information on these types of solutions can be found on p. 402.

Zestawienie kilku opraw systemowych w wersji wpuszczanej podkreśli nowoczesny charakter każdego wnętrza. Możliwe jest równoległe, harmonijne ułożenie, ale także artystyczna asymetria. Wpuszczane oprawy MIXLINE dają nam pełną dowolność. Informacje na temat tego typu rozwiązań można znaleźć na str. 402.

system: SPIDER



The SPIDER system is a combination of many luminaires with one lamp canopy. The characteristic form guarantees full freedom – it is only up to us how we arrange the individual 'arms'. This modern accessory corresponds perfectly with various interior styles. It is a tasteful decoration in arrangements with a loft, Scandinavian or classic mood. The SPIDER system is ideally suited to the kitchen, living room, as well as public spaces. The raw charm makes it look great both in a minimalist form, e.g. with PET mini fittings, and more decorative, for example, when the MODERN GLASS series is used.

System SPIDER to połączenie wielu opraw za pomocą jednej puszkii montażowej. Charakterystyczna forma gwarantuje pełną dowolność – tylko od nas zależy w jaki sposób rozmieścimy poszczególne „ramiona”. Ten nowoczesny dodatek dobrze komponuje się z różnymi stylami wnętrz. Jest gustowną ozdobą aranżacji w klimacie loftowym, skandynawskim oraz klasycznym. System SPIDER doskonale pasuje do kuchni czy salonu, jak i do przestrzeni publicznych. Surowy wdzięk sprawia, że świetnie prezentuje się zarówno w formie minimalistycznej np. z oprawami PET mini, jak i bardziej dekoracyjnej, do której możemy wykorzystać serię MODERN GLASS.



Design your SPIDER

Take few simple steps to customize your lighting

1. Luminaire module: select the shape, finish and colour of the luminaire for the SPIDER system.

1. Moduł oprawy: wybierz kształt, wykończenie i kolor oprawy do systemu SPIDER.

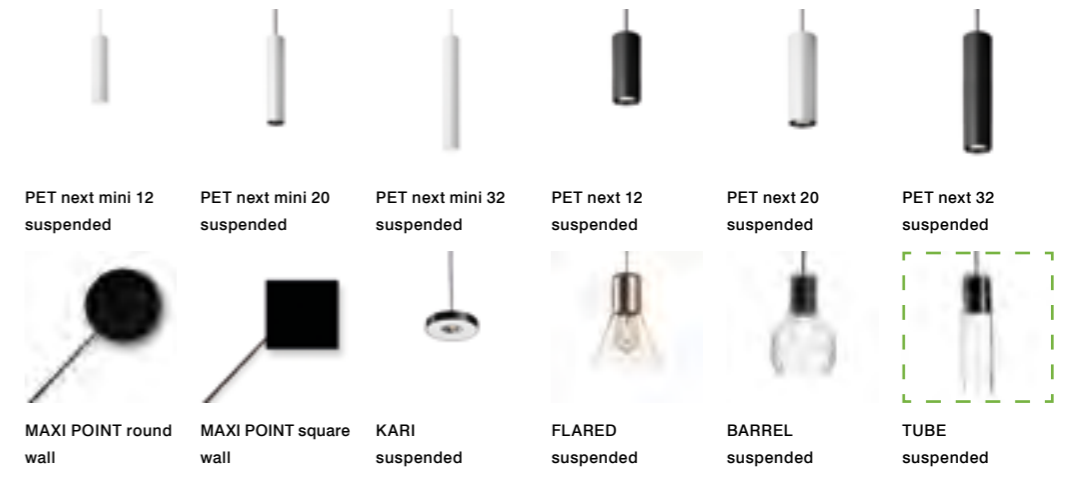

2. Lamp canopy: choose the size, colour and finish of the lamp canopy.

2. Puszka montażowa: wybierz rozmiar, kolor i wykończenie puszkii montażowej.

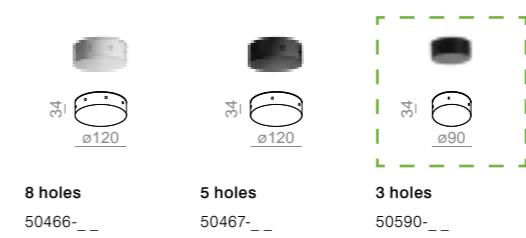

When choosing the lamp canopy please remember that more than one can be joined together. Podczas wybierania puszkii montażowej pamiętaj, że jest możliwość łączenia ze sobą wielu puszek montażowych.

3. Ceiling fixing: select the colour, finish and number of ceiling fixing needed.

3. Uchwyt montażowy: wybierz kolor, wykończenie i liczbę potrzebnych uchwytów montażowych.

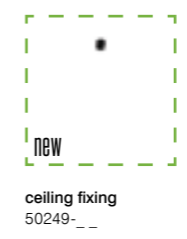

4. Cable: choose the colour of the cable, then select the amount of wires needed.

4. Przewód: wybierz kolor przewodu, a następnie wybierz liczbę potrzebnych przewodów.

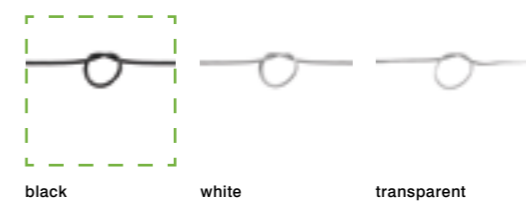

Standard cable length per SPIDER module is 1400mm. Longer on request. Standardowa długość przewodu na moduł SPIDER to 1400mm. Dłuższe dostępne na zamówienie.

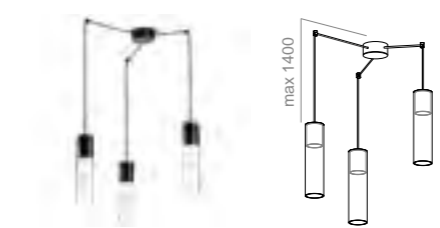

luminaire modules for spider system

new

PET next mini LED SPIDER suspended

aqform.com/P11815



PET next mini 12 LED SPIDER suspended
CRI>90 | 3000K | 4.5W | 520lm | 36° | non dim
59819-M930-F1-00-__



LED integrated

power: 4.5W
CRI: CRI>90
CCT: 2700K | 3000K | 4000K
beam angle: 20° | 36°

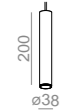

PET next mini 20 LED SPIDER suspended
CRI>90 | 3000K | 4.5W | 520lm | 36° | non dim
59820-M930-F1-00-__

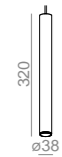

PET next mini 32 LED SPIDER suspended
CRI>90 | 3000K | 4.5W | 520lm | 36° | non dim
59821-M930-F1-00-__

new

PET next LED SPIDER suspended

aqform.com/P10815



PET next 12 LED SPIDER suspended
CRI>90 | 3000K | 8.5W | 1170lm | 35° | non dim
59816-M930-F1-00-__

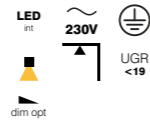

LED integrated

power: 8.5W
CRI: CRI>90
CCT: 2700K | 3000K | 4000K
beam angle: 18° | 35°
dimming optional:
DALI —
PET next 20 LED SPIDER suspended
PET next 32 LED SPIDER suspended

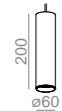

PET next 20 LED SPIDER suspended
CRI>90 | 3000K | 8.5W | 1170lm | 35° | non dim
59817-M930-F1-00-__



PET next 32 LED SPIDER suspended
CRI>90 | 3000K | 8.5W | 1170lm | 35° | non dim
59818-M930-F1-00-__

new

MAXI POINT round LED 230V spider wall

aqform.com/M10172

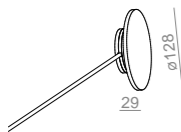

CRI>90 | 3000K | 4.0W | 310lm | Phase-Control
26506-L930-D9-PH-__
CRI>90 | 3000K | 6.0W | 500lm | Phase-Control
26506-M930-D9-PH-__

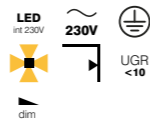

LED integrated

power: dependent on version
CRI: CRI>90
CCT: 2700K | 3000K | 4000K
dimming standard: Phase-Control

new

MAXI POINT square LED 230V spider wall

aqform.com/M10272

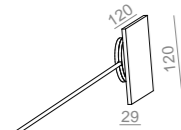

CRI>90 | 3000K | 4.0W | 310lm | Phase-Control
26507-L930-D9-PH-__
CRI>90 | 3000K | 6.0W | 500lm | Phase-Control
26507-M930-D9-PH-__

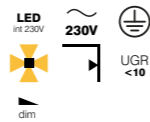

LED integrated

power: dependent on version
CRI: CRI>90
CCT: 2700K | 3000K | 4000K
dimming standard: Phase-Control

KARI

aqform.com/K10075

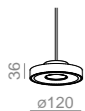

KARI LED 230V spider suspended module
CRI>90 | 3000K | 8.0W | 620lm | 36° | Phase-Control
50592-M930-F1-PH-__

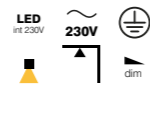

LED integrated

power: 8.0W
CRI: CRI>90
CCT: 2700K | 3000K | 4000K
beam angle: 36°
dimming standard: Phase-Control

all versions

all versions

MODERN GLASS SPIDER suspended

aqform.com/M11015

FLARED



BARREL

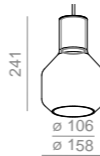

TUBE



LED: CRI>90 | 3000K | Phase-Control

shade	power	flux	cat. no
FLARED	transparent plain	6.0W	54568-M930-D9-PH-__
	transparent rhomb	6.0W	54577-M930-D9-PH-__
	white plain	6.0W	59741-M930-D9-PH-__
BARREL	transparent plain	6.0W	54569-M930-D9-PH-__
	transparent rhomb	6.0W	54578-M930-D9-PH-__
	white plain	6.0W	59742-M930-D9-PH-__
TUBE	transparent plain	6.0W	54567-M930-D9-PH-__
	transparent rhomb	6.0W	54576-M930-D9-PH-__
	white plain	6.0W	59740-M930-D9-PH-__

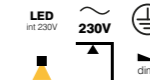

glass finishes

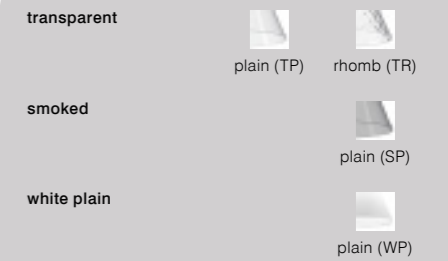

LED 230V integrated

power: 6.0W
CRI: CRI>90
CCT: 2700K | 3000K | 4000K
dimming standard: Phase-Control

PAR16, 230V: GU10 | max: LED 10.0W | Phase-Control

shade	cat. no	
FLARED	transparent plain	54562-0000-U8-PH-__
	transparent rhomb	54571-0000-U8-PH-__
	white plain	59735-0000-U8-PH-__
BARREL	transparent plain	54563-0000-U8-PH-__
	transparent rhomb	54572-0000-U8-PH-__
	white plain	59736-0000-U8-PH-__
TUBE	transparent plain	54561-0000-U8-PH-__
	transparent rhomb	54570-0000-U8-PH-__
	white plain	59734-0000-U8-PH-__

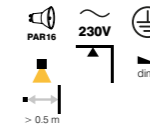

PAR16, 230V

power: max: LED 10.0W
dimming standard: Phase-Control
light source not included

E27, 230V: LED 13.0W | Phase-Control | light source not included

shade	cat. no	
FLARED	transparent plain	54565-0000-U8-PH-__
	transparent rhomb	54574-0000-U8-PH-__
	white plain	59738-0000-U8-PH-__
BARREL	transparent plain	54566-0000-U8-PH-__
	transparent rhomb	54575-0000-U8-PH-__
	white plain	59739-0000-U8-PH-__
TUBE	transparent plain	54564-0000-U8-PH-__
	transparent rhomb	54573-0000-U8-PH-__
	white plain	59737-0000-U8-PH-__

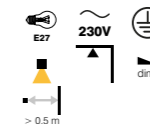

Standard E27, 230V

power: max: LED 13.0W
dimming standard: Phase-Control
light source not included

finishes for spider luminaires

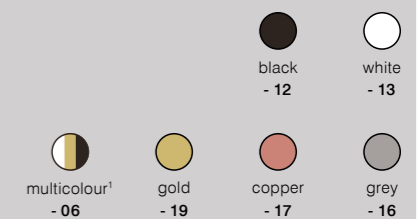

* Multicolour is available for PET next, PET next mini and KARI







system: MIXLINE





The MIXLINE system allows you to create personalized lighting compositions according to your own design. These lighting fixtures consist of modules containing power and lighting sections – linear or spot. Individual sections can be combined straight or angled, so we have complete freedom in creating an individual designs. Minimalist design and a variety of forms make the MIXLINE system luminaires perfectly accentuate the modern style of arrangement. They are available in three mounting versions: suspended, surface-mounted and recessed.

System MIXLINE umożliwia tworzenie spersonalizowanych kompozycji świetlnych według własnego projektu. Oprawy te składają się z modułów zawierających sekcje zasilające i świecące – liniowo bądź punktowo. Poszczególne odcinki można łączyć prosto lub kątowno, dzięki czemu mamy pełną dowolność w tworzeniu indywidualnych wzorów. Minimalistyczne wzornictwo oraz różnorodność form sprawiają, że oprawy systemowe MIXLINE doskonale akcentują nowoczesny styl aranżacji. Dostępne są w trzech wersjach montażowych: zwieszanej, natynkowej i wpuszczanej.



luminaire family

-  [p.082](#)
-  [p.150](#)
-  [p.210](#)

system: MIXLINE LED recessed

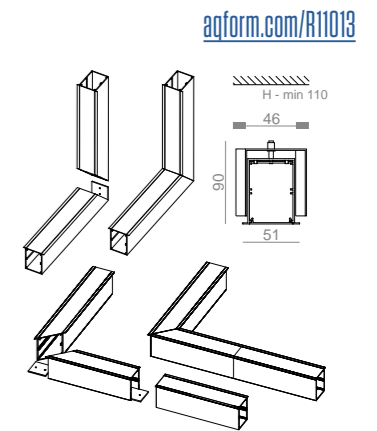

aqform.com/R11013

system: MIXLINE LED surface

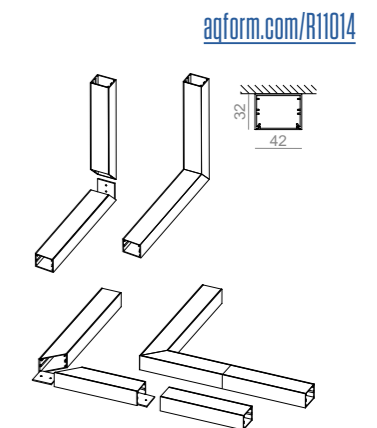

aqform.com/R11014

system: MIXLINE LED suspended

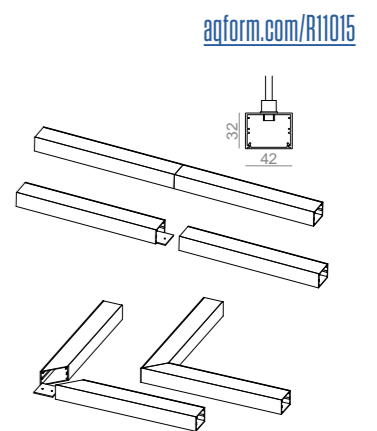

aqform.com/R11015

system components

lighting section / sekcja świecąca
power supply section / sekcja zasilająca
connectors / łączniki

light source: LED integrated

power: dependent on version
CRI: CRI>90
CCT: 2700K | 3000K | 4000K
beam angle: mixed: direct&diffused light
lens: 26° | 54°
dimming: optional: DALI/switchDIM, AQsmart

finishes

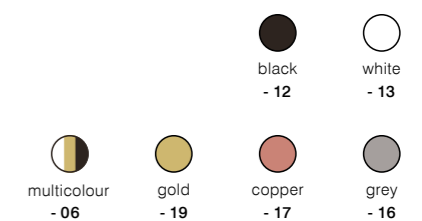

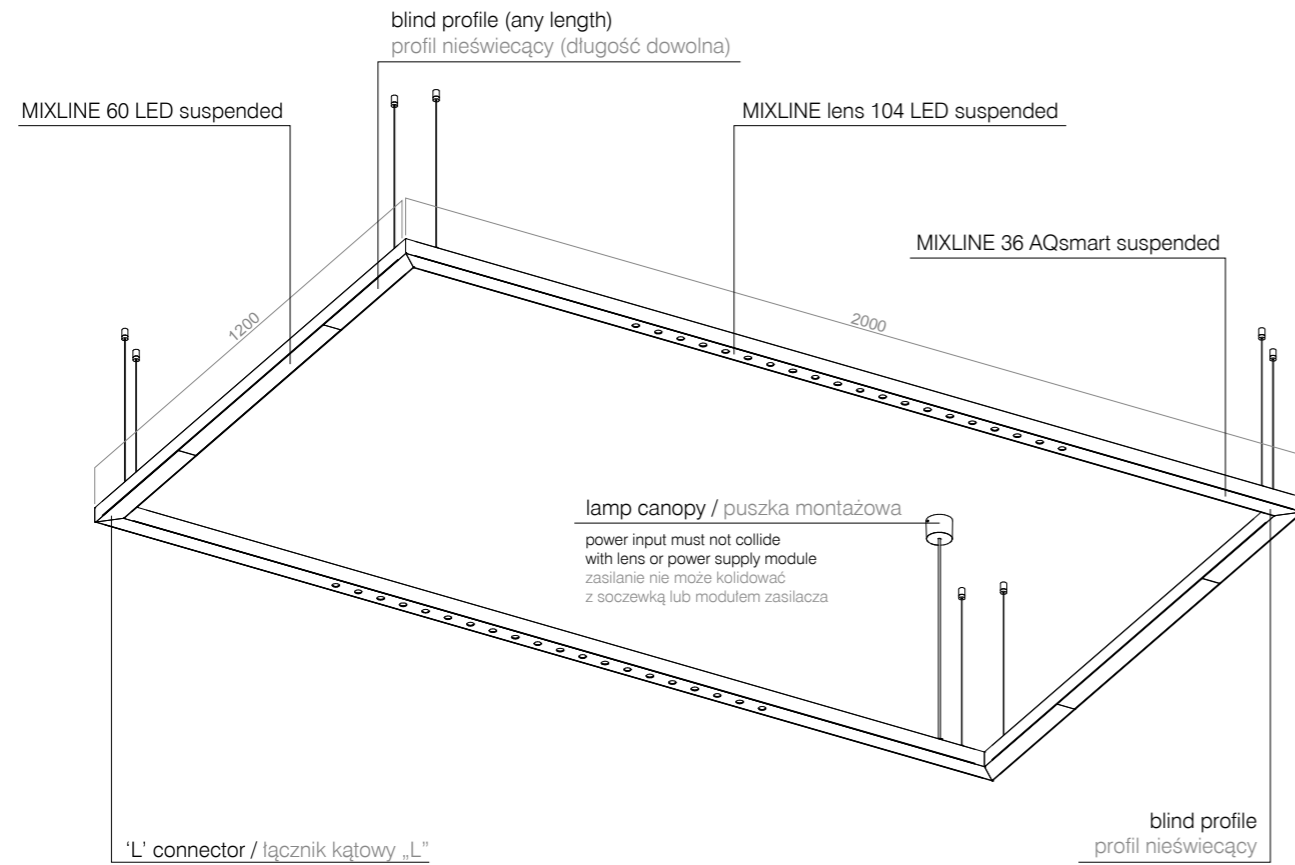
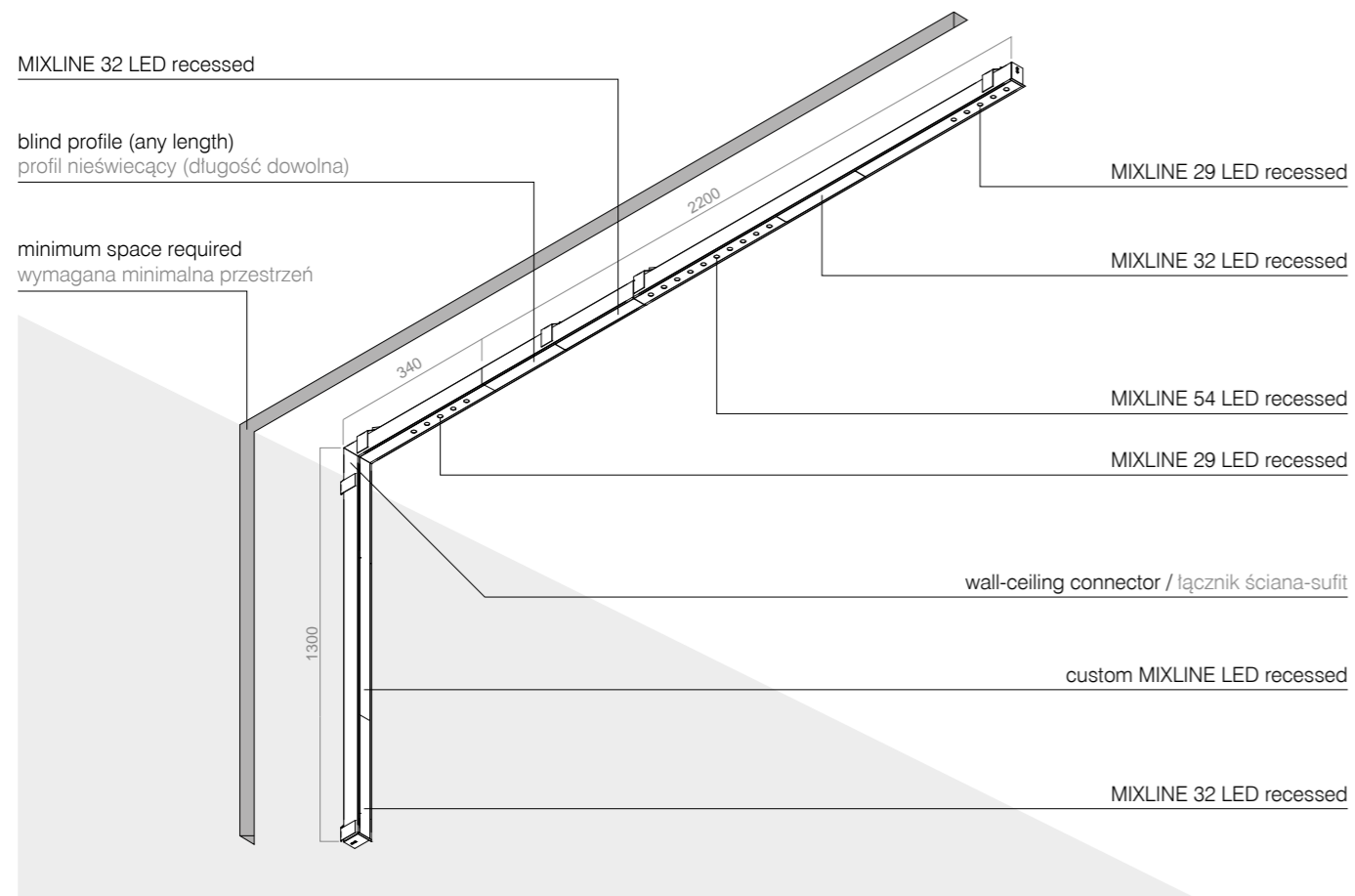









system: MIXLINE LED recessed

aqform.com/R11013

lighting section / sekcja świecąca data for 3000K and CRI>90 / dane dla 3000K oraz CRI>90 cat. no.

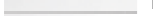
	MIXLINE 32 LED recessed 320mm power: 8.5W 1210lm	70097
	MIXLINE 60 LED recessed 600mm power: 17.5W 2430lm	70098
	MIXLINE 88 LED recessed 880mm power: 26.0W 3640lm	70099
	MIXLINE 116 LED recessed 1160mm power: 35.0W 4860lm	70100
	MIXLINE lens 29 LED recessed 290mm power: 3.5W 400lm	70101
	MIXLINE lens 54 LED recessed 540mm power: 7.0W 810lm	70102
	MIXLINE lens 79 LED recessed 790mm power: 10.5W 1220lm	70103
	MIXLINE lens 104 LED recessed 1040mm L power: 14.0W 1630lm	70104
	blind profile / profil nieświeący on request	70123

connectors / łączniki

	straight connector / łącznik prosty 70109		wall-ceiling connector / łącznik ściana-sufit 70111
	'L' connector / łącznik kątowy „L” 70110		

power supply section / sekcja zasilająca dimming dependent on power supply section / ściemnianie zależy od sekcji zasilającej

	MIXLINE 32 non DIM recessed non dim 320mm	70120
	MIXLINE 32 DIM recessed DALI/switchDIM 320mm	70107
	MIXLINE 36 AQsmart recessed AQsmart 360mm	70106

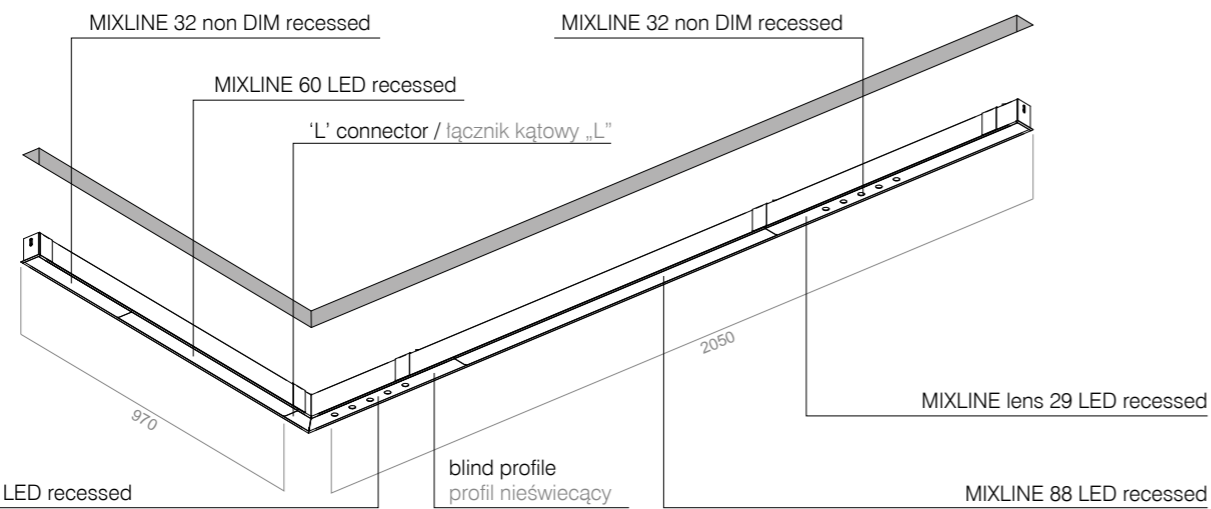

For one power supply section the minimum lighting segment length is 290mm. / Na jedną sekcję zasilającą minimalna długość odcinka świecącego to 290mm.
 The maximum length of a single section is 2200mm (including power supply section). / Maksymalna długość pojedynczego odcinka oprawy wynosi 2200mm (w tym sekcja zasilająca).
 For a system longer than 2200mm it is required to add more than one power supply section. / Dla systemu dłuższego niż 2200mm wymagana jest więcej niż jedna sekcja zasilająca.

On the connections of system elements which emit diffused light - separate covers meet. In the place where the covers are joined, up to 1000mm the dilatation ± 1 mm is left, and for covers over 1000mm the dilatation ± 2 mm is left. Dilatation is required due to the thermal expansion of the material. / Na połączeniach elementów systemu emitujących rozproszone światło stykają się osobne przestony. W miejscu łączenia przeston do 1000mm pozostawiana jest dylatacja ± 1 mm, przy przestonach powyżej 1000mm dylatacja ma ± 2 mm. Dylatacja wymagana jest ze względu na rozszerzalność temperaturową materiału.



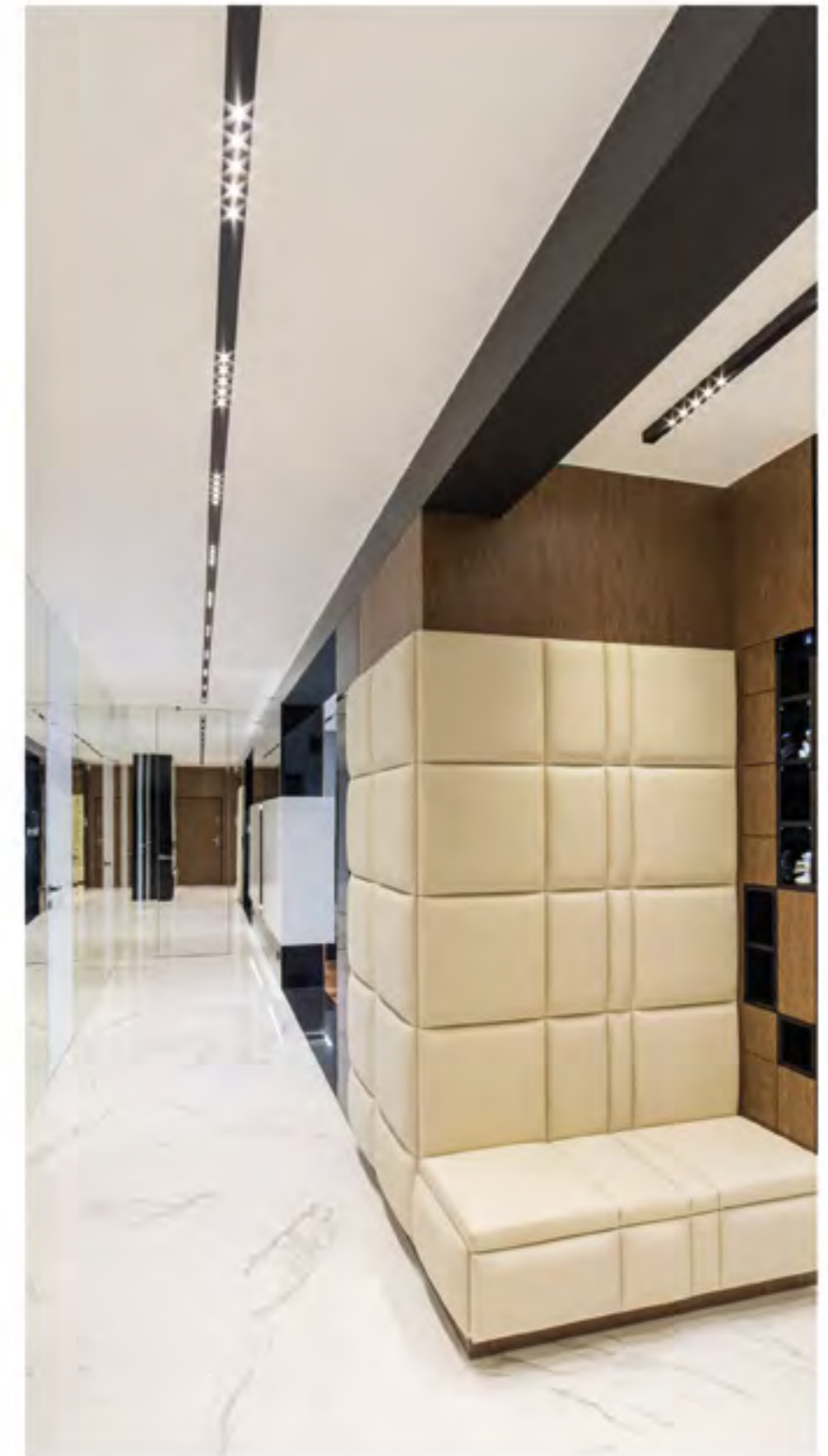



In case of angular connections of elements emitting diffused light, LED modules are not placed exactly in the corners, which may cause the formation of delicate shadows on the cover. / Przy łączeniu kątowym elementów emitujących światło rozproszone, moduły LED nie są umieszczane bezpośrednio w narożnikach, co może powodować powstawanie delikatnych cieni na przestonie.



system: MIXLINE LED surface

aqform.com/R11014

lighting section / sekcja świecąca data for 3000K and CRI>90 / dane dla 3000K oraz CRI>90 cat. no.

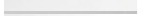
	MIXLINE 32 LED surface 320mm power: 8.5W 1210lm	70085
	MIXLINE 60 LED surface 600mm power: 17.5W 2430lm	70086
	MIXLINE 88 LED surface 880mm power: 26.0W 3640lm	70087
	MIXLINE 116 LED surface 1160mm power: 35.0W 4860lm	70088
	MIXLINE lens 29 LED surface 290mm power: 3.5W 400lm	70089
	MIXLINE lens 54 LED surface 540mm power: 7.0W 810lm	70090
	MIXLINE lens 79 LED surface 790mm power: 10.5W 1220lm	70091
	MIXLINE lens 104 LED surface 1040mm power: 14.0W 1630lm	70092
	blind profile / profil nieświeący on request	70122

connectors / łączniki

	straight connector / łącznik prosty 70109		wall-ceiling connector / łącznik ściana-sufit 70111
	'L' connector / łącznik kątowny „L” 70110		

power supply section / sekcja zasilająca dimming dependent on power supply section / ściemnianie zależy od sekcji zasilającej

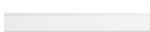
	MIXLINE 32 non DIM recessed non dim 320mm	70119
	MIXLINE 32 DIM recessed DALI/switchDIM 320mm	70095
	MIXLINE 36 AQsmart recessed AQsmart 360mm	70094

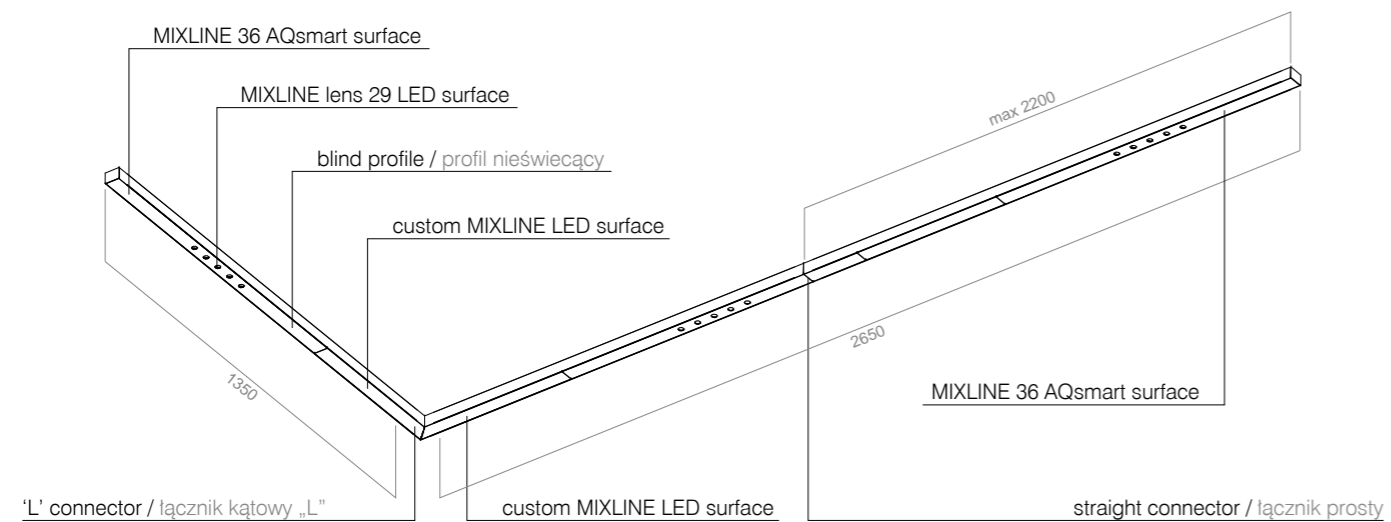

For one power supply section the minimum lighting segment length is 290mm. / Na jedną sekcję zasilającą minimalna długość odcinka świecącego to 290mm.
 The maximum length of a single section is 2200mm (including power supply section). / Maksymalna długość pojedynczego odcinka oprawy wynosi 2200mm (w tym sekcja zasilająca).
 For a system longer than 2200mm it is required to add more than one power supply section. / Dla systemu dłuższego niż 2200mm wymagana jest więcej niż jedna sekcja zasilająca.





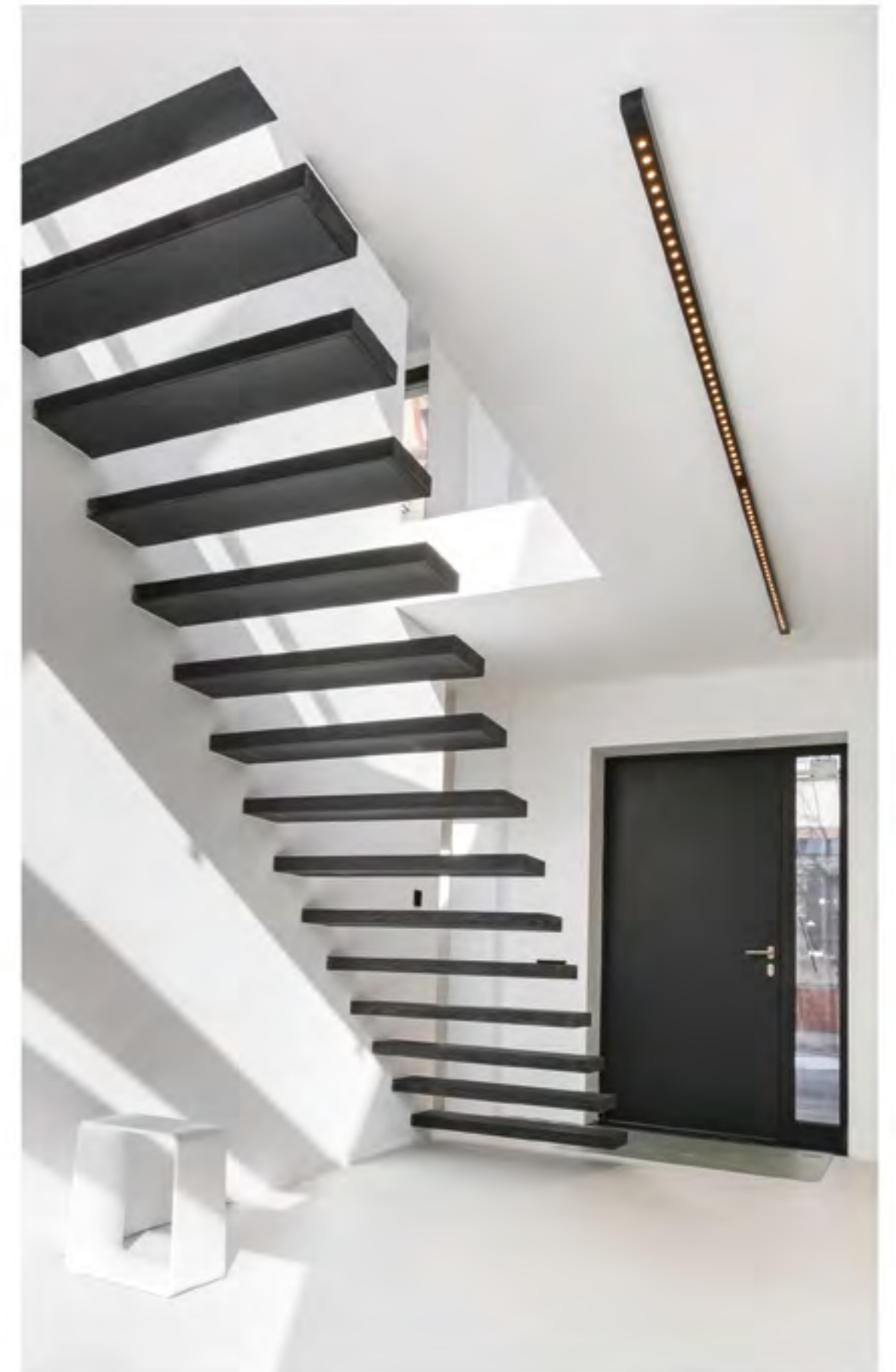

On the connections of system elements which emit diffused light - separate covers meet. In the place where the covers are joined, up to 1000mm the dilatation ± 1 mm is left, and for covers over 1000mm the dilatation ± 2 mm is left. Dilatation is required due to the thermal expansion of the material. / Na łączeniach elementów systemu emitujących rozproszone światło stykają się osobne przestony. W miejscu łączenia przeston do 1000mm pozostawiana jest dylatacja ± 1 mm, przy przestonach powyżej 1000mm dylatacja ma ± 2 mm. Dylatacja wymagana jest ze względu na rozszerzalność temperaturową materiału.

In case of angular connections of elements emitting diffused light, LED modules are not placed exactly in the corners, which may cause the formation of delicate shadows on the cover. / Przy łączeniu kątowym elementów emitujących światło rozproszone, moduły LED nie są umieszczane bezpośrednio w narożnikach, co może powodować powstawanie delikatnych cieni na przestonie.





system: MIXLINE LED suspended

aqform.com/R11015

lighting section / sekcja świecąca	data for 3000K and CRI>90 / dane dla 3000K oraz CRI>90	cat. no.
 MIXLINE 32 LED suspended	320mm power: 8.5W 1210lm	70071
 MIXLINE 60 LED suspended	600mm power: 17.5W 2430lm	70072
 MIXLINE 88 LED suspended	880mm power: 26.0W 3640lm	70073
 MIXLINE 116 LED suspended	1160mm power: 35.0W 4860lm	70074
 MIXLINE lens 29 LED suspended	290mm power: 3.5W 400lm	70075
 MIXLINE lens 54 LED suspended	540mm power: 7.0W 810lm	70076
 MIXLINE lens 79 LED suspended	790mm power: 10.5W 1220lm	70077
 MIXLINE lens 104 LED suspended	1040mm power: 14.0W 1630lm	70078
 blind profile / profil nieświecący	on request	70121

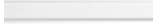
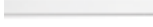
connectors / łączniki		
 straight connector / łącznik prosty	70109	
 'L' connector / łącznik kątowy „L”	70110	

power supply section / sekcja zasilająca	dimming dependent on power supply section / ściemnianie zależy od sekcji zasilającej	
 MIXLINE 32 non DIM suspended	non dim 320mm with lamp canopy Φ 50mm / z puszką zasilającą Φ 50mm	70118
 MIXLINE 32 DIM suspended	DALI/switchDIM 320mm with lamp canopy Φ 100mm / z puszką zasilającą Φ 100mm	70081
 MIXLINE 36 AQsmart suspended	AQsmart 360mm with lamp canopy Φ 50mm / z puszką zasilającą Φ 50mm	70080

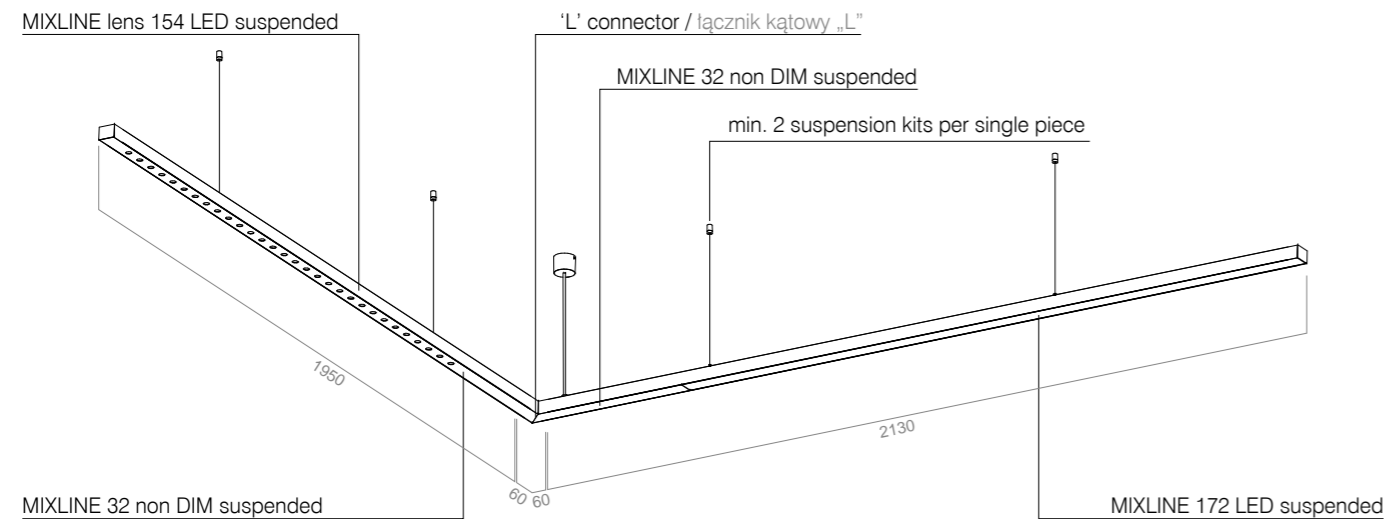

For one power supply section the minimum lighting segment length is 290mm. / Na jedną sekcję zasilającą minimalna długość odcinka świecącego to 290mm.
 The maximum length of a single section is 2200mm (including power supply section). / Maksymalna długość pojedynczego odcinka oprawy wynosi 2200mm (w tym sekcja zasilająca).
 For a system longer than 2200mm it is required to add more than one power supply section. / Dla systemu dłuższego niż 2200mm wymagana jest więcej niż jedna sekcja zasilająca.

On the connections of system elements which emit diffused light - separate covers meet. In the place where the covers are joined, up to 1000mm the dilatation \pm 1mm is left, and for covers over 1000mm the dilatation \pm 2mm is left. Dilatation is required due to the thermal expansion of the material. / Na łączeniach elementów systemu emitujących rozproszone światło stykają się osobne przestony. W miejscu łączenia przeston do 1000mm pozostawiana jest dylatacja \pm 1mm, przy przestonach powyżej 1000mm dylatacja ma \pm 2mm. Dylatacja wymagana jest ze względu na rozszerzalność temperaturową materiału.

In case of angular connections of elements emitting diffused light, LED modules are not placed exactly in the corners, which may cause the formation of delicate shadows on the cover. / Przy łączeniu kątowym elementów emitujących światło rozproszone, moduły LED nie są umieszczane bezpośrednio w narożnikach, co może powodować powstawanie delikatnych cieni na przestonie.

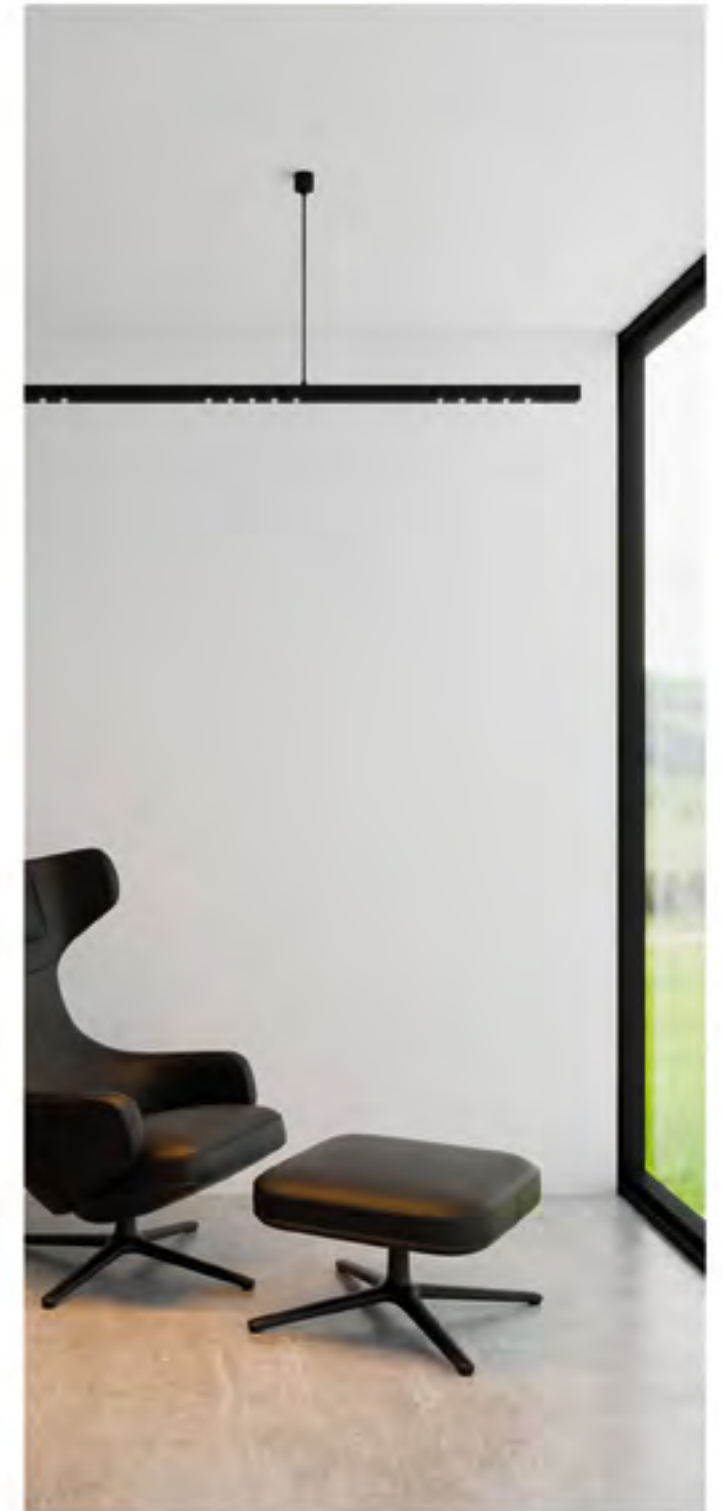

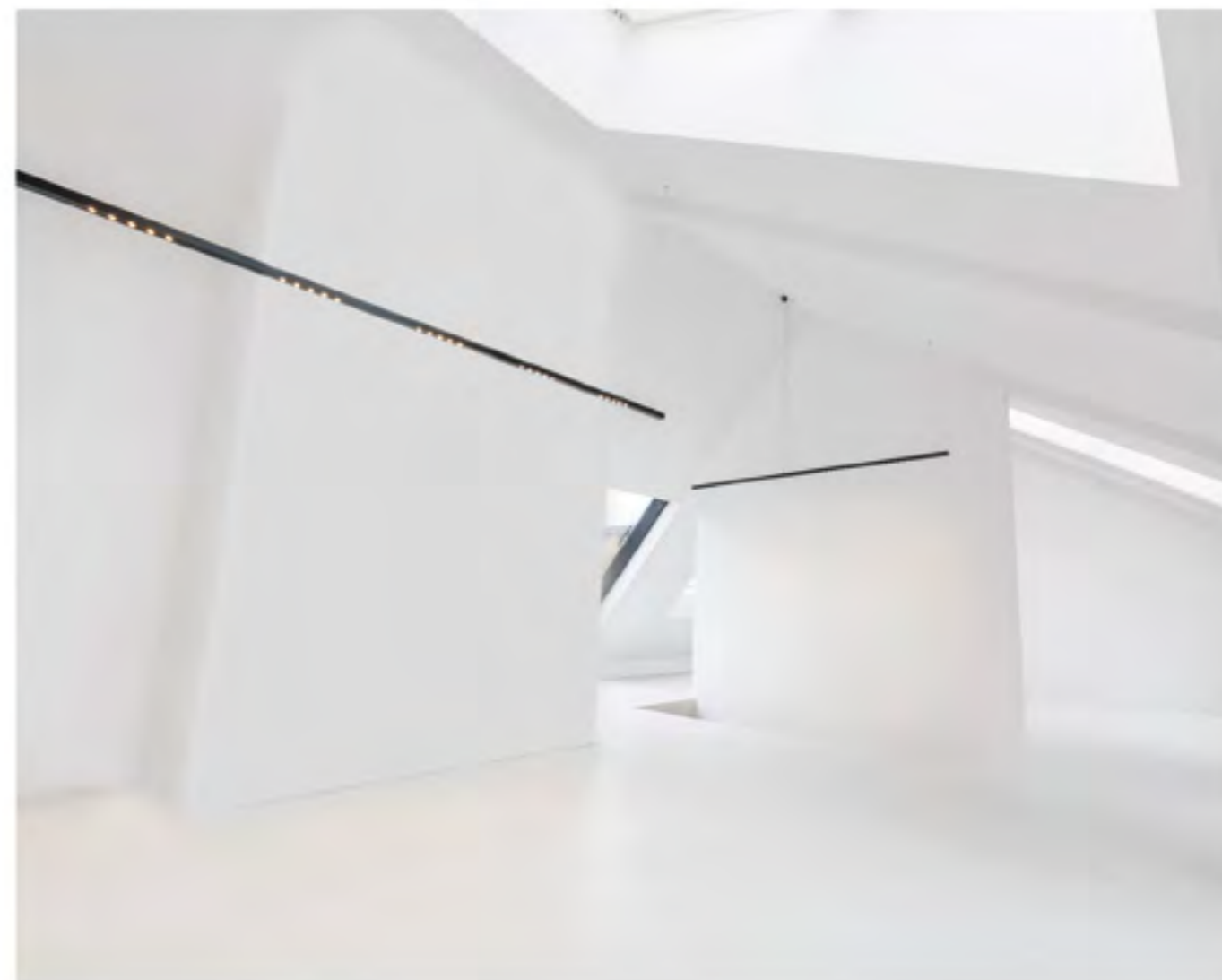

system: RAW mini



Thanks to the light form and minimalist design, the RAW mini system is a coherent element of modern interiors. Subtle design and a neat, geometric form emphasize the prestigious nature of the arrangement. The ability to connect individual sections in a linear or right angle way, allows you to create compositions according to your own design. The RAW mini system works well in both private and commercial spaces – it shows the way in communication zones, as well as effectively brightens large office or hotel spaces, emitting a pleasant, diffused light.

Dzięki lekkiej formie oraz minimalistycznemu wzornictwu, system RAW mini stanowi spójny element nowoczesnych wnętrz. Subtelne wzornictwo oraz zgrabna, geometryczna forma podkreślają prestiżowy charakter aranżacji. Możliwość łączenia poszczególnych odcinków w sposób liniowy lub pod kątem prostym pozwala na tworzenie kompozycji według własnego projektu. System RAW mini sprawdza się zarówno w przestrzeniach prywatnych, jak i komercyjnych – wyznacza drogę w strefach komunikacyjnych, a także skutecznie rozświetla duże przestrzenie biurowe lub hotelowe, emitując przyjemne, rozproszone światło.

function



luminaire family

-  [p.086](#)
-  [p.302](#)
-  [p.156](#)
-  [p.376](#)
-  [p.214](#)

system: RAW mini recessed

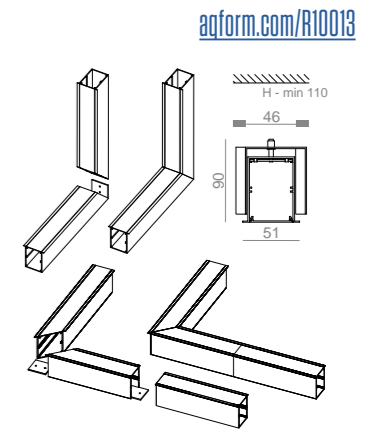
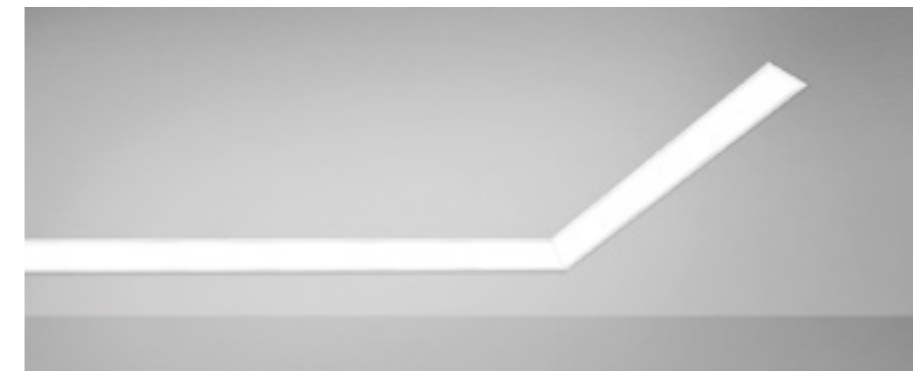

The minimum length of a connectable segment is 290mm / Minimalna długość jednego odcinka to 290mm
The maximum length of a connectable segment is 2200mm / Maksymalna długość jednego odcinka to 2200mm

light source: LED integrated

power: L power version | M power version
CRI: >90
CCT: 2700K | 3000K | 4000K
dimming: dependent on version

LED modules



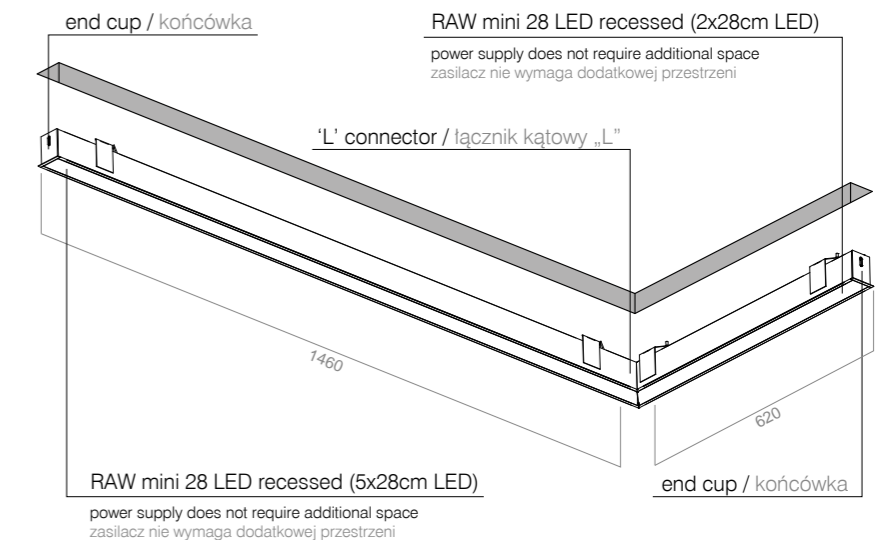

-  module LED 560mm
L power: 9.0W, 1200lm | M power: 16.0W, 2420lm
-  module LED 280mm
L power: 4.5W, 600lm | M power: 8.5W, 1210lm
-  module LED 140mm
L power: 2.5W, 300lm | M power: 4.5W, 600lm



On the connections of system elements which emit diffused light - separate covers meet. In the place where the covers are joined, up to 1000mm the dilatation ± 1 mm is left, and for covers over 1000mm the dilatation ± 2 mm is left. Dilatation is required due to the thermal expansion of the material. / Na łączeniach elementów systemu emitujących rozproszone światło stykają się osobne przesłony. W miejscu łączenia przesłon do 1000mm pozostawiana jest dylatacja ± 1 mm, przy przesłonach powyżej 1000mm dylatacja ma ± 2 mm. Dylatacja wymagana jest ze względu na rozszerzalność temperaturową materiału.

In case of angular connections of elements emitting diffused light, LED modules are not placed exactly in the corners, which may cause the formation of delicate shadows on the cover. / Przy łączeniu kątowym elementów emitujących światło rozproszone, moduły LED nie są umieszczane bezpośrednio w narożnikach, co może powodować powstawanie delikatnych cieni na przesłonie.

finishes

-  black - 12
-  white - 13
-  gold - 19
-  copper - 17
-  grey - 16

Data for standard product is shown for LED light source 3000K. Other variants available on our website.

system: TRU



Kraków | lighting design: Light Project4U Joanna Raszewska-Sztorc

Efficient and elegant in its simplicity. Thanks to the availability of high power, TRU works especially well in larger rooms. Together with the new PRO version, it allows you to easily achieve very high visual comfort. Thanks to the Tunable-White and AQsmart systems, the luminaire can adapt to the time of day and the natural needs of people. It allows you to use almost any control protocol and renders colours well. Thanks to the use of an additional reflector, it is extremely efficient and at the same time allows you to save energy and take care of the environment.

Wydajny i elegancki w swojej prostocie. Dzięki dostępności wysokich mocy, TRU szczególnie dobrze spisuje się w większych pomieszczeniach. Wraz z nową wersją PRO pozwala na łatwe uzyskanie bardzo wysokiego komfortu wizualnego. Dzięki systemom Tunable-White i AQsmart, oprawa potrafi dostosować się do pory dnia i naturalnych potrzeb ludzi. Pozwala na wykorzystanie niemal dowolnego protokołu sterowania i dobrze odwzorowuje barwy. Dzięki stosowaniu dodatkowego odbłyśnika jest niezwykle wydajny i pozwala równocześnie oszczędzać energię oraz zadbać o środowisko.



function

luminaire family

- | | |
|---|---|
|  p.098 |  p.272 |
|  p.164 |  p.332 |
|  p.218 |  p.378 |

system: TRU LED suspended



system: TRU LED wall



system: TRU LED surface



system: TRU LED recessed



system: TRU up&down LED suspended





system: TRU up&down LED wall









light source: LED integrated

power: L power version | M power version
 CRI: CRI>90
 CCT: 2700K | 3000K | 4000K
 dimming: dependent on version

LED modules

-  module LED 560mm
L power: 9.0W, 1200lm | M power: 16.0W, 2420lm
-  module LED 280mm
L power: 4.5W, 600lm | M power: 8.5W, 1210lm
-  module LED 140mm
L power: 2.5W, 300lm | M power: 4.5W, 600lm

finishes

- | | | | | |
|---|--|--|---|--|
|  multicolour
- 06 |  gold
- 19 |  copper
- 17 |  white
- 13 |  grey
- 16 |
|  black
- 12 | | | | |

CONNECTORS / ŁĄCZNIKI

straight connector / łącznik prosty

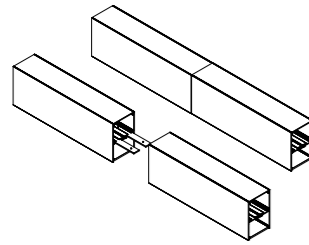

'T' connector / łącznik „T”

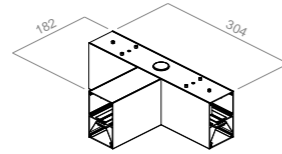

angular connector (90°) / łącznik kątowy (90°)

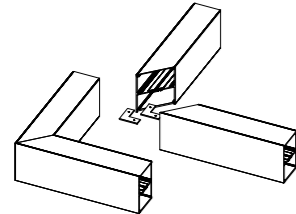

'X' connector (90°) / łącznik „X” (90°)

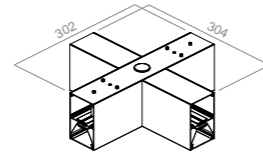

system TRU does not require additional space for power supplies
system TRU nie wymaga dodatkowej przestrzeni na zasilacze

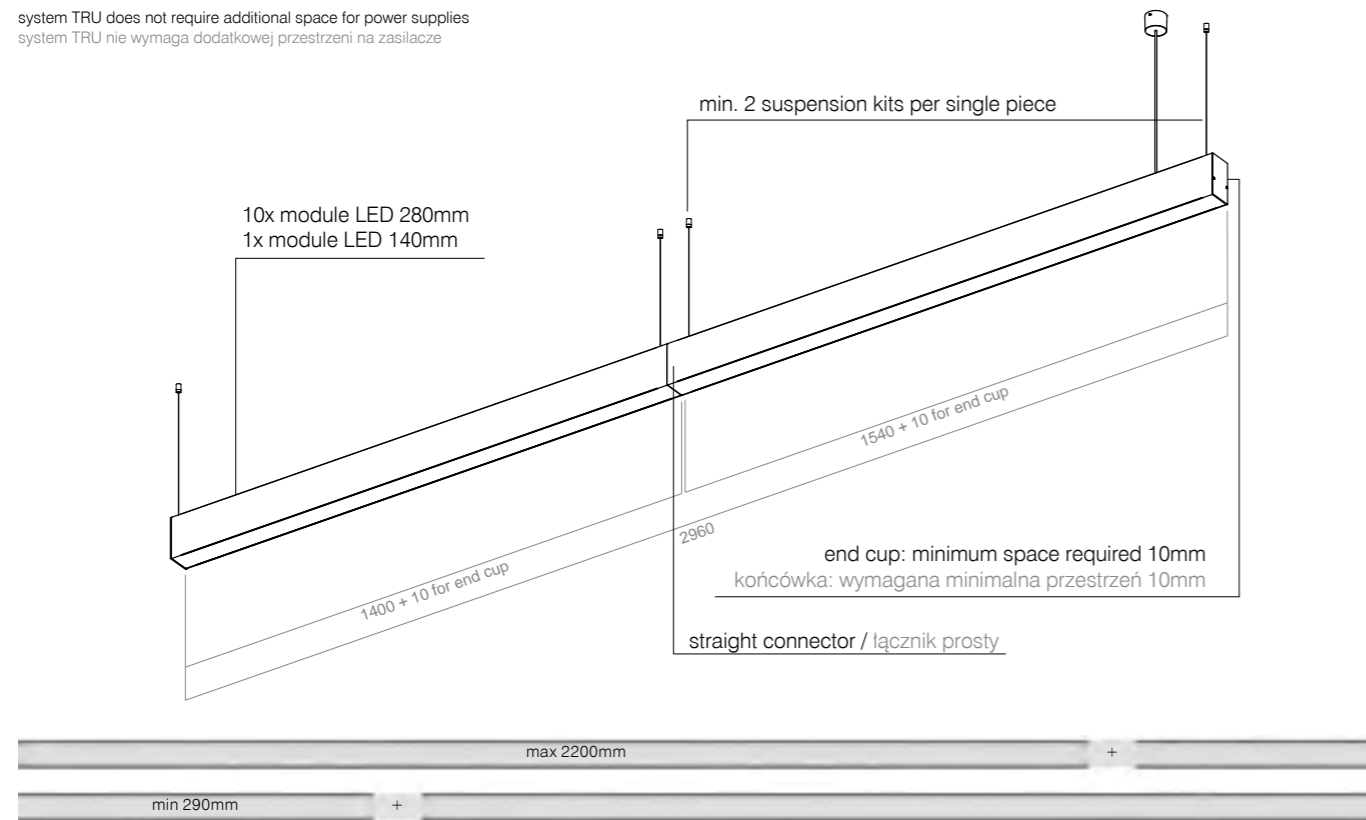

The minimum length of a connectable segment is 290mm. / Minimalna długość jednego odcinka to 290mm.
The maximum length of a connectable segment is 2200mm. / Maksymalna długość jednego odcinka to 2200mm.

On the connections of system elements which emit diffused light - separate covers meet. In the place where the covers are joined, up to 1000mm the dilatation ± 1 mm is left, and for covers over 1000mm the dilatation ± 2 mm is left. Dilatation is required due to the thermal expansion of the material. / Na łączeniach elementów systemu emitujących rozproszone światło stykają się osobne przestony. W miejscu łączenia przestony do 1000mm pozostawiana jest dylatacja ± 1 mm, przy przestonach powyżej 1000mm dylatacja ma ± 2 mm. Dylatacja wymagana jest ze względu na rozszerzalność temperaturową materiału.

In case of angular connections of elements emitting diffused light, LED modules are not placed exactly in the corners, which may cause the formation of delicate shadows on the cover. / Przy łączeniu kątowym elementów emitujących światło rozproszone, moduły LED nie są umieszczane bezpośrednio w narożnikach, co może powodować powstawanie delikatnych cieni na przestonie.



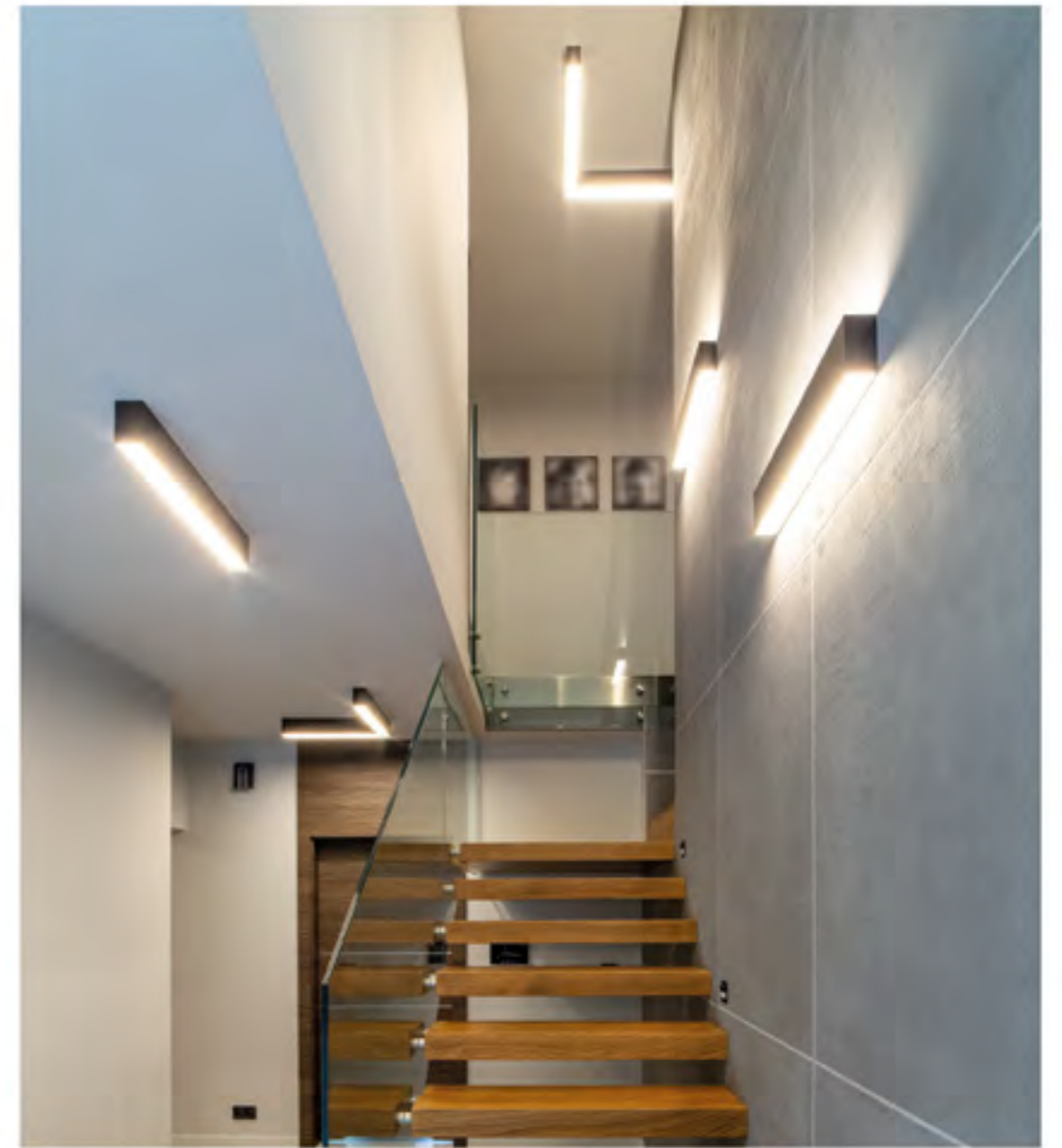

Other solution needed? Check out RAFTER or contact us.

RAFTER power supply does not require additional space
zasilacz RAFTER nie wymaga dodatkowej przestrzeni

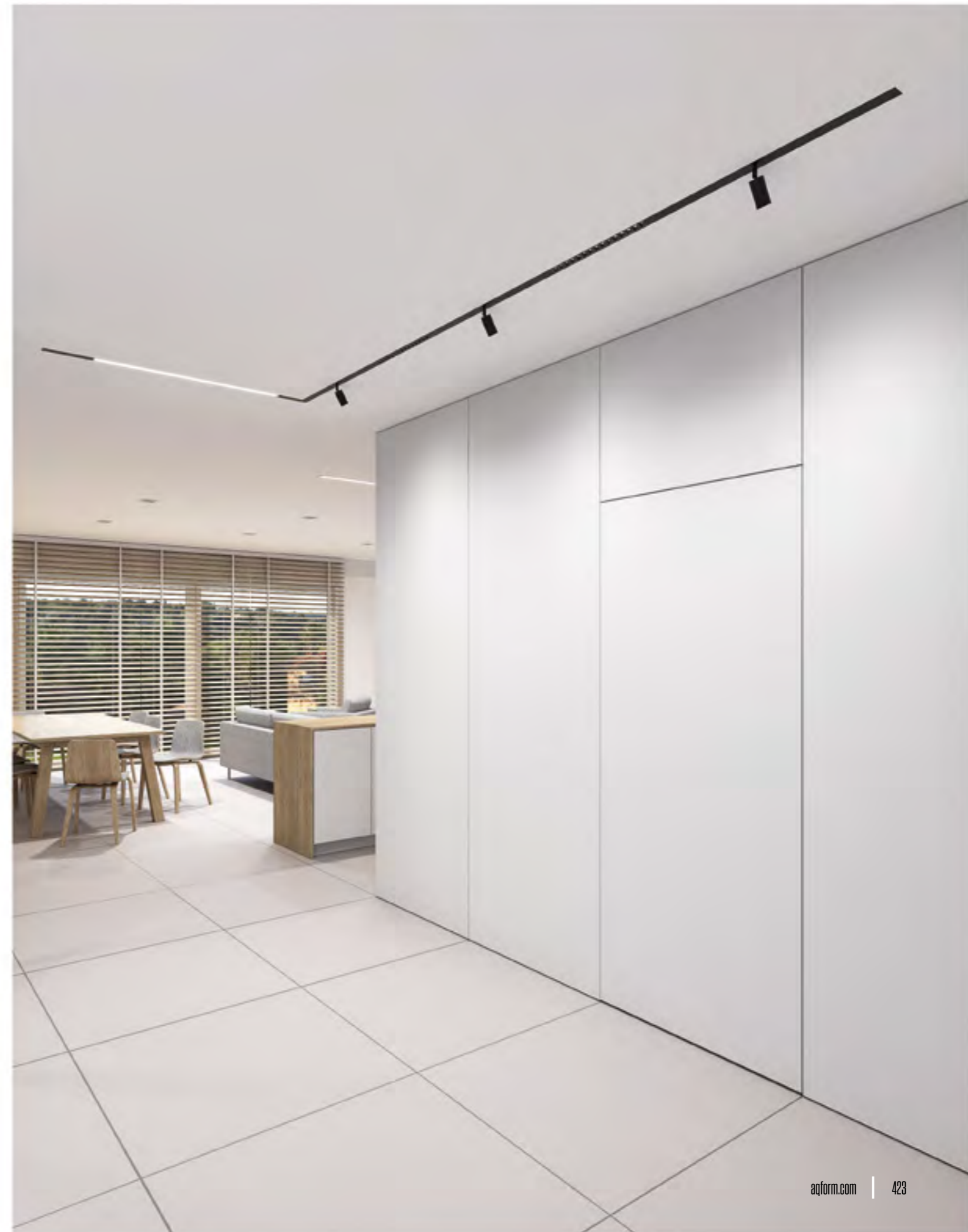
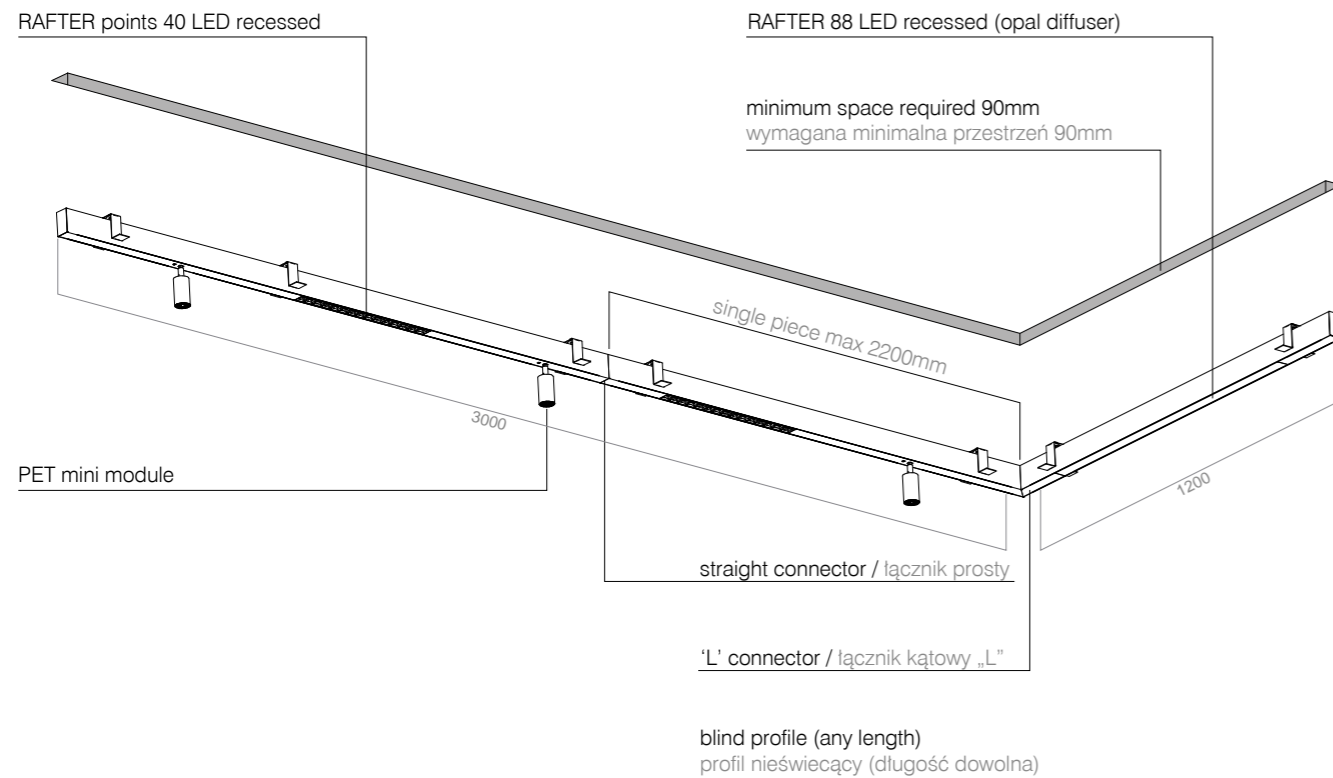



INDEX

Luminaires index by name / indeks opraw według nazw

#

1000 PRO LED track	PR1016	NEW	236
1000 PRO LED multitrack	PR1017	NEW	236
1000 PRO LED spot	PR1011	NEW	236
2000 P20 spot	10011		240
2000 P20 track	10111		240
2000 P30 spot	10311		240
2000 P30 track	10411		240
2000 PRO LED multitrack	PR4017	NEW	238
2000 PRO LED spot	PR4011	NEW	238
2000 PRO LED track	PR4016	NEW	238

A

AQLED lens 230V track	AQ0146		264
AQLED move lens 230V spot	AL8041		264
AQLED move spot	AL8051		264

B

BASET LED wall	BA0012		328
BIG SIZE next round LED recessed	BS1113		078
BIG SIZE next round LED surface	BS1114		142
BIG SIZE next round LED suspended	BS1115		200
BIG SIZE next square LED recessed	BS1213		080
BIG SIZE next square LED surface	BS1214		144
BIG SIZE next square LED suspended	BS1215		202
BIG SIZE PRO next round LED recessed	BS1113		078
BIG SIZE PRO next round LED surface	BS1114		142
BIG SIZE PRO next round LED suspended	BS1115		200
BIG SIZE PRO next square LED recessed	BS1213		080
BIG SIZE PRO next square LED surface	BS1214		144
BIG SIZE PRO next square LED suspended	BS1215		202
BLOS 2 LED surface	BL2014		370
BLOS LED hermetic surface	BL0014		370
BLOS mini LED hermetic surface	BL1014		370
BLOS round 32 LED hermetic surface	BL1114		370
BLOS round 40 LED hermetic surface	BL2114		370

C

CADRA 111x1 230V suspended	54611		198
CADRA 111x1 230V wall	24311		326
CADRA 111x2 230V suspended	54712		198
CADRA 111x2 230V wall	24412		326
CADRA 111x3 230V suspended	54813		198
CADRA 111x4 230V suspended	54914		198
CADRA 111x4 SQ 230V suspended	55014		198
CAMBER mini square LED wall	CA1112	NEW	298
CERES 111 plus QRLED spot	CE1061		254

CERES 111 plus spot	14411		256
CERES 111 QRLED 230V spot	CE2061		254
CERES 111 QRLED 230V track	CE2066		254
CERES 111 spot	14311		256
CERES 111 track	14511		256
CERES 111x1 R QRLED spot	CE3161		254
CERES 111x1 R spot	15611		256
CERES 111x2 R QRLED spot	CE3261		254
CERES 111x2 R spot	15112		256
CERES 111x3 R QRLED spot	CE3361		254
CERES 111x3 R spot	15213		256

E

equilibra BALANS LED suspended	EQ0011		204
equilibra CENTRAL DIRECT LED suspended	EQ0231		204
equilibra DIRECT 17 LED 230V wall	EQ1012		338
equilibra DIRECT LED surface	EQ0032		146
equilibra DIRECT LED suspended	EQ0031		204
equilibra DIRECT LED wall	EQ0033		338
equilibra SOFT LED surface	EQ0022		146
equilibra SOFT LED suspended	EQ0021		204
equilibra SOFT LED wall	EQ0023		338

G

GLOB simple suspended	50120		188
GOLO LED hermetic wall	GL0012	NEW	294
GRAPH LED 230V wall	GR0012		322

H

HOLLOW micro LED recessed	HL0013	NEW	042
HOLLOW mini LED recessed	HL1013	NEW	042
HOLLOW x1 round LED recessed	HL4213		042

K

KARI 11 LED multitrack	KA0017		260
KARI 17x2 LED 230V spot	KA4071		260
KARI LED 230V spot	KA0071		260
KARI LED 230V suspended	KA0075		260
KARI LED 230V track	KA0076		260
KARI LED DALI track	KA0096		260
KARI LED suspended multitrack	KA0517		260

L

LED EYE hermetic recessed	LE0803		358
LEDPOINT round LED 230V wall	LP0112		308
LEDPOINT round LED 230V wall G/K	LP6112		308
LEDPOINT square LED 230V wall	LP0212		308
LEDPOINT square LED 230V wall G/K	LP6212		308
LENS LINE 180x89 LC suspended	LL4015		208
LENS LINE 180x89 RC LED recessed	LL3013		082

LENS LINE 180x89 RC LED surface	LL3014	148
LENS LINE 180x89 RC suspended	LL3015	208
LENS LINE 43 LED recessed	LL0013	082
LENS LINE 53 LED surface	LL0014	148
LENS LINE 89x89 SQ LED surface	LL5014	148
LENS LINE 89x89 SQ suspended	LL5015	208
LENS LINE LED section recessed	LL0613	082
LENS LINE LED section surface	LL0614	148
LENS LINE section LED suspended	LL0615	208

M

MAXI CUBE LED 230V hermetic surface	MC0814	368
MAXI CUBE LED 230V hermetic wall	MC0812	368
MAXI CUBE LED 230V wall	MC0012	316
MAXI CUBE wall	22411	316
MAXI POINT round LED 230V wall	MP0172	306
MAXI POINT round LED 230V wall G/K	MP6172	306
MAXI POINT square LED 230V wall	MP0272	306
MAXI POINT square LED 230V wall G/K	MP6272	306
MAXI RING dot LED 230V surface	MR1074	126
MAXI RING dot LED 230V suspended	MR1075	184
MAXI RING LED recessed	MR0013	076
MAXI RING LED surface	MR0014	126
MAXI RING LED suspended	MR0015	184
MINI CUBE LED 230V wall	MC1012	316
MINI CUBE LED 230V wall G/K	MC6012	316
MINISQUARE x1 230V recessed	30019	070
MINISQUARE x2 230V recessed	30018	070
MIXLINE 120x89 RT LED surface	MX2014	150
MIXLINE 120x89 RT LED suspended	MX2015	210
MIXLINE INV LED recessed	MX1013	082
MIXLINE INV LED surface	MX1014	150
MIXLINE INV LED suspended	MX1015	210
MIXLINE LED recessed	MX0013	082
MIXLINE LED surface	MX0014	150
MIXLINE LED suspended	MX0015	210
MODERN BALL WP LED surface	MB1014	NEW 104 / 288
MODERN BALL WP LED suspended	MB1015	NEW 170
MODERN BALL WP x2 LED surface	MB2014	NEW 104 / 288
MODERN BALL WP x2 LED suspended	MB2015	NEW 170
MODERN BALL WP x3 LED section surface	MB3614	NEW 104
MODERN BALL WP x3 LED section suspended	MB3615	NEW 170
MODERN BALL WP x3 LED surface	MB3014	NEW 104
MODERN BALL WP x3 LED suspended	MB3015	NEW 170
MODERN BALL WP x4 LED asymmetry surface	MB4414	NEW 104
MODERN BALL WP x4 LED asymmetry suspended	MB4415	NEW 170
MODERN BALL WP x4 LED surface	MB4014	NEW 104
MODERN BALL WP x4 LED suspended	MB4015	NEW 170
MODERN BALL WP x5 LED surface	MB5014	NEW 104
MODERN BALL WP x5 LED suspended	MB5015	NEW 170
MODERN GLASS Barrel E27 surface	MG1024	112
MODERN GLASS Barrel E27 suspended	MG1025	178
MODERN GLASS Barrel GU10 surface	MG1034	112
MODERN GLASS Barrel GU10 suspended	MG1035	178
MODERN GLASS Barrel LED 230V surface	MG1014	112
MODERN GLASS Barrel LED 230V suspended	MG1015	178
MODERN GLASS Flared E27 surface	MG2024	110
MODERN GLASS Flared E27 suspended	MG2025	176

MODERN GLASS Flared GU10 surface	MG2034	110
MODERN GLASS Flared GU10 suspended	MG2035	176
MODERN GLASS Flared LED 230V surface	MG2014	110
MODERN GLASS Flared LED 230V suspended	MG2015	176
MODERN GLASS Tube E27 surface	MG3024	112
MODERN GLASS Tube E27 suspended	MG3025	178
MODERN GLASS Tube GU10 surface	MG3034	112
MODERN GLASS Tube GU10 suspended	MG3035	178
MODERN GLASS Tube LED 230V surface	MG3014	112
MODERN GLASS Tube LED 230V suspended	MG3015	178
MODERN GLASS Tube TP LED 230V wall	MG3012	292
MODERN GLASS Tube SP LED 230V wall	MG3012	292
MODERN GLASS Tube TR LED 230V wall	MG3412	292
MODERN GLASS Tube WP LED 230V wall	MG3012	NEW 292
MODERN GLASS Tube LED 230V hermetic wall	MG3812	NEW 352
MORE maxi LED recessed	MR3013	NEW 052
MORE midi LED recessed	MR2013	NEW 052
MORE mini LED recessed	MR1013	NEW 052
MORPH flared LED suspended	MH0215	182

O

ONLY round 6 LED 230V hermetic surface	ON1814	356
ONLY round 6 LED 230V surface	ON0114	116
ONLY round mini 10 LED 230V surface	ON1014	116
ONLY round mini LED 230V hermetic recessed	ON1873	NEW 356
ONLY round mini LED 230V hermetic surface	ON1874	356
ONLY square LED 230V surface	ON0214	116
ONLY square mini LED 230V hermetic recessed	ON2873	NEW 356

P

PET LED 230V hermetic surface	PE0874	362
PET micro move LED wall	PE2012	NEW 300
PET next LED multitrack	PE0817	NEW 230
PET next LED spot	PP0811	NEW 228
PET next LED surface	PE0814	NEW 106
PET next LED suspended	PE0815	NEW 174
PET next LED track	PP0816	NEW 230
PET next maxi LED spot	PE2811	NEW 228
PET next maxi LED surface	PE2814	NEW 106
PET next maxi LED suspended	PE2815	NEW 174
PET next mini 7x1 LED multitrack	PE3817	NEW 230
PET next mini LED spot	PE1811	NEW 228
PET next mini LED surface	PE1814	NEW 106
PET next mini LED suspended	PE1815	NEW 174
PET next mini LED track	PE1816	NEW 230
PET next mini LED suspended multitrack	PE1817	NEW 230
PET surface	PE9034	106
PET suspended	PE9035	174
PET zoom LED 230V surface	PE2074	106
PET zoom LED 230V suspended	PE2075	174
PET zoom LED 230V track	PE2116	232
PET zoom LED DALI track	PE2196	NEW 232
PETPOT next LED spot	PP2811	228
PETPOT next LED track	PP2816	230
PETPOT next mini LED spot	PP1811	228
PETPOT zoom LED 230V spot	PP2111	232

PETPOT zoom LED 230V track	PP2116		232
PETPOT zoom LED DALI track	PP2196	NEW	232
PEX LED 230V hermetic wall	PX0012		364
PEX up&down LED 230V hermetic wall	PX1012		364
POCKET mini LED wall	PC1012		312

Q

QRLED mini LED suspended multitrack	QR9517		248
QRLED mini move lens 230V spot	QR9071		248
QRLED mini move lens 230V track	QR9076		248
QRLED mini move lens multitrack	QR9017		248
QRLED move 230V spot	QR8161		250
QRLED move 230V track	QR8166		250
QRLED move multitrack	QR8067		250
QRLED move spot	QR8061		250
QRLED move track	QR8066		250
QUPET 12 LED 230V suspended	QU0075		196
QUPET mini LED sufrage	QU1014		130
QUPET mini LED suspended	QU1015		196
QUPET mini LED track	QU1016		246
QUPET mini LED wall	QU1012		314
QUPET surface	QU9034		130
QUPET suspended	51411		196

R

RAFTER 29 LED multitrack	RA0017	NEW	268
RAFTER LED recessed	RA0013		094
RAFTER LED surface	RA0014		158
RAFTER LED suspended	RA0015		216
RAFTER LED track	RA0016	NEW	268
RAFTER LED wall	RA0012		336
RAFTER mix LED recessed	RA9013	NEW	092
RAFTER mix LED surface	RA9014		160
RAFTER points LED trim recessed	RA2013	NEW	088
RAFTER points LED multitrack	RA1017	NEW	268
RAFTER points LED recessed	RA1013		094
RAFTER points LED section recessed	RA1613		094
RAFTER points LED section surface	RA1614		158
RAFTER points LED section suspended	RA1615		216
RAFTER points LED surface	RA1014		158
RAFTER points 54 LED suspended	RA1015		216
RAFTER points LED track	RA1016	NEW	268
RAFTER wall washer LED trim recessed	RA2213	NEW	090
REVEL dot LED 230V surface	RE1074		126
REVEL dot LED 230V suspended	RE1075		184
REVEL LED recessed	RE0013		076
REVEL LED surface	RE0014		126
REVEL LED suspended	RE0015		184
RING 111 230V recessed	37162		048
RING 111 QRLED recessed	RI0063		048
RING 111 QRLED trimless recessed	RI4063		048
RING 111 recessed	37151		048
RING 111 trimless 230V recessed	37163		048
RING 111 trimless recessed	37161		048
RING LED recessed	RG0013		076
RING next 50 LED recessed	RI6813	NEW	046

ROLL simple LED DALI track	RL1016	NEW	266
ROLL simple LED spot	RL1011	NEW	266
ROLL simple LED track	RL1016	NEW	266
ROTTO LED 230V spot	RT0071		244
ROTTO LED 230V track	RT0076		244
ROTTO spot	12991		244
ROTTO track	16219		244

S

SET RAW mini LED hermetic wall	SR1812		302 / 376
SET RAW mini LED recessed	SR1013		086
SET RAW mini LED surface	SR1014		156
SET RAW mini LED suspended	SR1015		214
SET RAW mini LED wall	SR1012		302
SET RAW mini move LED wall	SR2012	NEW	302
SET TRU mini LED multitrack	SR3017	NEW	272
SET TRU LED hermetic surface	ST0814		378
SET TRU LED hermetic suspended	ST0815		378
SET TRU LED hermetic wall	ST0812		378
SET TRU LED recessed	BC0022		098
SET TRU LED surface	BB0022		164
SET TRU LED suspended	BA0022		218
SET TRU LED wall	BD0022		332
SET TRU PRO mini LED multitrack	SR3017	NEW	272
SET TRU PRO LED recessed	BC0022		098
SET TRU PRO LED surface	BB0022		164
SET TRU PRO LED suspended	BB0022	NEW	218
SET TRU PRO up&down LED suspended	ST2015	NEW	218
SET TRU up&down LED suspended	ST2015		218
SET TRU up&down LED wall	ST2012		332
SIRCA LED recessed	SC0013	NEW	044
SLEEK 111x1 QRLED recessed	SL3063		072
SLEEK 111x1 QRLED wall	SL3062		324
SLEEK 111x1 recessed	30023		072
SLEEK 111x1 wall	26313		324
SLEEK 111x2 QRLED recessed	SL4063		072
SLEEK 111x2 QRLED wall	SL4062		324
SLEEK 111x2 recessed	30024		072
SLEEK 111x2 wall	26314		324
SLEEK distance 111x1 QRLED surface	SL3964		138
SLEEK distance 111x1 surface	46612		138
SLEEK distance 111x2 QRLED surface	SL4964		138
SLEEK distance 111x2 surface	46613		138
SLEEK distance 111x3 surface	46614		138
SLEEK distance 111x3 QRLED surface	SL5964		138
SLIMMER 17 LED hermetic surface	SM1814		374
SLIMMER 17 LED hermetic wall	SM1812		374
SLIMMER 30 LED hermetic surface	SM2814		374
SLIMMER 30 LED hermetic wall	SM2812		374
SMART PANEL GL oval LED wall	SP9712		330
SMART PANEL GL square LED wall	SP9212		330
SQUARES 111x1 QRLED recessed	SQ0163		064
SQUARES 111x1 QRLED trimless recessed	SQ4163		064
SQUARES 111x1 recessed	30511		066
SQUARES 111x1 trimless recessed	31811		066
SQUARES 111x2 QRLED recessed	SQ0263		064
SQUARES 111x2 recessed	30612		066
SQUARES 111x2 trimless recessed	31912		066

SQUARES 11x2 QRLED trimless recessed	SQ4263		064
SQUARES 50x1 230V recessed	36811		060
SQUARES 50x1 230V surface	45811		132
SQUARES 50x1 trimless 230V recessed	37011		060
SQUARES 50x2 230V recessed	36812		060
SQUARES 50x2 230V surface	45812		132
SQUARES 50x2 trimless 230V recessed	37012		060
SQUARES mini 111x1 QRLED surface	SQ1164		134
SQUARES mini 111x1 surface	40110		134
SQUARES mini 111x2 QRLED surface	SQ1264		134
SQUARES mini 111x2 surface	40111		134
SQUARES next 50x1 LED recessed	SX1813	NEW	058
SQUARES next 50x1 LED surface	SX1814	NEW	132
SQUARES next 50x1 LED trimless recessed	SX3813	NEW	058
SQUARES next 50x2 LED recessed	SX2813	NEW	058
SQUARES next 50x2 LED surface	SX2814	NEW	132
SQUARES next 50x2 LED trimless recessed	SX4813	NEW	058
SWING 12 LED trimless recessed	SW1013		054
SWING 12 trimless recessed	36700		054
SWING 24 LED trimless recessed	SW2013		054
SWING 24 trimless recessed	36703		054

systems

system MIXLINE LED recessed	R11013		406
system MIXLINE LED surface	R11014		408
system MIXLINE LED suspended	R11015		410
system RAW mini recessed	R10013		414
system SPIDER: KARI	K10075		392
system SPIDER: MAXI POINT round LED 230V spider wall	M10172	NEW	392
system SPIDER: MAXI POINT square LED 230V spider wall	M10272	NEW	392
system SPIDER: MODERN GLASS SPIDER suspended	M11015		392
system SPIDER: PET next mini LED SPIDER suspended	P11815	NEW	392
system SPIDER: PET next LED SPIDER suspended	P10815	NEW	392
system TRU LED	T10014		416

T

THIN TUBE asymmetry LED suspended	TT0415		222
THIN TUBE central LED suspended	TH0315		222
THIN TUBE LED hermetic wall	TT0812		382
THIN TUBE LED wall	TT0012		342
TUBA 111 11 230V surface	TU9064		122
TUBA 111 230V suspended	59641		192
TUBA 111 230V track	16243		258
TUBA 111 QRLED 230V surface	TU0164		120
TUBA 111 QRLED 230V suspended	TU0165		192
TUBA 111 QRLED 230V track	TU0166		258
TUBA 111 QRLED surface	TU0064		120
TUBA 111 QRLED suspended	TU0065		192
TUBA 111 QRLED track	TU0066		258
TUBA 111 11 surface	TU9054		122
TUBA 111 suspended	59631		192
TUBA 111 track	16233		258
TUBA 50 230V surface	45921		118
TUBA distance 111x1 230V surface	45602		122
TUBA distance 111x1 QRLED 230V surface	TU3264		120
TUBA distance 111x1 QRLED surface	TU3964		120

TUBA distance 111x1 surface	45603		122
TUBA distance 111x2 230V surface	45632		122
TUBA distance 111x2 QRLED 230V surface	TU4264		120
TUBA distance 111x2 QRLED surface	TU4964		120
TUBA distance 111x2 surface	45630		122
TUBA distance 50x1 230V surface	45941		118
TUBA distance 50x2 230V surface	45935		118
TUBA next 50 LED surface	TU3814	NEW	118
TUBA wall	20102		320

All dimensions and technical data in catalogues are provided for guidance purposes only. Actual data may differ slightly due to the production process. Technical information contained within Aquaform's website, data sheets or mounting instructions shall prevail over the information contained in catalogues. Aquaform Inc. reserves the right to change the presented materials and product specifications without prior notice.

Aquaform Inc. takes no responsibility for any possible misprints. All photos, icons and images are copyright protected. Images are illustrative presentations of products and colours. Due to the production process RAL colour of white track and adapter differs a few tones from standard white finish of AQForm luminaires.

Information contained in the catalogue shall not constitute an offer, also within the meaning of art. 66 § 1 of Polish Civil Code.

© 2020 AQUAFORM Inc. sp. z o.o.
All rights reserved.

AQUAFORM Inc. sp. z o.o.
ul. Przemysłowa 12-14, 32-070 Czernichów, Poland | + 48 12 270 21 22 | info@aqform.com

Podane w katalogach wymiary oraz informacje techniczne mają jedynie charakter informacyjny. Rzeczywiste dane mogą się nieznacznie różnić ze względu na proces produkcyjny. Informacje techniczne zawarte na stronie www, w kartach katalogowych oraz w instrukcjach montażu mają pierwszeństwo przed informacjami z katalogów. Aquaform Inc. zastrzega sobie prawo do zmiany przedstawianych materiałów i parametrów technicznych produktów bez wcześniejszego powiadomienia.

Aquaform Inc. nie ponosi odpowiedzialności za możliwe błędy w druku. Zdjęcia są chronione prawnie. Na zdjęciach pokazane jest poglądowe przedstawienie produktów oraz kolorów. Ze względu na proces produkcyjny kolor RAL białych szynoprzewodów oraz adapterów różni się o kilka tonów od standardowego białego wykończenia opraw AQForm.

Informacje zawarte w katalogu nie stanowią oferty handlowej, w tym w rozumieniu art. 66 §1 Kodeksu Cywilnego.

© 2020 AQUAFORM Inc. sp. z o.o.
Wszelkie prawa zastrzeżone.



Light rarely ends.

PART OF
DELTALIGHT
Group

How to configure
catalogue number?
Check inside.

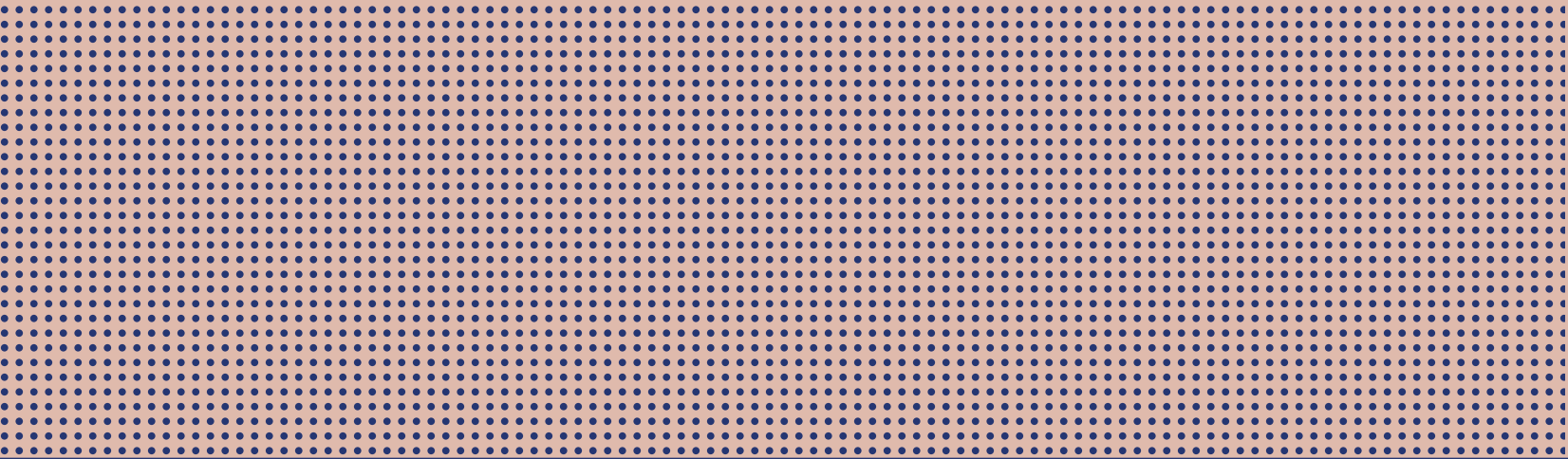

info@aqform.com
www.aqform.com