



**Acustio**

Acoustic furniture. For a better work life.

# STALACTITE





**about**



We are Acustio. We design and manufacture acoustic furniture solutions for the modern office.

Our sound-absorbing panels are work-friendly by design. Just imagine how comfortable work will become with our desk dividers, wall panels, free-standing room dividers and phone booths, to name just a few.

Acustio's flexible and functional solutions mean a shared office space can retain intimacy and a productive peace and quiet. It becomes surprisingly free from unwanted distractions, such as conversations, phones or noisy printers.

Our values are simple. All Acustio products are handmade with love and crafted to perfection, and attention to detail is what we do take pride in.

EDGE FINISHING

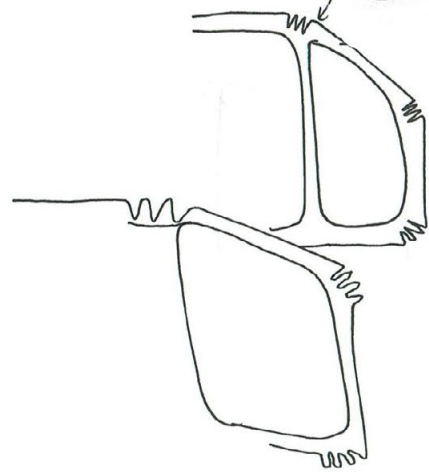

MARGIN PROPORTIONS

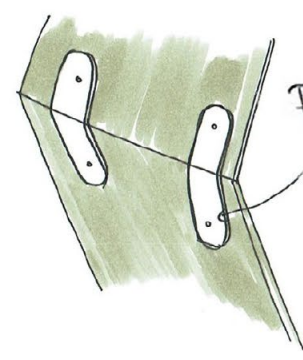
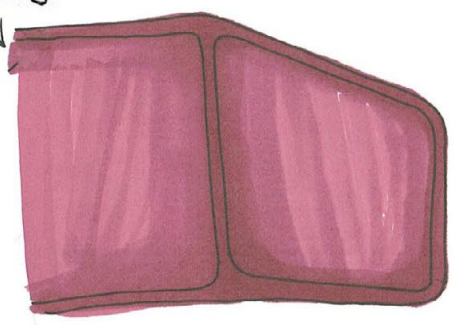
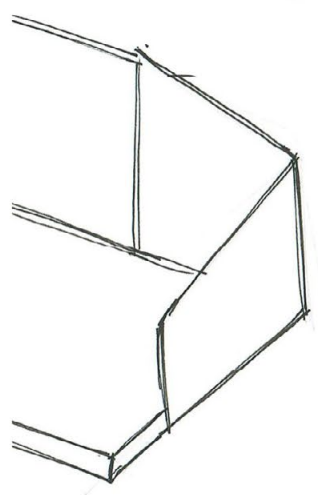

PRESS STUDS

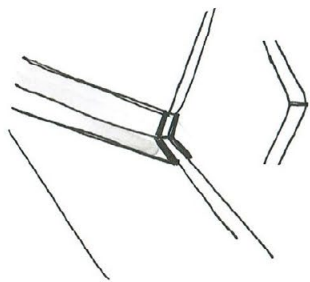

HOLDING

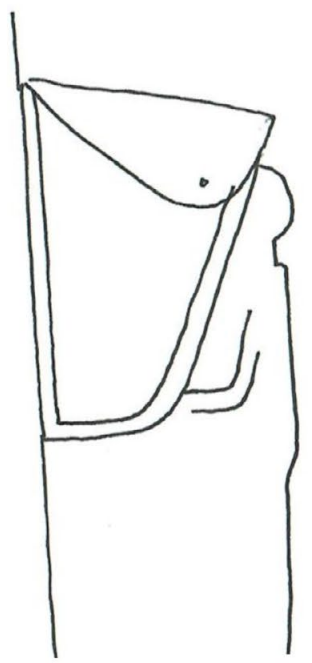
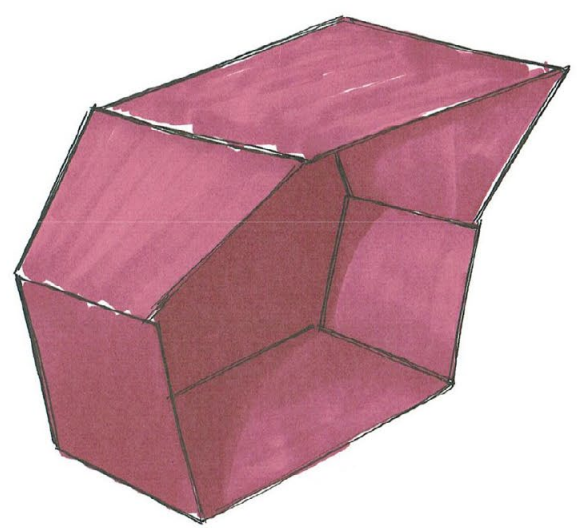

SAME FORM

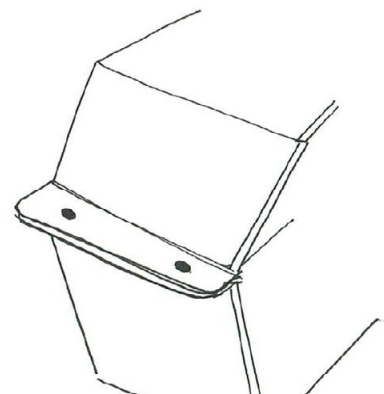
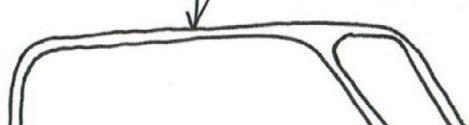



Functional and flexible, it has been designed to look up to. Stalactite adds a new definition to hanging around the office, one that makes managers sigh with delight at the peace and quiet of their noise-free interiors.

Stalactites can be mounted to the wall using a wooden lath or suction cups (best for glass surfaces). They can have different colours on the sides, and each can be turned back to front instantly. Now it is possible to redesign the room or create a different mood in the workplace in no time.



Designed by  
**Nikodem Szpunar**  
Studio Szpunar

# STALACTITE

---

Up to three separate pieces can be attached to the wooden lath, and then slid along the length. A swift and simple operation, the Stalactite is mounted using the slidable metal clamp on the back, covered with a varnished wooden dowel on the front.

For glass surfaces, users opt to take advantage of the suction cups. Flat on one side (with a 3mm HDF board inside), this version is perfect for see-through walls. Think a grey interior for the conference room, and an orange exterior for the reception! Symmetrical in shape, a Stalactite can be hung one on each side of a glass wall for an even better acoustic experience.





Handwritten note on a small white card, pinned to the leftmost grey board. The text is illegible due to the image resolution.



# COLOURS

---

## CATEGORY A

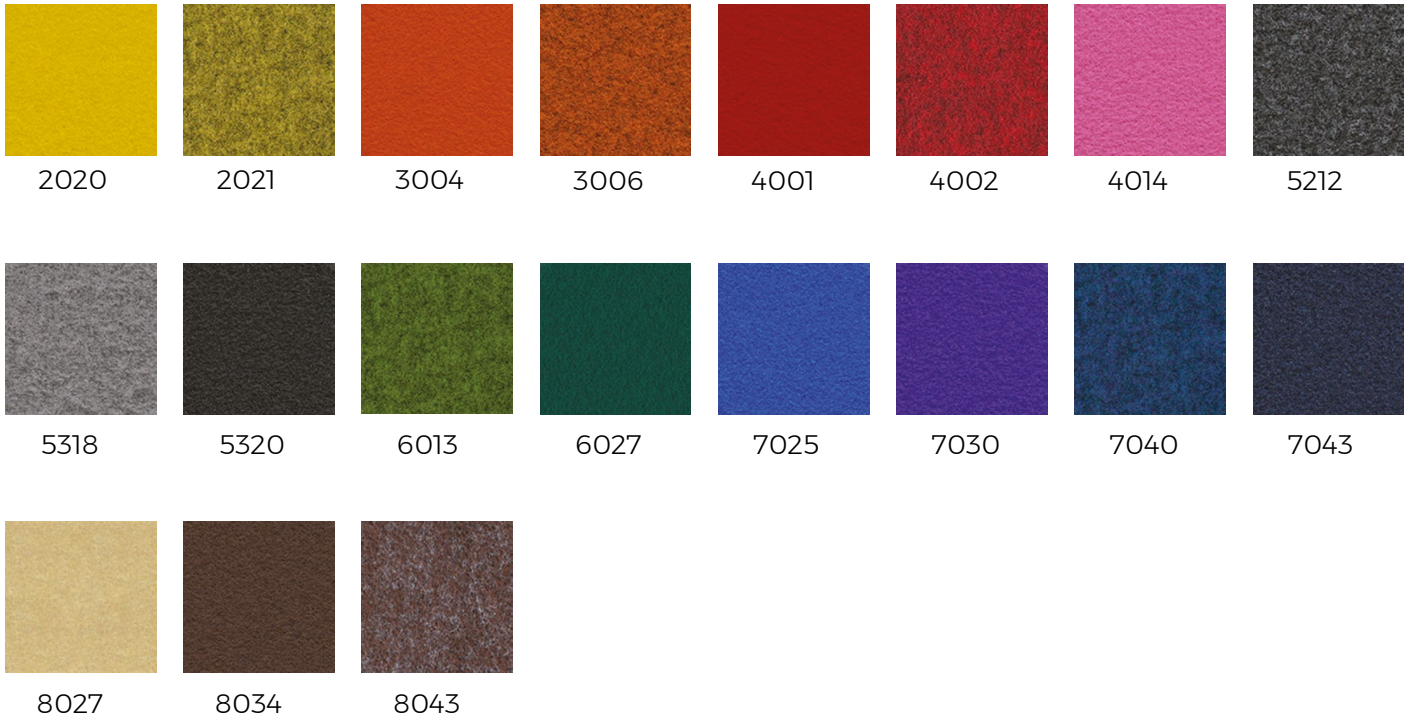

## CATEGORY B







All our projects are completed in cooperation  
with top-tier national and global distributors.

Architects, designers and commercial real estate developers,  
please contact us at [marketing@acustio.com](mailto:marketing@acustio.com)

Our global sales and support network is at your disposal  
and will gladly provide further information and inspiration.