

# HEX

---

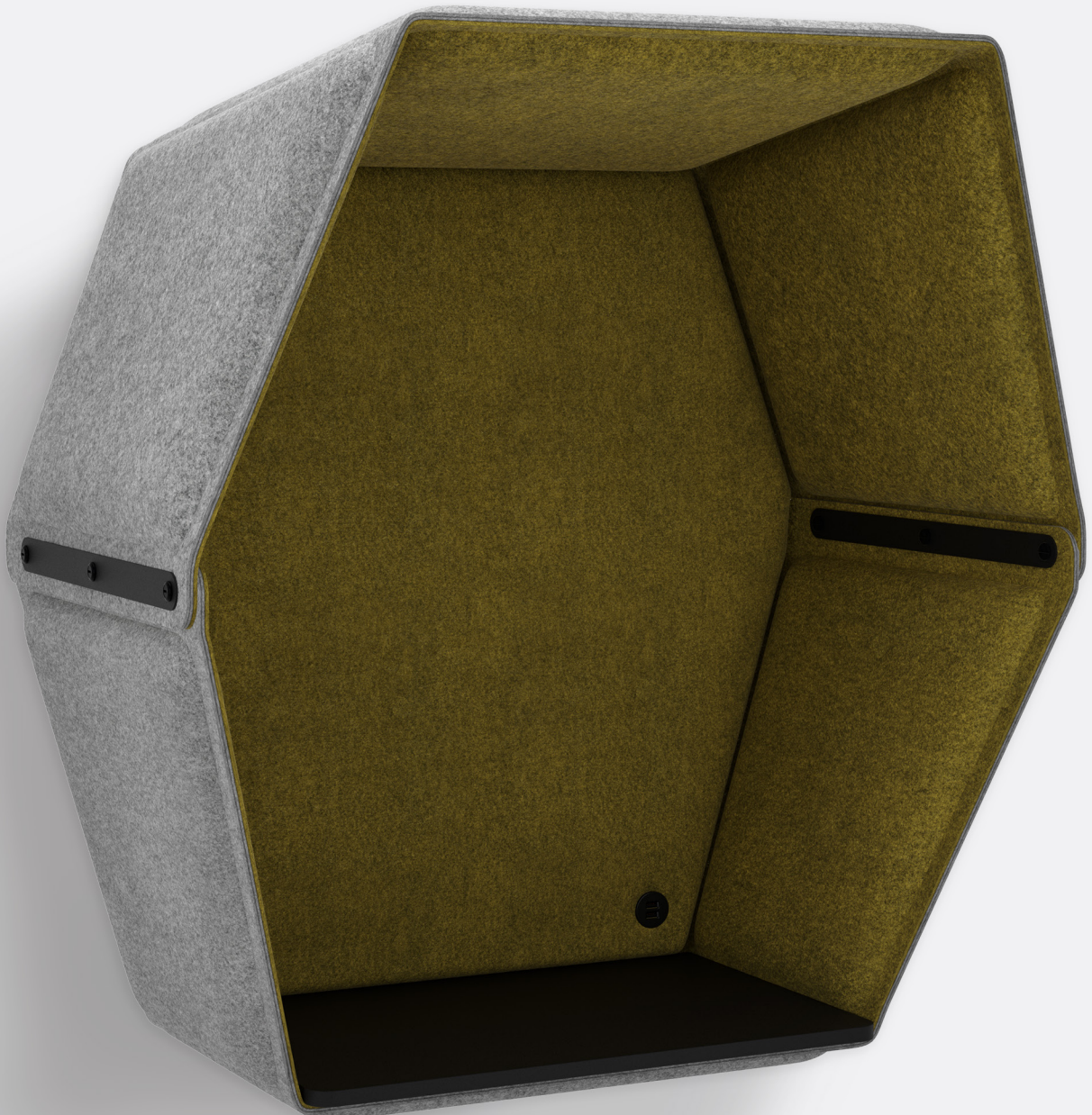



**about**

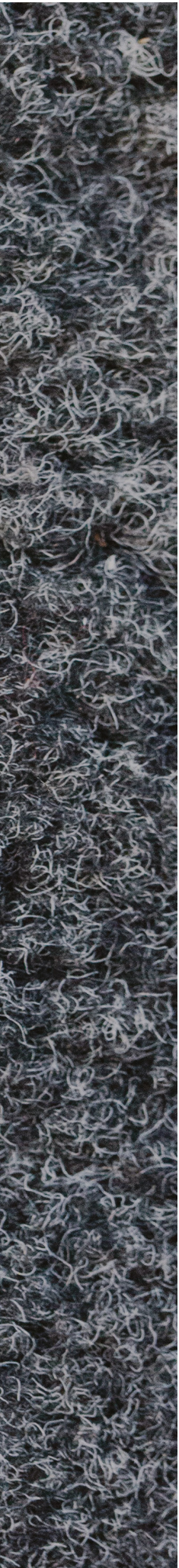

We are Acustio. We design and manufacture acoustic furniture solutions for the modern office.

Our sound-absorbing panels are work-friendly by design. Just imagine how comfortable work will become with our desk dividers, wall panels, free-standing room dividers and phone booths, to name just a few.

Acustio's flexible and functional solutions mean a shared office space can retain intimacy and a productive peace and quiet. It becomes surprisingly free from unwanted distractions, such as conversations, phones or noisy printers.

Our values are simple. All Acustio products are handmade with love and crafted to perfection, and attention to detail is what we do take pride in.

EDGE FINISHING

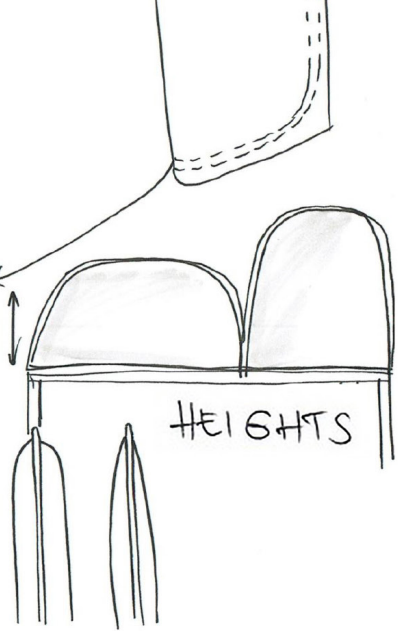
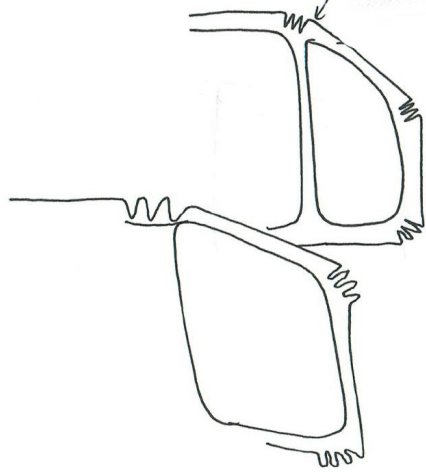

HEIGHTS

MARGIN PROPORTIONS

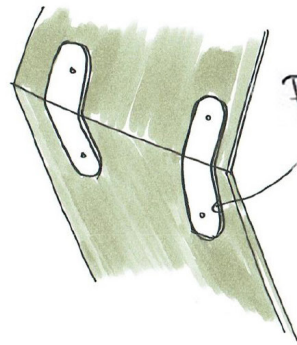
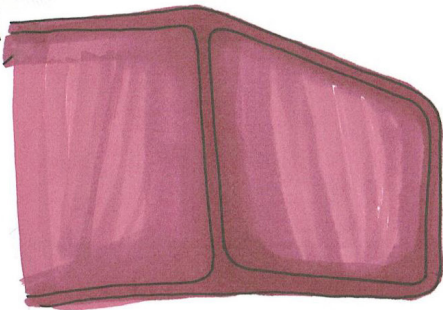

PRESS STUDS

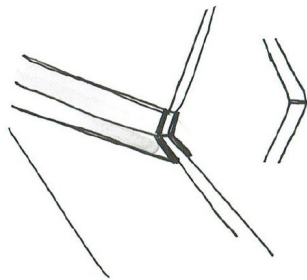
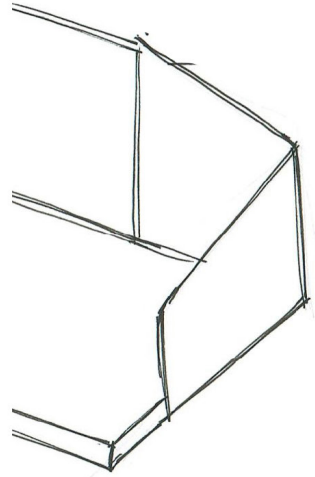

HOLDING

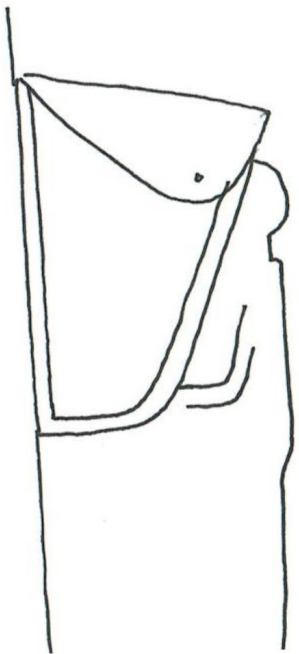
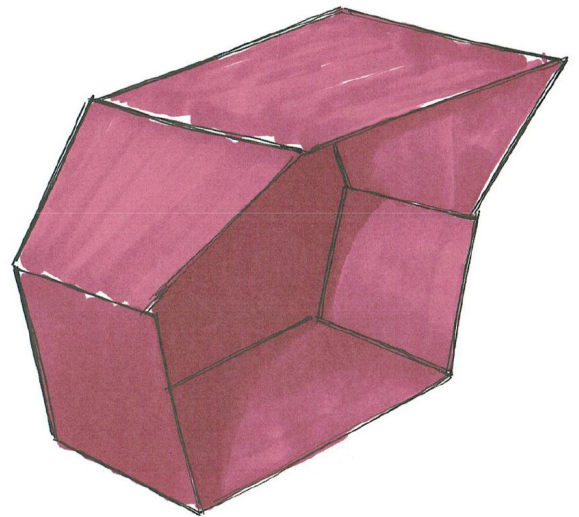

SAME FORM

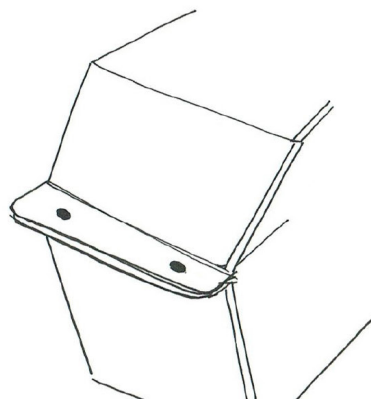



When you listen to the needs of your clients, you design Hex - an office furniture solution created to make everybody's work a more effective and pleasurable experience. The phone booth helps focus on your call rather than the outside noise. It is also a discrete companion, making sure the conversation is not a distraction to the colleagues outside.

Hex has a calling, and it is to make your user's calling as discrete an experience for them as it should be for everyone else in the room. With a number of distinctive features, our sound-absorbing telephone booths can be hung on the walls virtually everywhere.



Designed by  
**Nikodem Szpunar**  
Studio Szpunar

# HEX

---

Discover the joy of being able to make a more discrete phone call without leaving the office and engaging your colleagues in your own conversation. Available in a variety of colour combinations, the Hex telephone booth is covered with our signature superb-quality felt. The slim version is 85 cm across and 95 cm high.

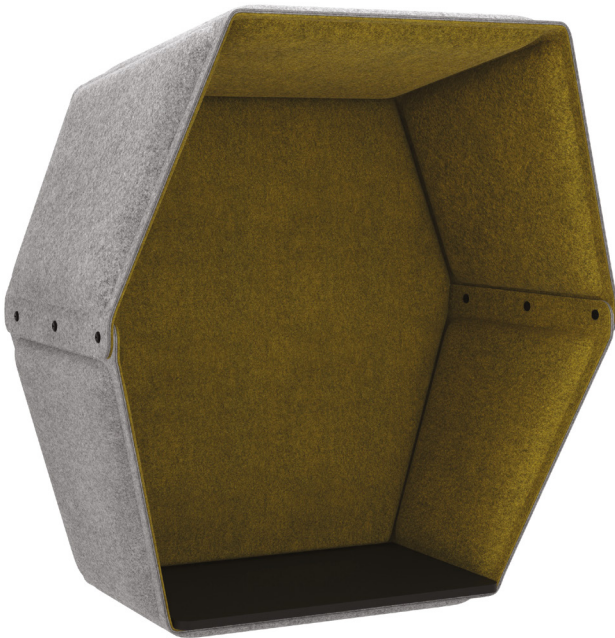

Fabrics and colours? We know the subject inside out! Hex guarantees the freedom to choose different colours for both the inside and the outside of the booth. What's more, our clients are amazed by the rich experience of the Camira Blazer upholstery, a classic pure new wool fabric with a felted finish.



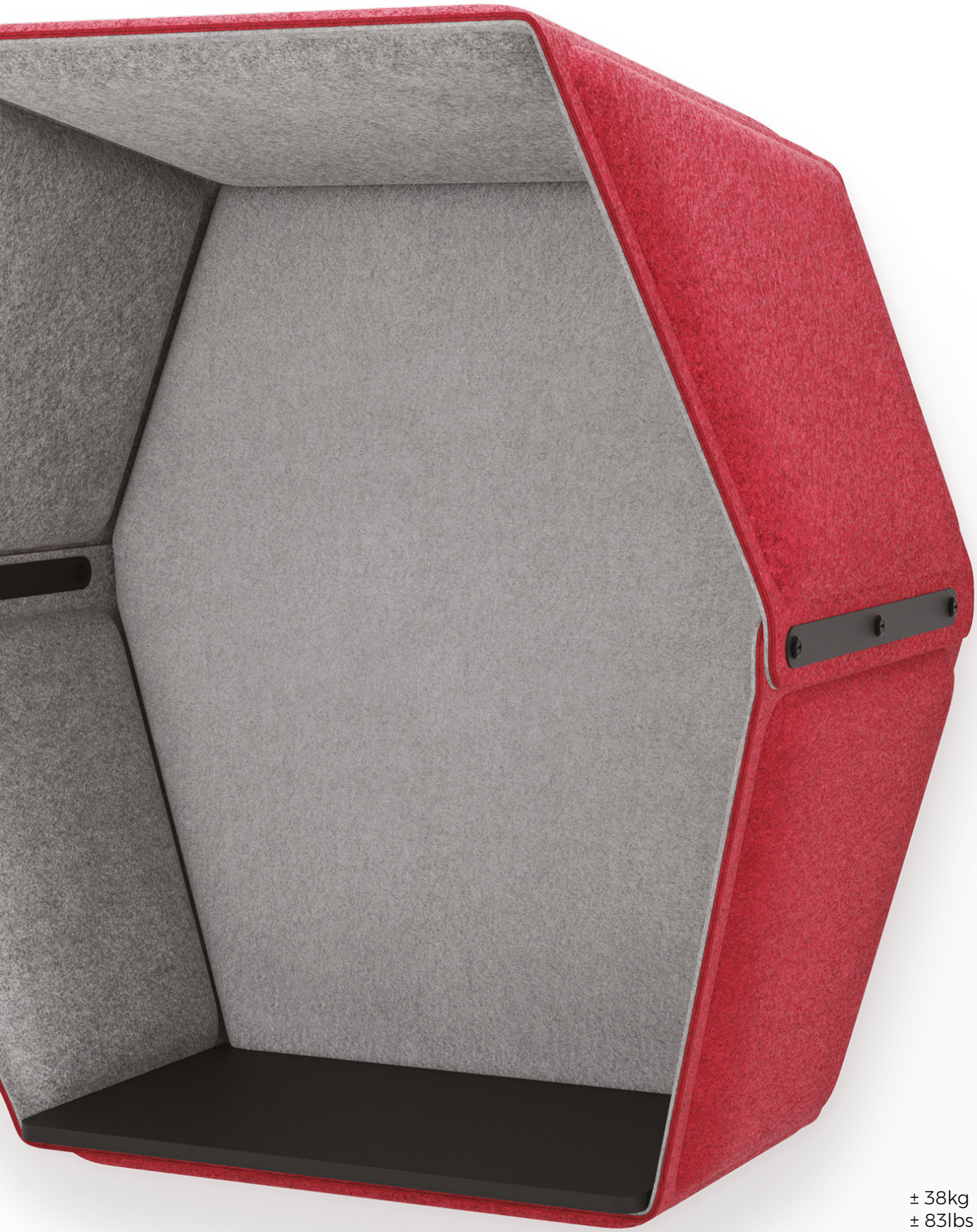

± 38kg  
± 83lbs



L 57 cm

W 85 cm

H 95cm



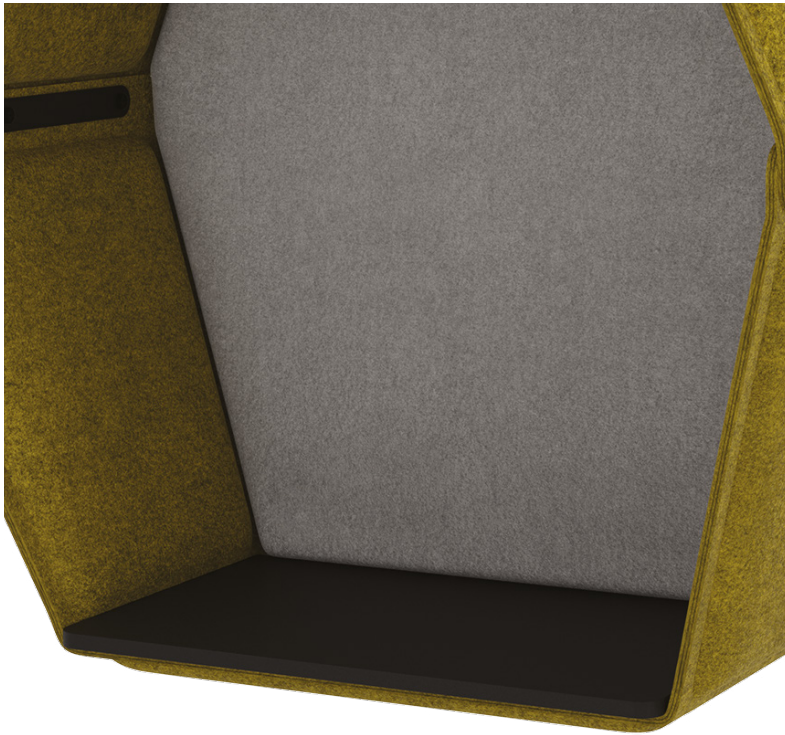

A sturdy, water-resistant surface, the MDF desktop offers ample space for a smaller laptop, the smartphone, a tablet or a notebook. Or a cup of coffee. Or even a rolodex, for the traditional among us.

### Table dimension



L 33 cm

W 55 cm

Hex is all about staying connected. The double USB port allows for simultaneous charging of two mobile devices while making the call.







Perfection is in the details - and the details make assembling the booth a very simple procedure. Hex's design means the solid structure can be held together by using either a metal plate with pins, or the pins alone.

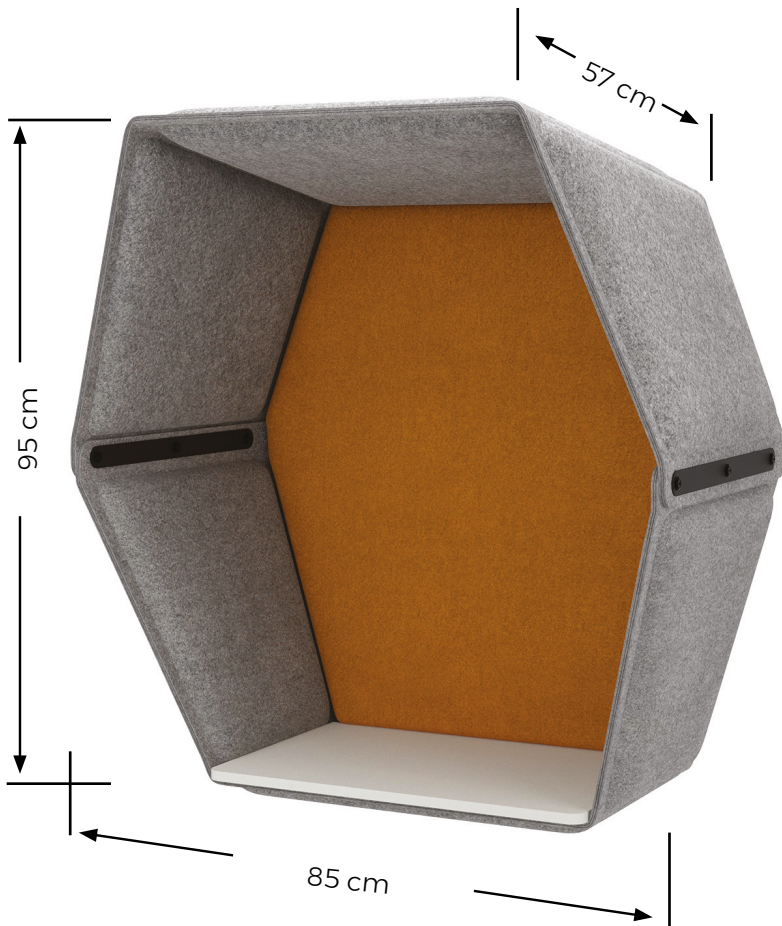

Combining exquisite design and stunning functionality, Hex's job is to make everyone's daily work even more comfortable and efficient. The phone booths can be hung at a variety of heights - a fact both horse jockeys and basketball players would gladly appreciate.

Hex is easy to mount thanks to our attaching solution that includes a level at the back of the booth for quick alignment. Only one person is required and the job can be completed in no time.

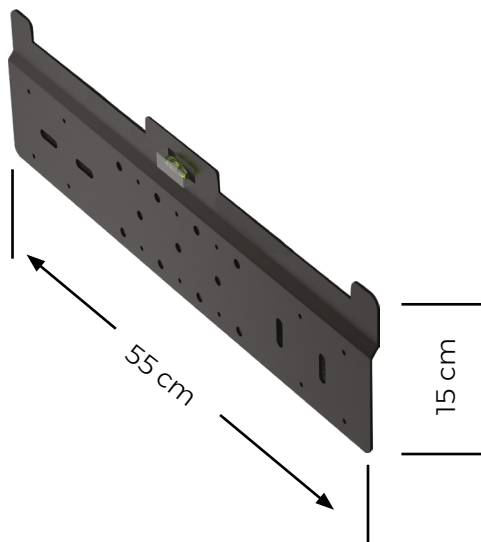

# COLOURS

## CATEGORY A

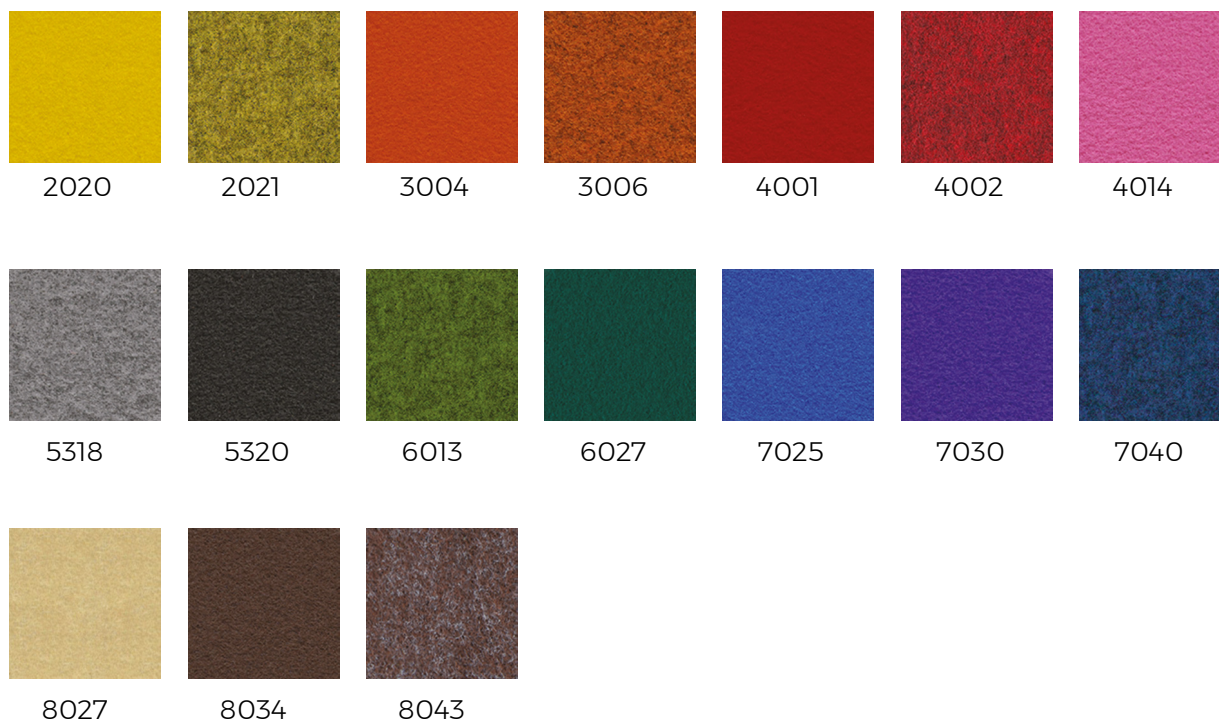

## CATEGORY E

All 74 colours of [Camira Blazer](#)

## METAL ELEMENTS



## TABLE COLOUR



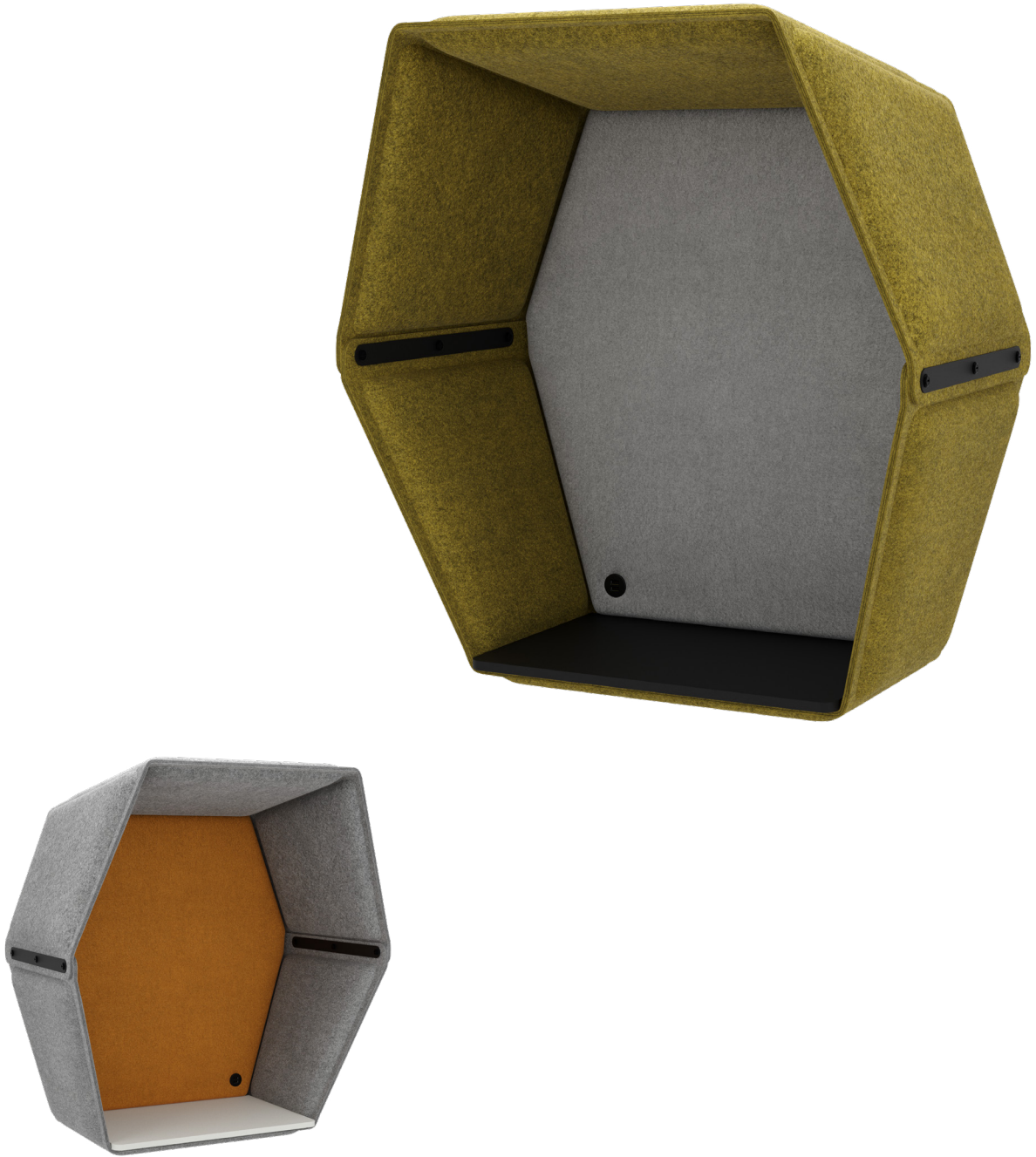

All our projects are completed in cooperation with top-tier national and global distributors.

Architects, designers and commercial real estate developers, please contact us at [marketing@acustio.com](mailto:marketing@acustio.com)

Our global sales and support network is at your disposal and will gladly provide further information and inspiration.