





about



We are Acustio. We design and manufacture acoustic furniture solutions for the modern office.

Our sound-absorbing panels are work-friendly by design. Just imagine how comfortable work will become with our desk dividers, wall panels, free-standing room dividers and phone booths, to name just a few.

Acustio's flexible and functional solutions mean a shared office space can retain intimacy and a productive peace and quiet. It becomes surprisingly free from unwanted distractions, such as conversations, phones or noisy printers.

Our values are simple. All Acustio products are handmade with love and crafted to perfection, and attention to detail is what we do take pride in.

JASPER





Jasper simplifies the process of making things simple. It works in two directions: the standalone, vertical room dividers make cozy spaces out of open spaces. The horizontal, desktop partitions make the smaller spaces even cozier. The hanging panels work in the background. They make all spaces cozy.

It is a family of sound absorbing furniture that will make effective work a more inspiring, pleasurable experience. Covered in high-quality seamless upholstery, they evoke a feeling of intimacy and coziness. An easier focus and a clearer mind are now literally at at one's fingertips.

JASPER ROOM DIVIDERS

Covered in high-quality seamless upholstery, the free-standing room dividers inspire a feeling of intimacy and coziness. They are by design made to add a sense of individual space that makes it easier to focus on the work ahead. Toned-down and refreshingly quiet for a surprisingly effective working experience, they make your day, every business day.



JASPER DESKTOP

Our dedicated adapters work with desks from the world's leading manufacturers. We also design universal solutions for a number of branded and non-branded desks.

Pictures, notes and small objects can be pinned to the surface of Acustio's behind-the-desk panels. There is an amazing choice of sizes, colours and types of fabric for the high-quality seamless upholstery.



JASPER MOBILITY

The mobile desktop partitions can be sat on the surface with no need for screws, allowing for complete freedom and flexibility. They are a perfect solution to meet the needs of smaller project groups, privacy-wise. Dedicated working space can be arranged instantly!

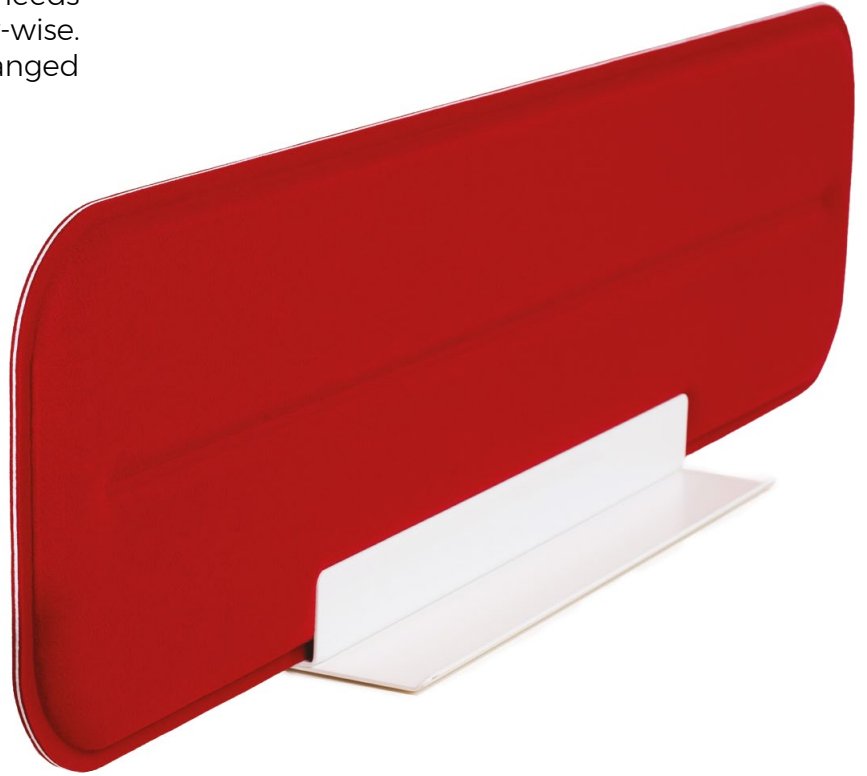

JASPER WALL

Acustio's Jasper wall panels work hard to reduce the echo in larger spaces, such as conference rooms, vast open-space offices or halls. They can be easily attached to the surface using a strong and reliable, yet removable mounting system. Cubic metres of warmth and coziness are guaranteed in any space.



JASPER CEILING

The Jasper family includes ceiling panels which can be fixed at various heights, and the choice of beautiful colours is astonishing. Available in three shapes: round, square, and rectangular, the panels will add a touch of art to a cozy, modern office.



ANALYTICS

Frequency f [Hz]	T1 [S]	T2 [S]	α_S	α_p
100	6.52	4.60	0.21	0.35
125	5.58	3.65	0.30	
160	5.06	2.91	0.47	
200	5.16	2.83	0.51	0.65
250	5.24	2.61	0.62	
315	5.56	2.40	0.76	
400	6.18	2.42	0.81	0.90
500	6.68	2.38	0.87	
630	6.42	2.20	0.96	
800	6.17	2.08	1.02	1.00
1000	6.17	2.05	1.04	
1250	6.06	2.02	1.06	
1600	5.84	2.03	1.03	1.00
2000	5.53	1.97	1.05	
2500	4.97	1.82	1.12	
3150	4.26	1.72	1.11	1.00
4000	3.56	1.59	1.12	
5000	2.86	1.42	1.14	

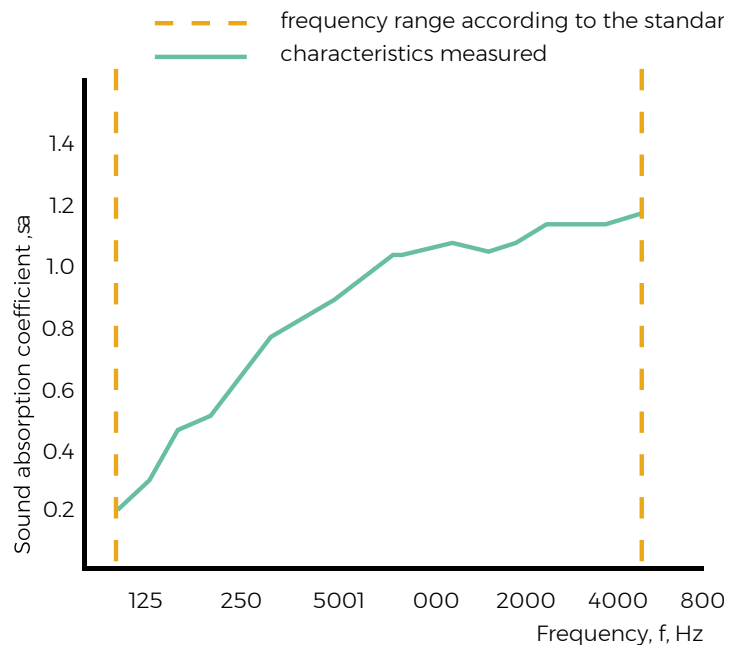

PN-EN ISO 11654:1999

$\alpha_w = 0.90$

Absorption Class **A**

MIDDLE LAYER COLOUR

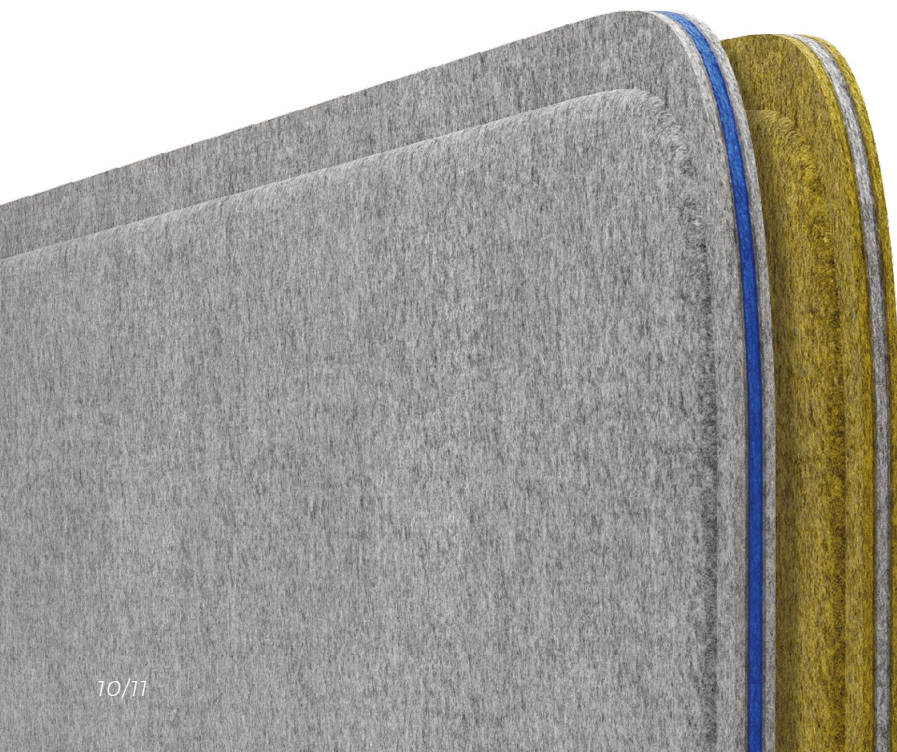

Jasper lets you choose the colour of each of the three layers of its upholstery.

And thanks to the Acustio's signature solution, now even the hue of the inside layer can be selected. A myriad combinations can be achieved that will perfectly reflect the Client's branding and the emotions that it embodies.

COLOURS

CATEGORY A

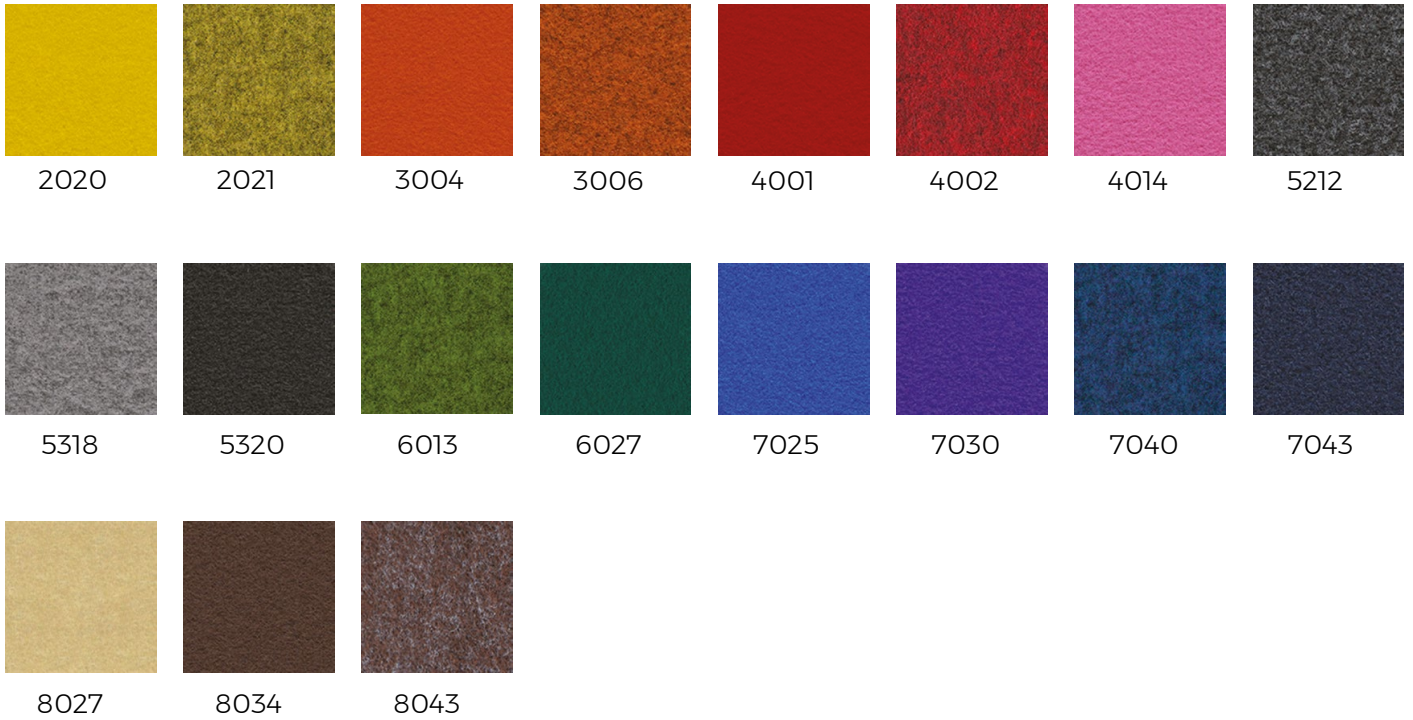

CATEGORY B



ROCKS





THE PANEL.

Endlessly bindable and flexible beyond reason, the Rocks panel stands firmly on its Boomerang feet. It shares Acustio's Heaven Booth philosophy so that any number of panels can be connected for unlimited comfort.

Designed in two heights (130 and 160 cm), the panel is the perfect ingredient of Rocks Wall, Rocks Desk (available in four different variants), the Cave (additional privacy within the office), and Rocks Sofa. Distinctively original and compellingly minimalist, they help create meeting spaces for smaller teams to sit down in comfort and talk in privacy.

ROCKS WALL

A flexible room divider, Rocks Wall can be shaped in a variety of ways - a circle, for example - for a deeper peace and quiet both inside and outside the enclosure. More focus and creativity make work sound perfect.



ROCKS CAVE

The high walls make it an island that perfectly fits one or two persons with a sense of necessary privacy. It is an on-demand solution that guarantees additional comfort and relaxation.

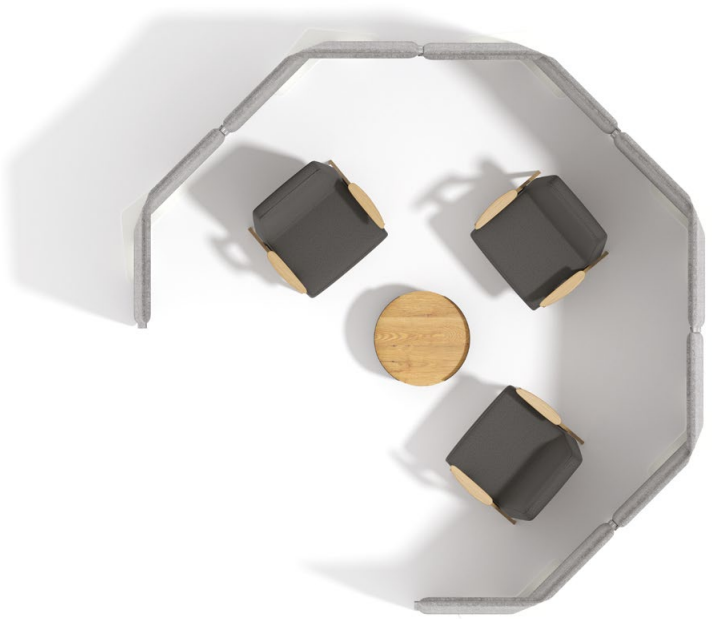

ROCKS DESK

Simple and functional, Rocks Desk is available in four different options - standing or sitting, the walls either converging or diverging. A revolutionary concept that sits well with everyone around the office.



STANDING

SITTING



DESKTOP SIZES:

63x118,5x105h

55,5x134x105h

58x128x75h

60x124,5x75h

MAXIMUM FUNCTIONALITY

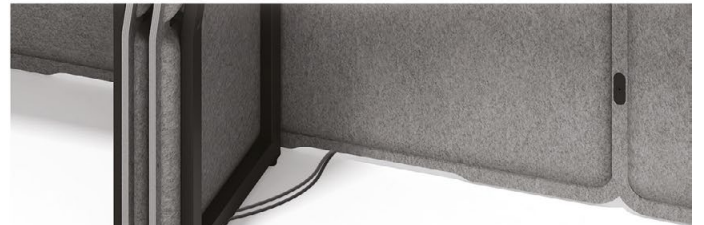
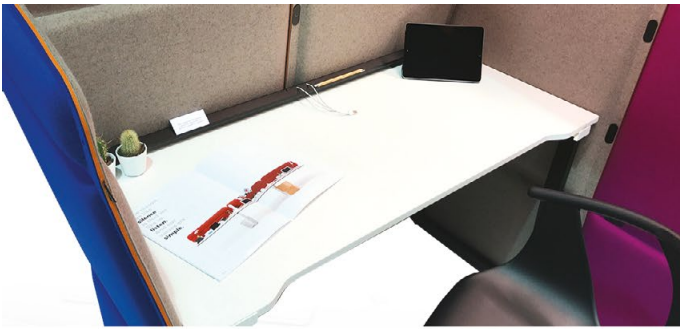

FELT COLOUR



5318

METAL PARTS



black

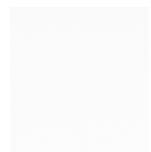

white

LEAVES





A family of beautifully designed panels, they are the only leaf-shaped acoustic products on the market. Leaves look great and work perfectly on regular and glass walls, ceilings, desks and floors.

The panels can be embossed on one or both sides and the choice of synthetic or natural wool felts is amazing by design.

LEAVES DESKTOP

The office is bound to feel greener with Acustio's leaf shapes, regardless of the felt colour chosen! The screens can be embossed on one or both sides, and user experience is second to none with a choice of sizes and a myriad colours to select from.

Our behind-the-desk privacy screens feature full-size and half-size versions that meet the needs of every office. And with Acustio's wide range of adapters, the panels can be mounted easily on desks from the world's leading manufacturers.

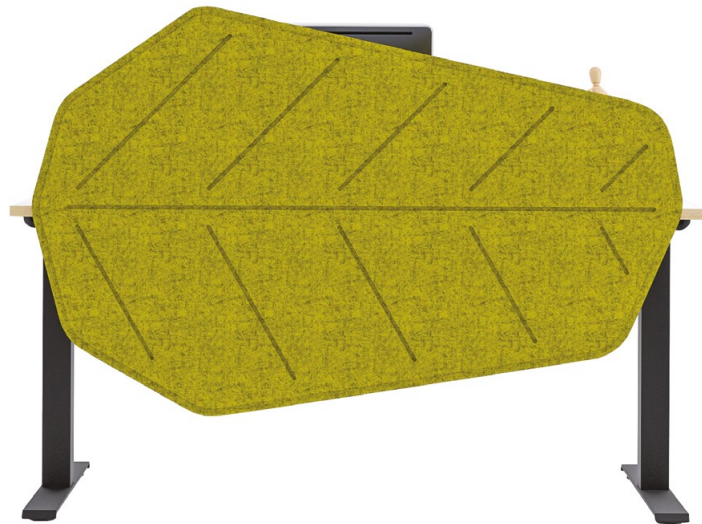

LEAVES ROOM DIVIDERS

Friendly and cosy by design, Leaves grow on users in all types of interiors. The floor is always theirs, the shape adds an air of light-hearted coziness, and the sound absorption is unheard of.

With three sizes in two different shapes, the room dividers stand for design and functionality. The three types of foot mount include one small leaf, one medium or large leaf, and a combination of two medium or large leaves alongside one small leaf.



LEAVES WALL

Behind the panel is where the magic happens - it is surprisingly easy to hang at any angle using the pre-mounted clips. And when attached to a transparent wall with suction cups, both sides of the leaf will be fully visible - imagine a greyish reception area on one side, and a vibrant yellow conference room on the other!

Should the architect choose to attach the panel to the ceiling - for an even greater acoustic effectiveness - a version is available with a wider, 3 cm edge.

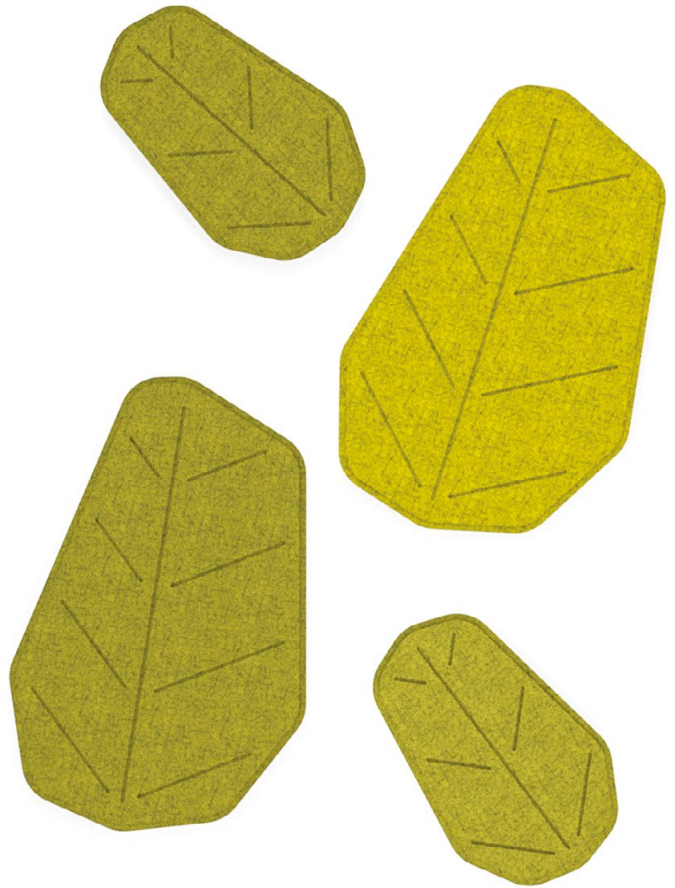

MIDDLE LAYER COLOUR

Leaves lets you choose the colour of each of the three layers of its upholstery.

And thanks to the Acustio's signature solution, now even the hue of the inside layer can be selected. A myriad combinations can be achieved that will perfectly reflect the Client's branding and the emotions that it embodies.

COLOURS

CATEGORY A



2020



2021



3004



3006



4001

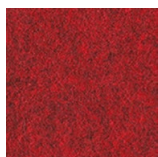

4002



4014

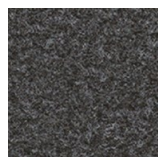

5212



5318

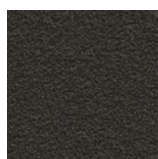

5320



6013



6027

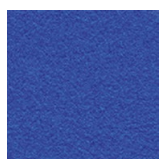

7025

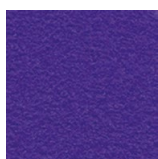

7030

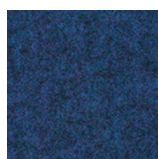

7040

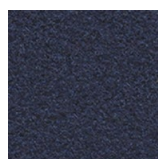

7043

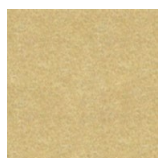

8027

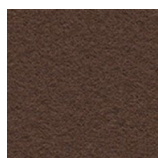

8034

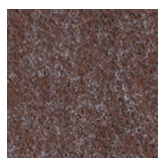

8043

HEX

Discover the joy of being able to make a more discrete phone call without leaving the office and engaging your colleagues in your own conversation. Available in a variety of colour combinations, the Hex telephone booth is covered with our signature superb-quality felt. The slim version is 85 cm across and 95 cm high.

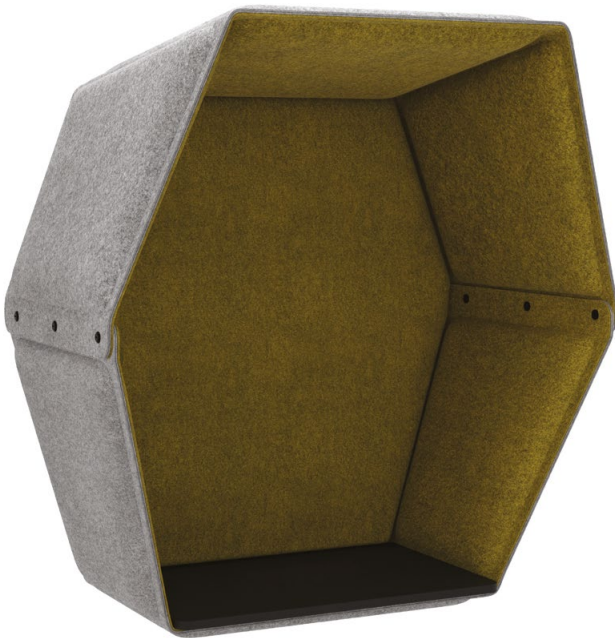

Fabrics and colours? We know the subject inside out! Hex guarantees the freedom to choose different colours for both the inside and the outside of the booth. What's more, our clients are amazed by the rich experience of the Camira Blazer upholstery, a classic pure new wool fabric with a felted finish.





± 38kg
± 83lbs



L 57 cm

W 85 cm

H 95cm



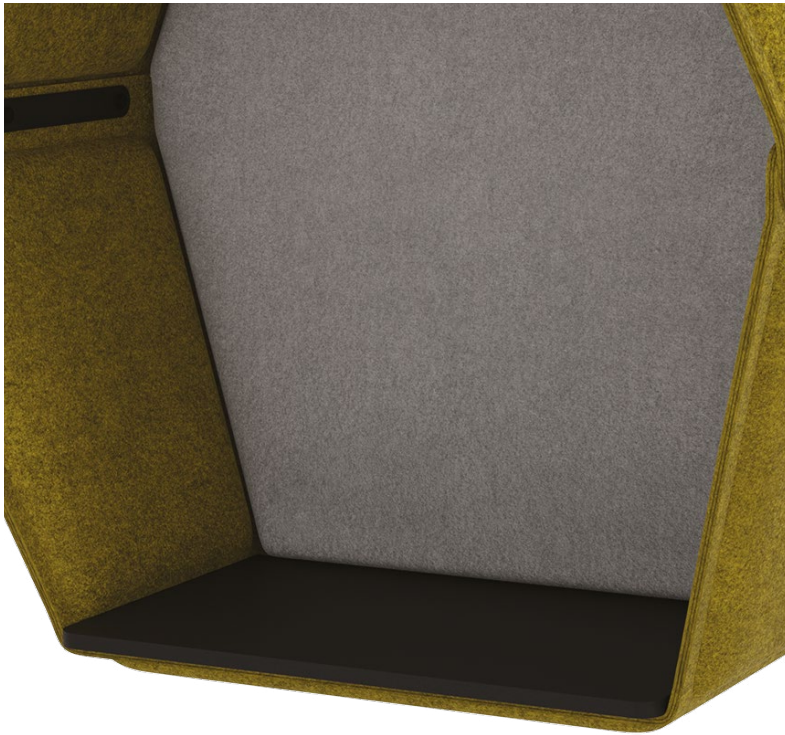

A sturdy, water-resistant surface, the MDF desktop offers ample space for a smaller laptop, the smartphone, a tablet or a notebook. Or a cup of coffee. Or even a rolodex, for the traditional among us.

Table dimension





L 33 cm

W 55 cm

Hex is all about staying connected. The double USB port allows for simultaneous charging of two mobile devices while making the call.

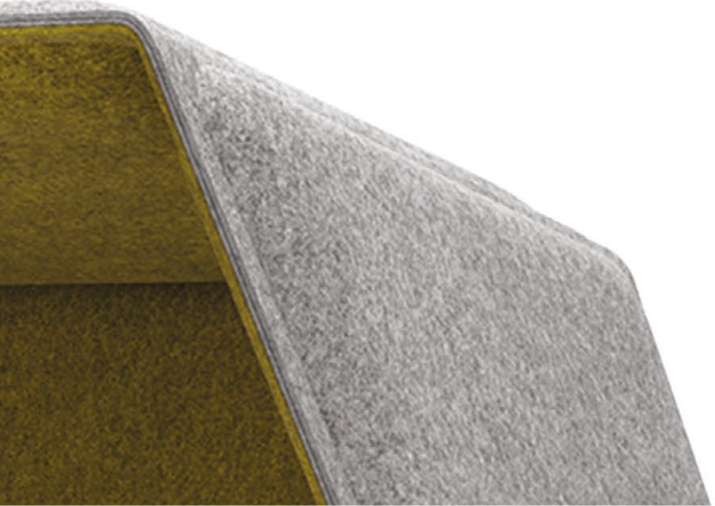
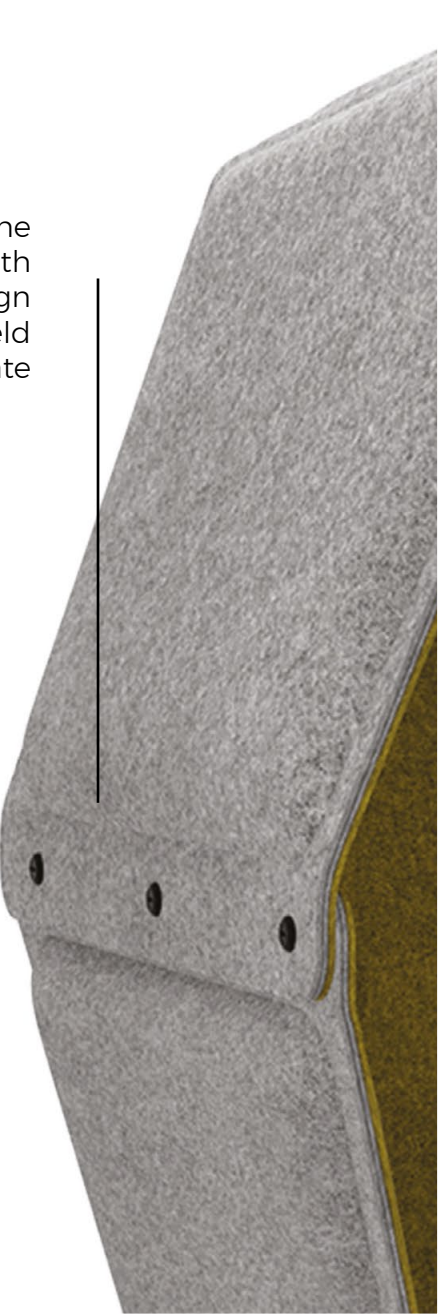
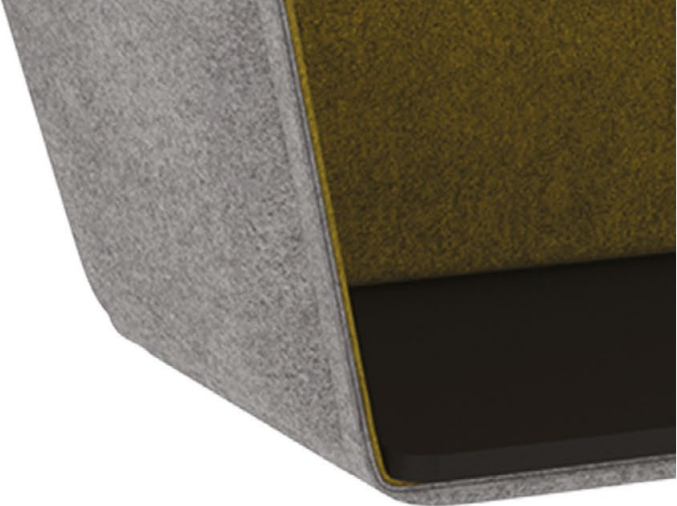



Perfection is in the details - and the details make assembling the booth a very simple procedure. Hex's design means the solid structure can be held together by using either a metal plate with pins, or the pins alone.

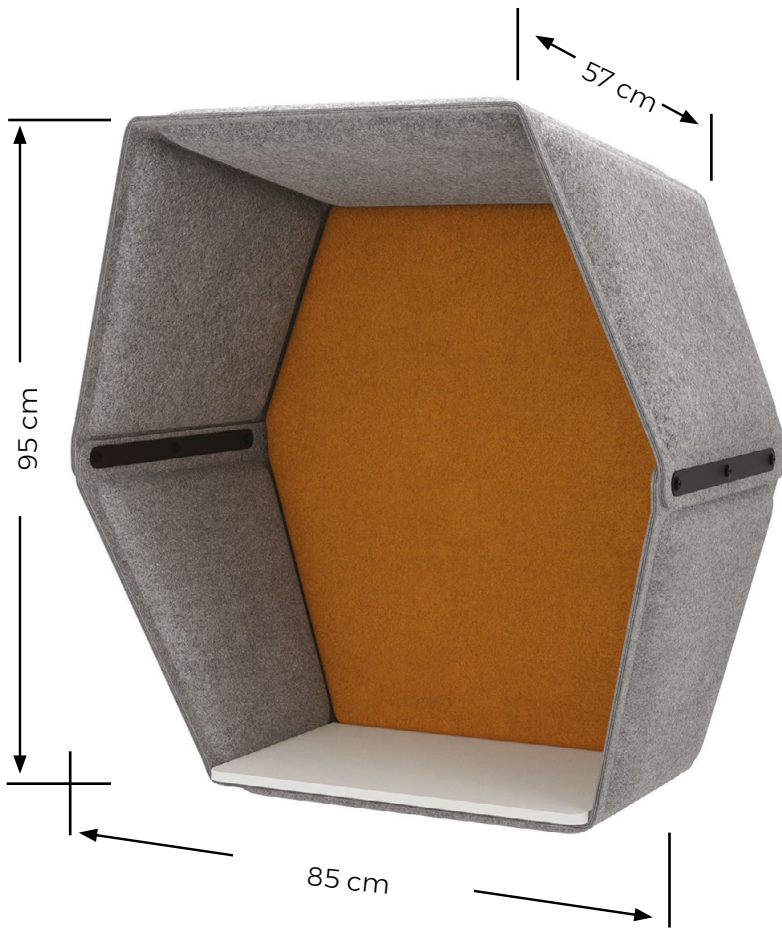

Combining exquisite design and stunning functionality, Hex's job is to make everyone's daily work even more comfortable and efficient. The phone booths can be hung at a variety of heights - a fact both horse jockeys and basketball players would gladly appreciate.

Hex is easy to mount thanks to our attaching solution that includes a level at the back of the booth for quick alignment. Only one person is required and the job can be completed in no time.

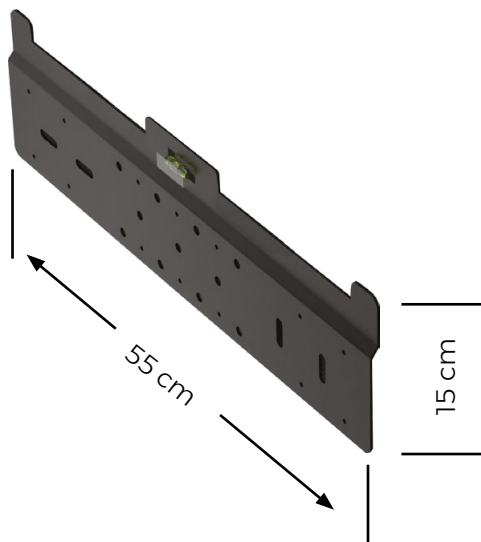

COLOURS

CATEGORY A

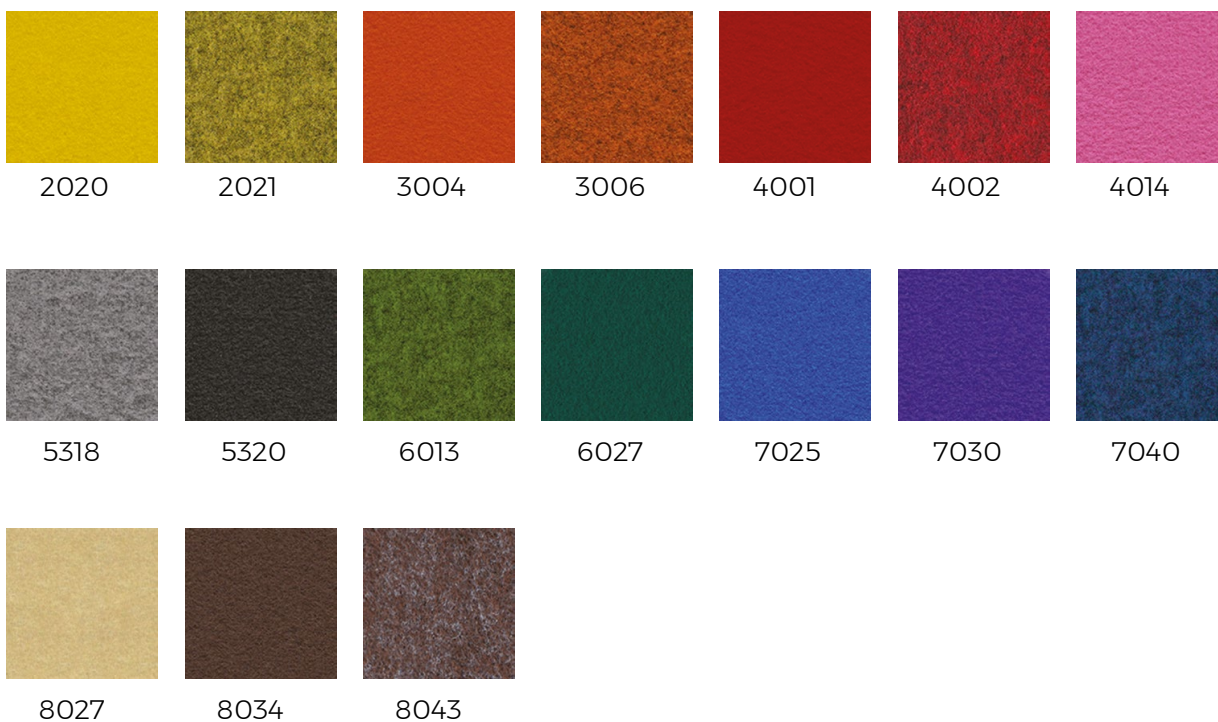

CATEGORY E

All 74 colours of [Camira Blazer](#)

METAL ELEMENTS



TABLE COLOUR



STALACTITE

Stalactite panels may be mounted in single and multiple arrangements using a wooden lath (for regular walls), suction cups (for glass surfaces) or metal wires for ceiling suspension.

Symmetrical in shape, a Stalactite can be hung one on each side of a glass wall for an even better acoustic experience. Imagine a grey interior for the conference room, and an orange exterior for the reception!



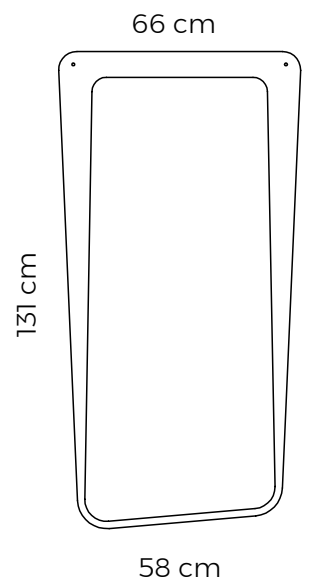
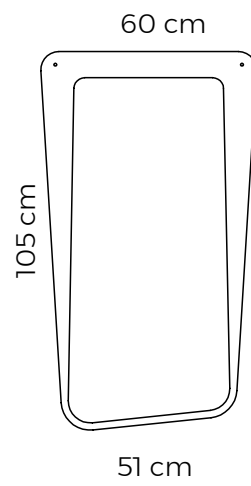
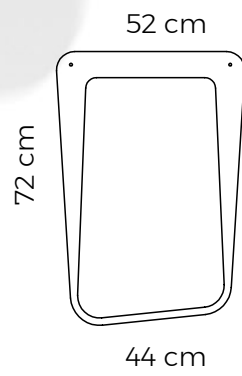



Up to three separate pieces can be attached to the wooden lath, and then slid along the length. A swift and simple operation, the Stalactite is mounted using the slidable metal clamp on the back, covered with a varnished wooden dowel on the front.

MIDDLE LAYER COLOR

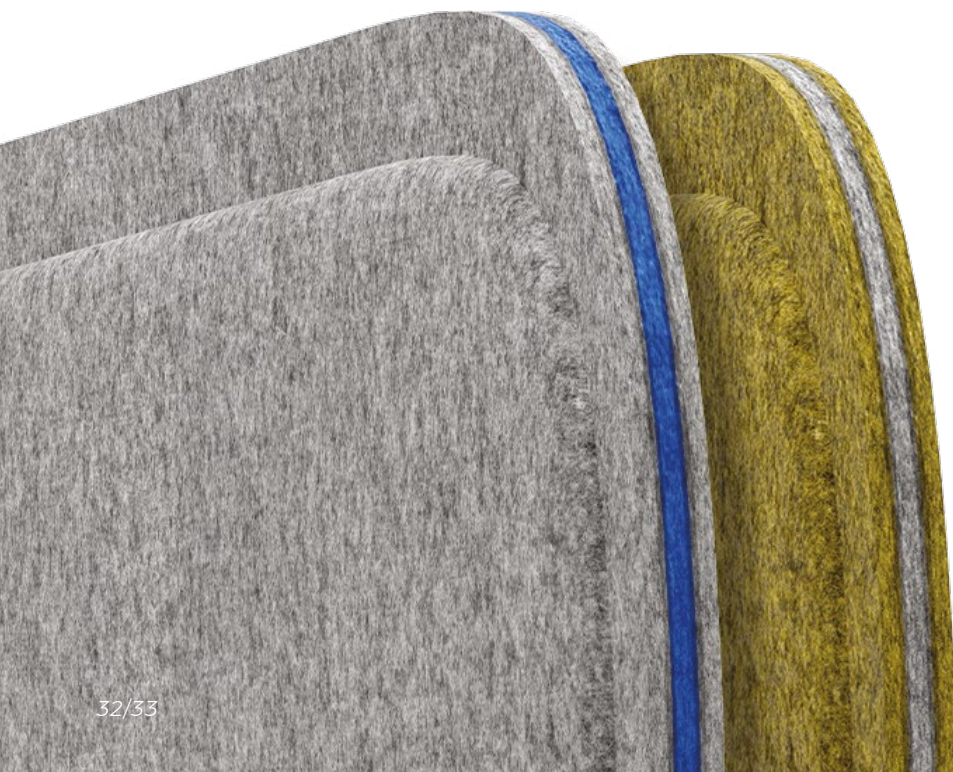

Stalactite lets you choose the colour of each of the three layers of its upholstery.

And thanks to the Acustio's signature solution, now even the hue of the inside layer can be selected. A myriad combinations can be achieved that will perfectly reflect the Client's branding and the emotions that it embodies.

COLOURS

CATEGORY A

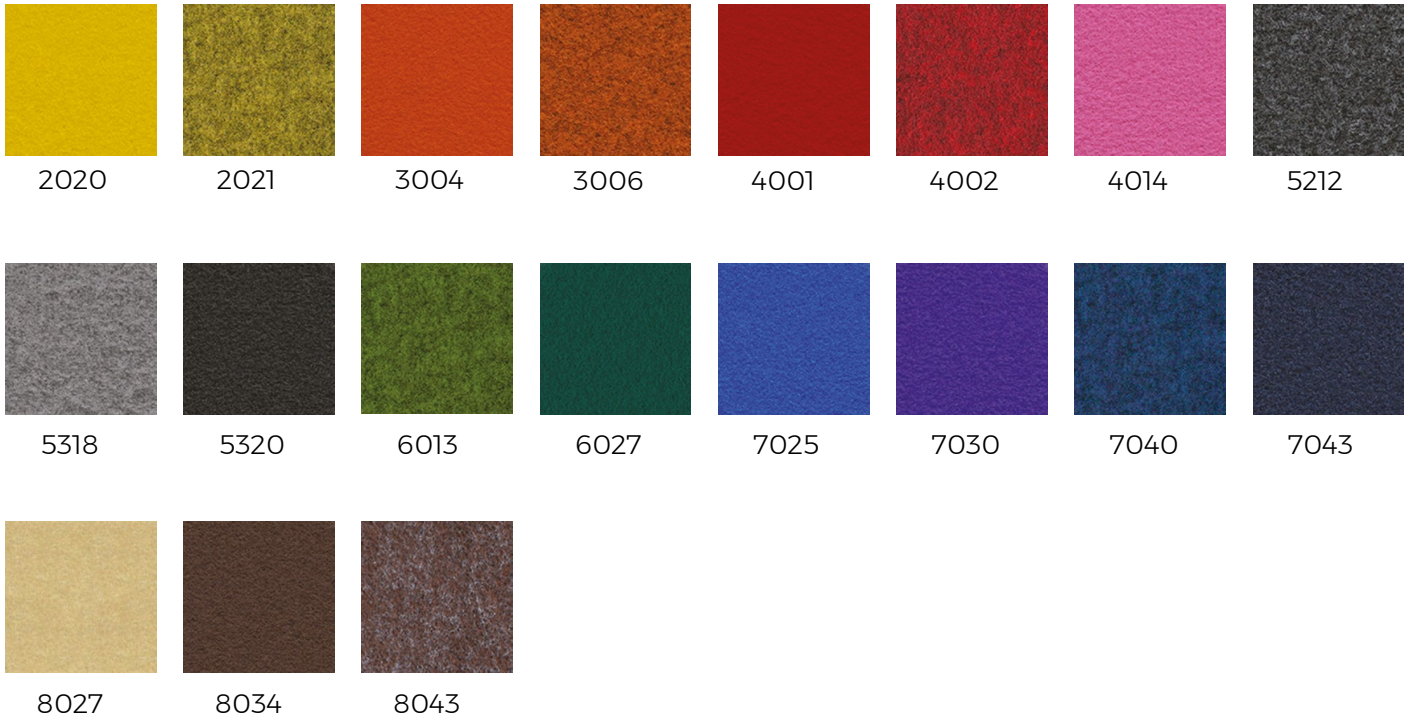

CATEGORY B



HEAVEN BOOTH

With extra-wide side edges that overlap for better acoustic performance, the flexible and modular Heaven Booth room divider means bindability at any angle. Walls can be assembled in minutes to form enclosures and partitions.

Heaven Booth is all about the binding technology. With nothing but simplicity in mind, the panels are connected using sturdy, plastic screws. This works perfectly, both sideways and in corners, given our specially designed, shortened feet for conflict-free bending.







With Acustio's innovative seamless technology, Heaven Booth's unique lateral outer edge has been widened to 6 cm creating a flexible hinge that allows users to bind neighbouring walls very tightly. Flexible and soundproof, this type of connection won't let any noise through. It is the peace and quiet you need.

MIDDLE LAYER COLOUR

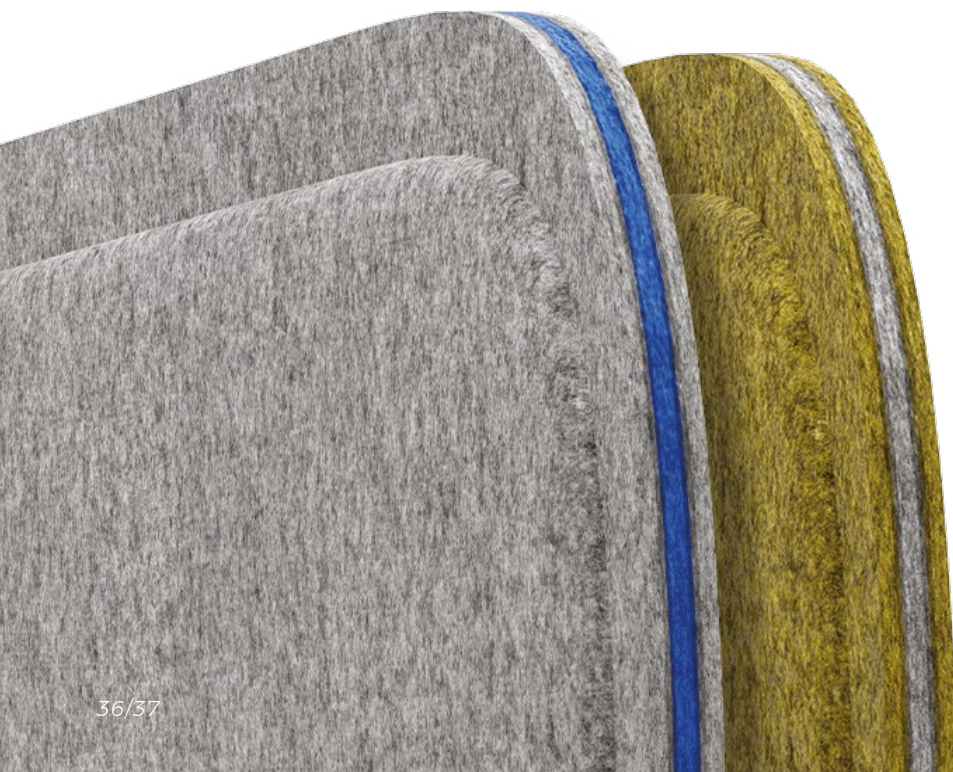

Heaven Booth lets you choose the colour of each of the three layers of its upholstery.

And thanks to the Acustio's signature solution, now even the hue of the inside layer can be selected. A myriad combinations can be achieved that will perfectly reflect the Client's branding and the emotions that it embodies.

COLOURS

CATEGORY A



2020



2021



3004



3006



4001



4002



4014

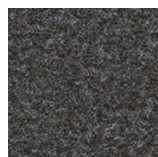

5212



5318

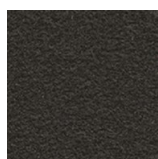

5320



6013



6027

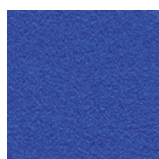

7025

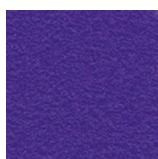

7030

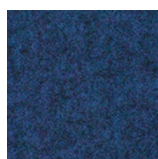

7040

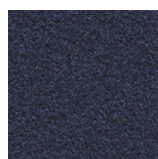

7043

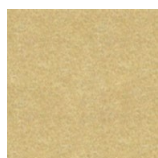

8027

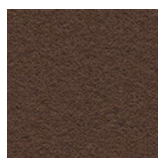

8034

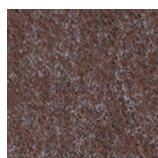

8043

SILENTUM

Silentum is Acustio's standalone, sound-diffusing pillar designed to corner unwanted noise in open spaces. Built using 18 dedicated Jasper panels, the 195-cm column features excellent sound absorption properties for more balanced acoustics. The choice of upholstery spans the entire Acustio felt collection and includes both synthetic fabric and natural wool.

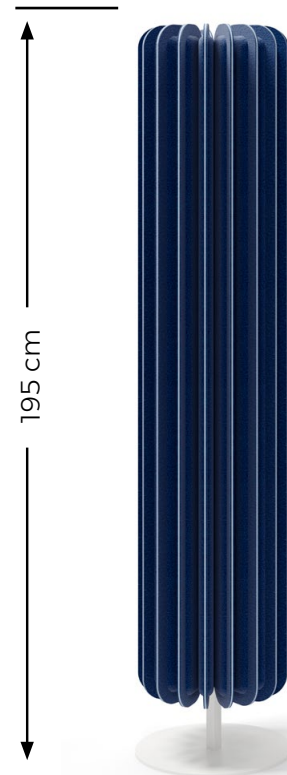
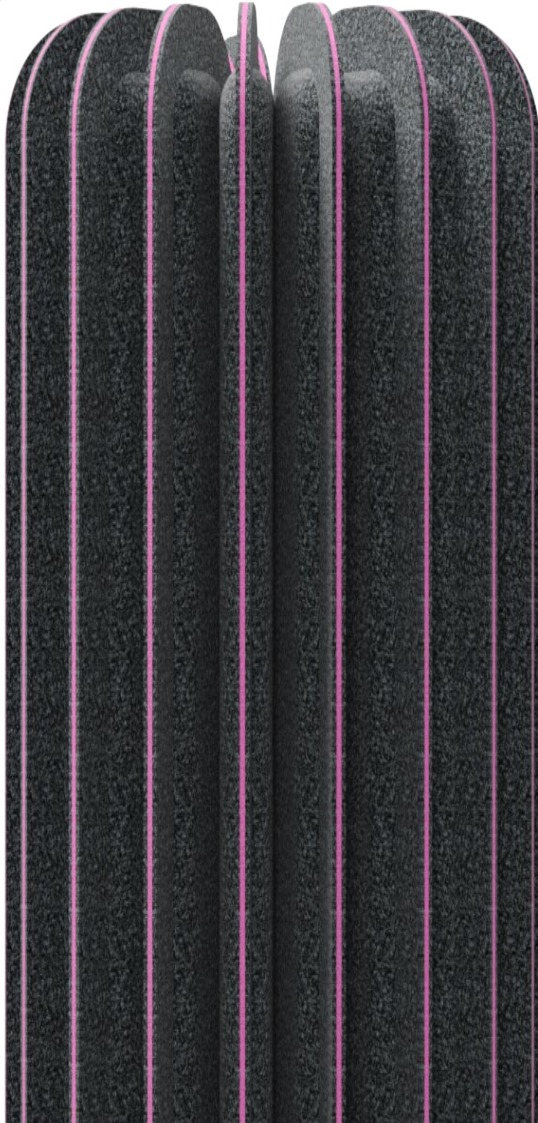
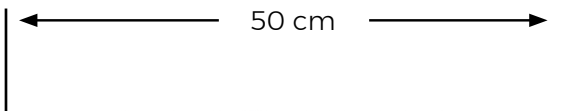

COLOURS

CATEGORY A

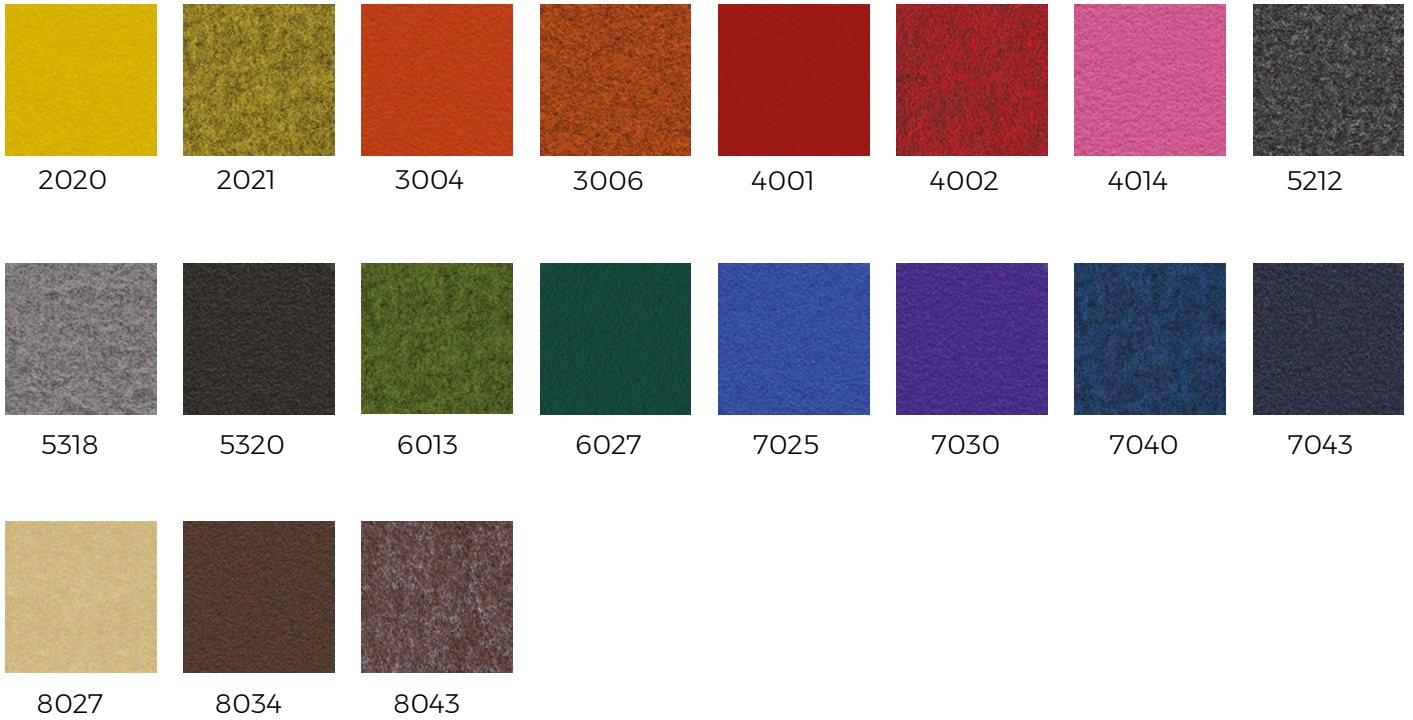

CATEGORY B



SKYSQUARE

Acustio's new square ceiling panels are the ultimate solution for offices with Armstrong suspended ceiling tiles. They allow for a very quick change of both look and feel of an entire office, and vastly improve its acoustic parameters.

Time-consuming and complicated replacements are now a thing from the past. The office will look and feel cozy in a just few hours! Available in a wide colour palette, our square ceiling panels are manufactured using Acustio's high-quality, fire-retardant category C felt.



L: 59,5 cm x W: 119,5cm x T: 5 cm

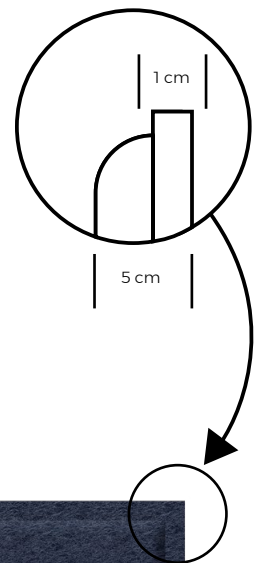

L: 59,5 cm x W: 59,5 cm x T: 5 cm

COLOURS

CATEGORY C

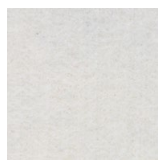

401

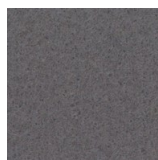

494

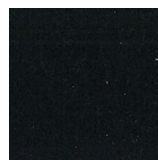

499



450

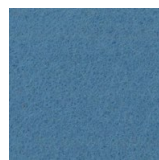

452

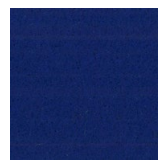

454

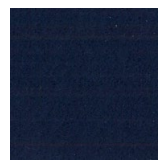

456



446



447

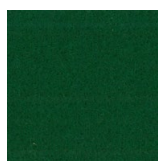

448



431

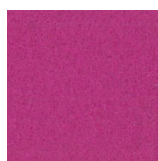

432

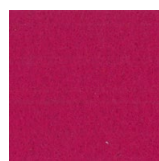

433



424



426

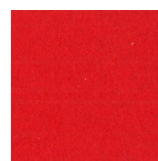

436

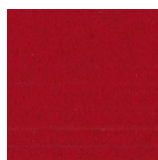

438

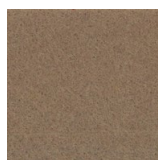

409

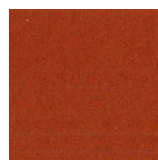

474

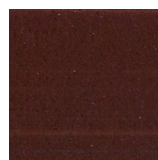

478

The reason
we like
silence
is that we
like to
listen.
And our
values are
simple.







All our projects are completed in cooperation
with top-tier national and global distributors.

Architects, designers and commercial real estate developers,
please contact us at marketing@acustio.com

Our global sales and support network is at your disposal
and will gladly provide further information and inspiration.